

Katun Products for use in

Konica

Table of Contents

	<i>Page</i>
Copy Machine Equivalency List	i
Descriptions of Katun Product Brands and Technologies	iii
Beschreibungen der Produktmarken und Technologien von Katun	v
Personalized Product Agreement	vii
Vereinbarung Über Bestellung Von Produkten Mit Ihrem Firmenetikett	ix
Bearings/Bushings	1
Belts	5
Blades/Brushes	6
Corona/Charge/Transfer	8
Developers	11
Feed/Delivery	13
Filters	18
Fuser Cleaning	19
Fuser Oil	21
Gears	22
Kits	23
Lamps	25
Memory Upgrades	26
Photoreceptors	27
Picker Fingers	30
Rollers, Fuser/Heat	31
Rollers, Pressure	34
Thermal Control Devices	36
Toners/Toner Cartridges	37
Waste Toner Containers	40
General Information	I
Allgemeine Hinweise	III
Distributor Choice Warranty Claim Form	V
HÄNDLER-GARANTIEFORMULAR	VII

Copy Machine Equivalency List

Central/Eastern Europe
 Telephone: 31(0)183-696969
 Fax: 31(0)183-629055
 E-mail: order@edc.katun.com

Konica	Develop	Kyocera Mita	Minolta	Utax
7015		Vi 150		CD 16
7060		Vi 550		CD 55
		Vi 600		
7075			Di 750	
7085		KM 8530	Di 850	
7115	D 1531 iD		Di 152	
7115 F	D 1536 iD		Di 152 f	
7118	D 1831 iD		Di 183	
7118 F	D 1836 iD		Di 183 f	
7155	D 5510 iD		Di 551	
7165	D 6500 iD		Di 650	
7216			DI 1611	
7220			DI 2011	
7255			DI 5510	
7272			DI 7210	
7415	D 1530 iD		Di 151	
7415 FAX	D 1530 iD F		Di 151 f	
7723	DFC 100	Ci 7500	CF 900	DCC 4000
7823	DFC 110	Ci 7600	CF 910	DCC 4400
7832	DFC 800		CF 9001	
7915	QC 1500	KM C 1530	CF 1501	
7920	QC 2000		CF 2001	
8020	QC 2001	KM C 2030	CF 2002	
8031	QC 3101	KM C 3130	CF 3102	
ColorFORCE 8050			CF 5001	
KL 5100			CF 5001	
AD- 723	AD- 7	AD- 55	AD- 7	AD- 55
AFR- 9	AFR- 9	RADF- 8	AFR- 9	RADF- 8
DB- 431	PF- 117		PF- 117	
DB- 432		PF- 620	PF- 121	
DF- 216	AF- 8		AF- 8	
DF- 217	AF- 10		AF- 10	
DF- 313		SRDF- 100	EDH- 2	
DF- 316	EDH- 4		EDH- 4	
DF- 317		DF- 317	EDH- 5	
DF- 331	AFR- 16		AFR- 16	
DF- 332		DU- 620	AFR- 18	
DF- 723	AFR- 9	RADF- 8	AFR- 9	RADF- 8
DF- 724	AFR- 12	RADF- 10	AFR- 12	RADF- 10
FIERY- X2 e	FIERY- X2 e	FIERY- X2 E	FIERY- X2 E	FIERY- X2 e
FIERY- X3 e	FIERY- X3 e	FIERY- X3 e	FIERY- X3 e	
FIERY- X4	FIERY- X4	FIERY- X4	FIERY- X4	FIERY- X4
FIERY- Z4			FIERY- Z4	
FIERY- Z5	FIERY- Z5		FIERY- Z5	
FS- 108		F- 8230	FN- 104	
FS- 108 B		F- 8330	FN- 4	
FS- 110	FN- 6		FN- 6	
FS- 111		DF- 630	FN- 115	
FS- 133	FN- 107		FN- 107	
FS- 134	FN- 108		FN- 108	
FS- 135		DF- 620	FN- 116	
FS- 210	FN- 113		FN- 112	
			FN- 113	

Copy Machine Equivalency List

Konica	Develop	Kyocera Mita	Minolta	Utax
FS- 211		DF- 635	FN- 7	
FS- 231		DF- 625	FN- 8	
IP- 413	Pi- 1802 e		Pi- 1802 e	
IP- 511	Pi- 6500		PI- 6500	
IP- 601			PI- 7500	
IP- 602		PRINT SYSTEM- 2	IP- 602	
KR- X2	FIERY- X2	FIERY- X2	FIERY- X2	FIERY- X2
KR- ZX 2100	FIERY- ZX 2100	FIERY- ZX 2100	FIERY- ZX 2100	FIERY- ZX 2100
KR- ZX 3300	FIERY- ZX 3300	FIERY- ZX 3300	FIERY- ZX 3300	FIERY- ZX 3300
LT- 401		ST- 4000	C- 305	
LT- 402	C- 403	LT- 402	C- 403	
LT- 411		ST- 4001	C- 305 L	
LT- 412	C- 404	LT- 412	C- 404	
LT- 723	C- 101	ST- 1100	C- 101	ST- 1100
MT- 102	MB- 5		MB- 5	
PF- 120	PF- 116		PF- 116	
PF- 121	PF- 120		PF- 120	
PF- 231	PF- 118	ST- 530	PF- 118	
PF- 232	PF- 118	ST- 530	PF- 118	
PPI- 108		CI- 1	COVER INSERTER- A	
ST- 134	JS- 1002		JS- 1002	
ST- 723	S- 105	AS- 1210	S- 105	AS- 1210
ST- 724	ST- 103	AS- S 2210	ST- 103	AS- S 2210
TU- 108		TU- 108	TMG- 2	

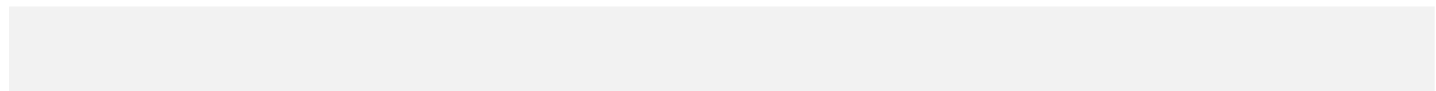
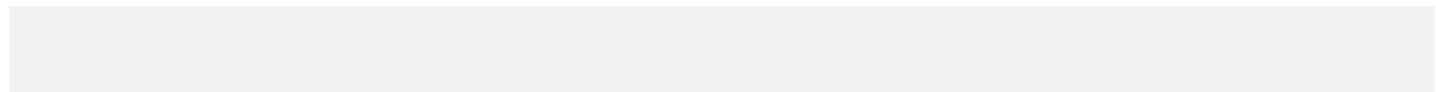
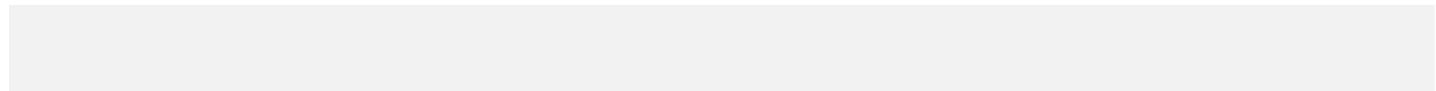
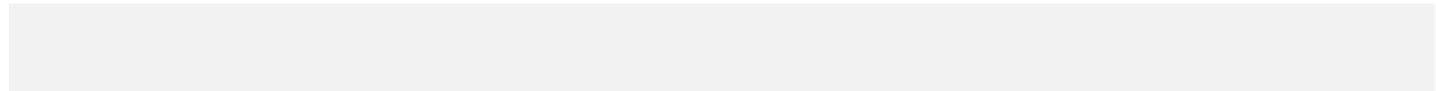
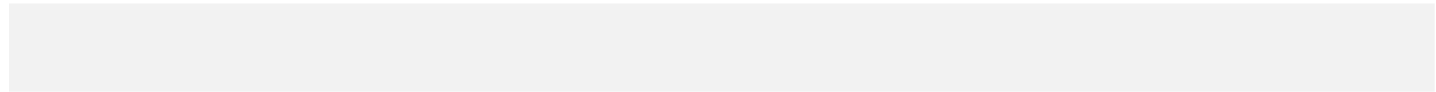

Descriptions of Katun Product Brands and Technologies

Katun Performance Products

Katun Performance is our complete line of office automation products that combine our highest quality level with consistent, reliable performance and competitive pricing - and provide excellent overall value.

Katun Performance products meet strict quality guidelines and have been 100% tested and approved according to the Katun 360° Certification process, which includes environmental testing, forward and reverse compatibility testing, model application testing, and component compatibility testing. In addition, all Katun Performance products are warranted to be free from functional defects in material and workmanship for one year and come with the highest level of Katun technical support.

To locate Katun Performance products, look for the Katun Performance icon  throughout this catalog.

Access by Katun Products

Access by Katun is a line of selected products that address the unique pricing or product needs of specific markets. Access by Katun products provide market acceptable quality and market competitive pricing. The Access by Katun product line complements the Katun Performance line by providing a value proposition based primarily on specific market needs.

Access by Katun products come with a limited level of product support and a one-year warranty. Although Access by Katun products provide some price advantages, remember that Katun Performance products always provide excellent overall value.

Original Products

Select OEM brand products that Katun offers to meet certain market needs

Fuser Roller Coating Technologies

Minco Manufacturing, Inc., a wholly owned subsidiary of Katun Corporation, is a world-leading manufacturer of fuser rollers for use in plain paper copiers, facsimiles, and printers. The product development relationship between Katun, Minco, and DuPont, the exclusive manufacturer of genuine TEFLON[®] brand coatings, has produced numerous advanced fuser roller coating technologies, including:

DURAPREM™II upper fuser rollers are manufactured with a heat-resistant, nonstick TEFLON[®] brand coating that provides increased surface hardness for extended potential life. A proprietary finishing process produces an exceptionally smooth surface, which contributes to these rollers' excellent fusing performance and toner release in machines using negative-charge toner.

DURACON™II upper fuser rollers are manufactured with a heat-resistant, nonstick TEFLON[®] brand coating that includes patented conductive additives for static dissipation. These rollers provide excellent fusing performance, toner release, and long life, primarily in machines using positive-charge toner.

ALUMANA™ upper fuser rollers are manufactured with extremely hard, tough primer and midcoat layers for maximum resistance to wear and abrasion. The ceramic ALUMANA coating combines a DuPont-patented polymer blend with reinforcing oxides for enhanced durability. These heavy-duty rollers are specifically designed to meet the demands of hostile fuser station environments and higher-speed machines using either positive-charge or negative-charge toner.

TRITON™II upper fuser rollers are manufactured with an advanced TEFLON[®] brand coating that provides improved fusing performance and nonstick characteristics in comparison to conventional fluoropolymer coatings. Unique static-dissipative particulates within the TRITON II coating, together with enhanced manufacturing processes, contribute to these rollers' superior abrasion-resistance and excellent toner release. These rollers provide extended potential life in selected machines using either positive-charge or negative-charge toner.

Central/Eastern Europe

Telephone: 31(0)183-696969

Fax: 31(0)183-629055

E-mail: order@edc.katun.com

TRITON BLUE™ upper fuser rollers deliver excellent performance for machine applications that are tough on fuser rollers. Manufactured with an advanced TEFLON® brand coating that provides improved fusing performance and nonstick characteristics in comparison to conventional fluoropolymer coatings, TRITON BLUE™ fuser rollers combine improved wear resistance with superior abrasion-resistance and excellent toner release.

TUF/SIL™ upper fuser rollers are manufactured with a layer of silicone rubber that effectively regulates heat flow to the toner, plus an outermost layer that consists of a specially blended TEFLON® brand coating providing excellent toner release and abrasion-resistance. This combination ensures reduced toner offsetting and improved, more consistent copy quality under certain demanding machine usage conditions. These rollers provide a high-performance, cost-effective solution for selected machines required to consistently produce the best possible copy quality.

MICROSLEEVE™ lower pressure rollers, with nonstick PFA sleeves 50, 70, or 100 microns in thickness, provide excellent wear-resistance for improved copy quality over an extended life. A-Series MICROSLEEVE™ lower pressure rollers are designed specifically for machines utilizing lower fuser cleaning rollers. Their unique surface texture reduces toner buildup and improves cleaning efficiency within the fuser station.

All Katun fuser rollers are designed specifically for their intended applications and manufactured to exacting quality standards, ensuring their excellent performance and long life.

Fuser Cleaning Roller Coating Technologies

Katun has introduced unique fuser cleaning roller technologies for machines requiring efficient removal and absorption of excess toner and contaminants, as well as continuous silicone oil lubrication of critical fuser station parts. For many machines, the ideal parts combination for achieving optimum copy quality and maximum parts life includes a specially designed Katun fuser cleaning roller.

FIBRA™ fuser cleaning rollers incorporate a uniform network of special fibers that aggressively remove excess toner and contaminants from the contacted surface. By efficiently depositing toner and contaminants beneath its outermost surface, the unique FIBRA network also helps maintain a continuous lubricative flow of silicone oil from the roller's internal tank to critical fuser station parts.

FIBRA™ II fuser cleaning rollers incorporate a unique configuration of highly heat-resistant fibers to greatly enhance cleaning performance, especially in hostile fuser station environments. Efficient absorption of excess toner and contaminants, together with continuous silicone oil lubrication of critical fuser station parts, effectively reduce parts and service expenses associated with the fuser station.

TEFLON® is a registered trademark of E.I. DuPont de Nemours and Company used under license by Katun Corporation.

Personalized Product Program

Katun offers an extremely cost-effective way for office equipment dealers/distributors to ensure repeat business and strengthen relations with customers. The **Personalized Product program** enables dealers/distributors to provide high-quality Katun Performance imaging supplies (toner, fax and printer toner cartridges, digital duplicator inks and masters and thermal transfer ribbons) with their business name and /or logo, plus contact information, so end-users always know whom to call to reorder. For a one-time, nominal set-up fee, Katun designs and produces full-color labels to customer specifications and applies them to packaging at no extra charge. Only end-user-replaceable Katun Performance products are eligible under the program. Enrollment is simple and easy. Just complete the agreement form and submit it to your Katun sales representative or visit the Personalized Products page for more program and enrollment information.



Beschreibungen der Produktmarken und Technologien von Katun

Katun Performance-Produkte

Katun Performance ist unsere umfangreiche Produktreihe von Büromaschinenprodukten, die sich durch hohe Qualität sowie durch beständige, zuverlässige Leistung und attraktive Preise auszeichnen. Mit diesen Produkten soll der Nutzwert für den Kunden maximiert werden.

Katun Performance -Produkte erfüllen strenge Qualitätsstandards und wurden alle im Rahmen des 360° -Zertifizierungsverfahrens von Katun getestet und freigegeben. Die Produkte durchlaufen dabei Prüfungen der Umweltverträglichkeit, der Kompatibilität, der Modellanwendungen und der Komponentenkompatibilität. Darüber hinaus wird bei allen Katun Performance-Produkten ein Jahr lang gewährleistet, dass diese frei von funktionalen Material- und Verarbeitungsfehlern sind. Selbstverständlich steht Ihnen auch der hochwertige technische Support von Katun zur Verfügung.

Um die Katun Performance-Produkte zu finden, halten Sie in diesem Katalog nach dem Namen Performance  und dem entsprechenden Symbol Ausschau.

Originalprodukte

Sie können verschiedene OEM-Produkte auswählen, die Katun aufgrund der Nachfrage auf dem Markt in sein Produktangebot aufgenommen hat.

Beschichtungstechnologien für Heizwalzen

Minco Manufacturing Incorporated, eine hundertprozentige Tochtergesellschaft der Katun Corporation, ist einer der weltweit führenden Hersteller von Heizwalzen für Kopierer, Faxgeräte und Drucker. Die enge Zusammenarbeit zwischen Katun, Minco und DuPont, dem alleinigen Hersteller originaler TEFLON® - Beschichtungen, hat zur Entwicklung von zahlreichen neuartigen Beschichtungsmaterialien für Heizwalzen geführt:

DURAPREM™II Heizwalzen sind mit einer temperaturbeständigen TEFLON® - Antihaf-Beschichtung ausgestattet und besitzen daher eine größere Oberflächenhärte für eine potenziell längere Lebensdauer. Die nach einem speziellen Finish-Verfahren hergestellte, außerordentlich glatte Walzenoberfläche bietet hervorragende Fixier- und Antihaf-Eigenschaften in Geräten mit negativ geladenem Toner.

DURACON™II Heizwalzen sind mit einer temperaturbeständigen TEFLON® - Antihaf-Beschichtung ausgestattet, der patentierte, elektrisch leitfähige Inhaltsstoffe beigemischt sind, um das Ableiten von sich bildender statischer Ladung zu ermöglichen. Diese Heizwalzen zeichnen sich durch ihre hervorragenden Fixier- und Antihaf-Eigenschaften sowie eine lange Nutzungsdauer aus, besonders in Geräten mit positiv geladenem Toner.

ALUMANA™ Heizwalzen besitzen eine äußerst harte, widerstandsfähige Grund- und Zwischenschicht für eine höchstmögliche Verschleißfestigkeit und Haltbarkeit. Die ALUMANA Keramiksicht beinhaltet eine patentierte Polymer-Mischung von DuPont mit Verstärkungsoxiden für eine erhöhte Widerstandsfähigkeit.

Diese robusten Heizwalzen sind speziell für anspruchsvolle Betriebsbedingungen in der Fixierstation und für schnellere Kopierer mit positiv oder negativ geladenem Toner konstruiert.

TRITON™II Heizwalzen zeichnen sich durch ihre hochwertige TEFLON® -Beschichtung aus, die herkömmlichen Fluorpolymer-Beschichtungen in Bezug auf Fixier- und Antihaf-Eigenschaften überlegen ist. Spezielle antistatisch wirkende Partikel in der TRITON II-Beschichtung und hohe Fertigungsstandards tragen zu den ausgezeichneten Antihaf-Eigenschaften und der hervorragenden Verschleißfestigkeit dieser Heizwalzen bei.

Sie bieten potentiell längere Laufzeiten in ausgewählten Geräten sowohl mit positiv als auch mit negativ geladenem Toner.

Central/Eastern Europe

Telephone: 31(0)183-696969

Fax: 31(0)183-629055

E-mail: order@edc.katun.com

TUF/SIL™ Heizwalzen besitzen eine Silikonbeschichtung, die für eine effiziente regulierte Wärmeableitung an den Toner sorgt, sowie eine besonders zusammengesetzte TEFLON® - Beschichtung mit ausgezeichneten Antihaft-Eigenschaften und hoher Verschleißfestigkeit. Dies führt zu weniger Toner-Offsetting-Problemen und gewährleistet auch unter anspruchsvollen Betriebsbedingungen eine gleichbleibend hohe Kopienqualität. Die TEFLON®/SILIKON Heizwalzen bieten ein sehr gutes Preis-/Leistungsverhältnis für ausgewählte Geräte, die höchste Qualitätsansprüche in Bezug auf die Kopienqualität stellen.

MICROSLEEVE™ Presswalzen mit Antihaft-PFA-Ummantelung in den Stärken 50, 70 und 100 µm bieten eine außergewöhnliche Haltbarkeit und damit eine langfristig bessere Kopienqualität und längere Nutzungsdauer. Die Presswalzen der MICROSLEEVE™ A-Serie sind speziell für den Einsatz in Geräten gedacht, bei denen eine Reinigung der unteren Presswalze mittels Reinigungswalze stattfindet.

Ihre besondere Oberflächenstruktur reduziert Tonerablagerungen und verbessert die Reinigungswirkung in der Fixierstation.

Alle Heizwalzen von Katun wurden speziell im Hinblick auf deren Einsatzzweck entwickelt und erfüllen höchste Qualitätsstandards. Nicht umsonst zeichnen sie sich durch eine herausragende Leistung und eine lange Nutzungsdauer aus.

Beschichtungstechnologien für Reinigungswalzen

Katun hat spezielle Reinigungswalzen für Geräte entwickelt, die eine wirksame Beseitigung von Tonerresten und Schmutz sowie eine kontinuierliche Versorgung wichtiger Teile der Fixierstation mit Silikonöl erfordern. Durch den Einsatz einer Katun Reinigungswalze kann bei vielen Geräten eine optimale Kopienqualität und eine größtmögliche Nutzungsdauer der Komponenten erzielt werden.

FIBRA™ Reinigungswalzen entfernen Tonerreste und Schmutzpartikel durch ein spezielles Fasernetz effizient von der Walzenoberfläche. Während das FIBRA-Fasernetz die Verschmutzungen wirkungsvoll in seiner Oberfläche aufnimmt, sorgt es zugleich für eine Dauerversorgung wichtiger Teile der Fixierstation mit Silikonöl aus dem Vorratstank im Walzeninneren.

FIBRA™II Reinigungswalzen besitzen ein neuartiges, hitzebeständiges Fasernetz, mit denen besonders unter anspruchsvollen Betriebsbedingungen eine erheblich verbesserte Reinigungswirkung erzielt wird.

Durch die wirksame Aufnahme von Tonerresten und Schmutzstoffen bei gleichzeitiger Dauerversorgung wichtiger Teile in der Fixierstation mit Silikonöl können die Austausch- und Servicekosten für die Fixierstation erheblich gesenkt werden.

TEFLON® ist ein eingetragenes Warenzeichen von E.I. DuPont de Nemours and Company und wird von der Katun Corporation unter Lizenz verwendet.

Firmenetiketten-Programm

Katun bietet Händlern einen äußerst kostengünstigen Weg, ihre Kunden an sich zu binden und Kundenbeziehungen zu verbessern. Das **Firmenetiketten-Programm** erlaubt es Händlern, qualitativ hochwertige Verbrauchsmaterialien von Katun Performance (Toner, Drucker-/Faxkartuschen, Tinten für Digitalkopierer und Thermotransferrollen) mit ihrem Firmennamen und/oder Logo sowie mit Kontaktinformationen zu versehen. So wissen Verbraucher immer, bei wem sie Produkte nachbestellen können. Für eine einmalige, geringe Bearbeitungsgebühr entwirft und produziert Katun Performance vollfarbige Etiketten nach Ihren eigenen Angaben. Diese werden kostenfrei auf die entsprechenden Verpackungen aufgebracht. Unter dieses Programm fallen nur Produkte, die vom Endverbraucher nachbestellt werden können. Die Teilnahme an dem Programm ist ganz einfach. Füllen Sie einfach die Vereinbarung aus und senden Sie diese an Ihren Katun- Ansprechpartner oder besuchen Sie uns auf unserer Homepage unter Firmenetiketten-Programm für weitere Information zu diesem Programm und den Teilnahmebedingungen.



Personalized Product Agreement

Customer Information

Customer Number: _____ Phone Number: _____
 Contact Name: _____ Fax Number: _____
 Title: _____ Katun Representative: _____

Customer agrees to:

- Provide pertinent information, a scanable copy of your company logo, or other desired label artwork, and color specifications for the labels.
- Pay a one-time, nominal setup fee upon approval of the label design. (Ask your sales representative for details.)
- Order in full master carton quantities.

Katun agrees to:

- Create a personalized, full-color label design to your specifications, per the information provided on page two of this form, for a one-time, nominal setup fee and send a proof for approval within a minimum of 7 days of receipt of this agreement.
- Produce labels printed with the customer's approved design on white label stock, and affix them over the Katun Performance logo* on copier toner, printer/fax toner cartridge, digital duplicator ink/master packaging.
- Ship initial order within one week after the customer approves their Personalized Product label proof. Reorders will also ship within one week.

Projected Personalized Product Purchases

<i>Katun Part Number**</i>	<i>OEM Line</i>	<i>Product/Model Description</i>	<i>Minimum Order Quantity</i>	<i>Projected Monthly Order***</i>
P			<i>One master carton</i>	
P			<i>One master carton</i>	
P			<i>One master carton</i>	
P			<i>One master carton</i>	
P			<i>One master carton</i>	
P			<i>One master carton</i>	

Signature: _____ Date: _____

*Only Katun Performance products can be personalized.

**The Personalized Product part number is the regular Katun Performance part number with a 'P' added at the end. See the Katun catalog for master carton quantities.

*****Projection only.** You are not committed to ordering the quantity you list on this form.

NOTE: Products with personalized labels cannot be returned to Katun for credit unless a valid warranty claim exists.

Please Also Complete Page 2



Central/Eastern Europe

Telephone: 31(0)183-696969

Fax: 31(0)183-629055

E-mail: order@edc.katun.com

Information for Personalized Product Label

Please list *only* the information you want to appear on your Personalized Product label.

Company Name: _____

Street Address: _____

City: _____

State/Province: _____ **Postal Code:** _____

Phone Number: _____ **Fax Number:** _____

Other: _____

Label Artwork

- **Attach a copy of your company logo and/or any other requested graphic elements.** Artwork may be full color or black and white. We prefer original-quality artwork 4" x 4" (100mm x 100mm) or larger, but will accept a business card or sheet of company letterhead.
- **Please indicate your color preferences.** In the space below, please indicate the color(s) you want to use for all text, your company logo, and any other graphic elements. If appropriate, please supply accurate samples to be matched or specify Pantone or PMS color numbers. **NOTE:** Your labels will be printed on a thermal-transfer printer at a resolution of 300 dpi. Therefore color photographs cannot be printed and some colors may be difficult to match precisely.

Label Sizes

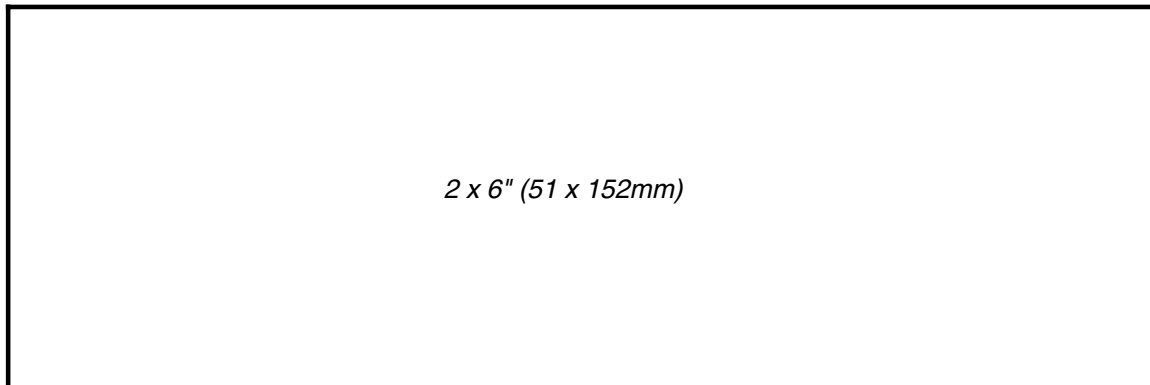
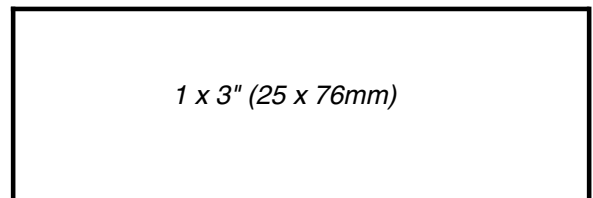
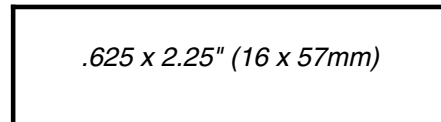
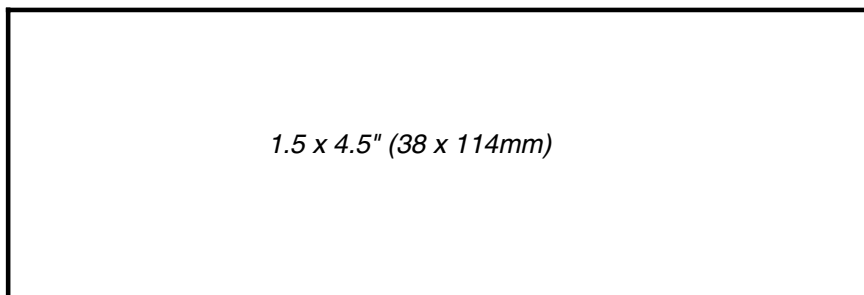

Vereinbarung über Bestellung von Produkten mit Ihrem Firmenetikett

Kundeninformationen

Kundennummer: _____ Telefon: _____
 Ansprechpartner: _____ Fax: _____
 Position: _____ Ihr Katun-Repräsentant: _____

Der Kunde ist einverstanden:

- Katun die benötigten Informationen vorzulegen (ein zum Scannen geeignetes Muster Ihres Firmenlogos bzw. Muster anderer gewünschter Grafikelemente sowie Farbspezifikationen für die Etiketten);
- nach Genehmigung des Etiketten-Layouts eine einmalige, geringe Bearbeitungsgebühr zu entrichten. Weitere Informationen erhalten Sie von Ihrem Katun-Repräsentanten;
- Toner in den jeweiligen Verpackungseinheiten/Umkartons zu bestellen.

Katun verpflichtet sich:

- ein Vollfarbetikett nach den Kundenangaben zu entwerfen (siehe Seite 2 dieses Formulars). Hierfür wird eine einmalige, geringe Bearbeitungsgebühr erhoben. Nach Eingang dieser Vereinbarung bei Katun erhält der Kunde innerhalb von ca. sieben Werktagen einen Korrekturabzug.
- Etiketten in Standardgröße mit dem vom Kunden genehmigten Layout auf weißem Etikettenpapier zu drucken und über dem Katun Performance-Logo* auf der Verpackung von Toner für Kopierer, Tonerkartuschen für Drucker/Faxgeräte, Tinte bzw. deren Umkartons für digitale Duplikatoren anzubringen.
- den Toner-Erstauftrag innerhalb von einer Woche nach Genehmigung des firmeneigenen Etiketts zu versenden. Nachbestellungen werden ebenfalls innerhalb einer Woche erledigt.

Erwartete Abnahmemenge von Produkten mit Ihrem Firmenetikett

Katun Artikelnummer**	Maschinenlinie	Produkt-/Modellbeschreibung	Mindestmenge	Erwartete monatliche Bestellung***
P			Ein Umkarton	
P			Ein Umkarton	
P			Ein Umkarton	
P			Ein Umkarton	
P			Ein Umkarton	
P			Ein Umkarton	

Unterschrift: _____ Datum: _____

*Nur Katun Performance Produkte können mit Firmenetiketten bestellt werden.

**Die Artikelnummer für Produkte mit Ihrem Firmenetikett ist die normale Katun Performance Artikelnummer, der ein "P" am Ende nachgestellt ist. Sehen Sie die Umkartonmengen im Katun-Katalog nach.

***Nur Schätzungen. Sie sind nicht verpflichtet, die hier angegebene Menge abzunehmen.

HINWEIS: Produkte mit Firmenetiketten können nur bei einer berechtigten Reklamation gutgeschrieben werden.

Füllen Sie bitte auch Seite 2 aus.

Bestellinformationen für firmeneigenes Etikett

Geben Sie bitte *nur* die Informationen an, die auf dem Etikett erscheinen sollen.

Name der Firma: _____

Strasse: _____

PLZ/Ort: _____

Telefon: _____ Fax: _____

Sonstiges: _____

Layout des Etiketts

- **Bitte legen Sie kein Muster Ihres Firmenlogos sowie ggf. Muster anderer gewünschter Grafikelemente bei.** Geeignet sind Grafiken in Farbe oder Schwarzweiß, vorzugsweise Originale mit einer Mindestgröße von 100 x 100 mm. Wir können auch Ihre Visitenkarte oder Ihren Briefkopf verarbeiten.
- **Bitte geben Sie die gewünschten Farben an.** Tragen Sie unten bitte die Farbe(n) für alle Textelemente, Ihr Firmenlogo sowie andere grafische Elemente ein. Legen Sie ggf. ein Farbmuster bei, oder geben Sie die Pantone- bzw. PMS-Farbnummern an.
HINWEIS: Ihre Firmenetiketten werden auf einem Thermodrucker mit einer Auflösung von 300 DPI erstellt. Es können daher keine Farbfotos gedruckt werden, und bestimmte Farben können u. U. nicht exakt wiedergegeben werden.





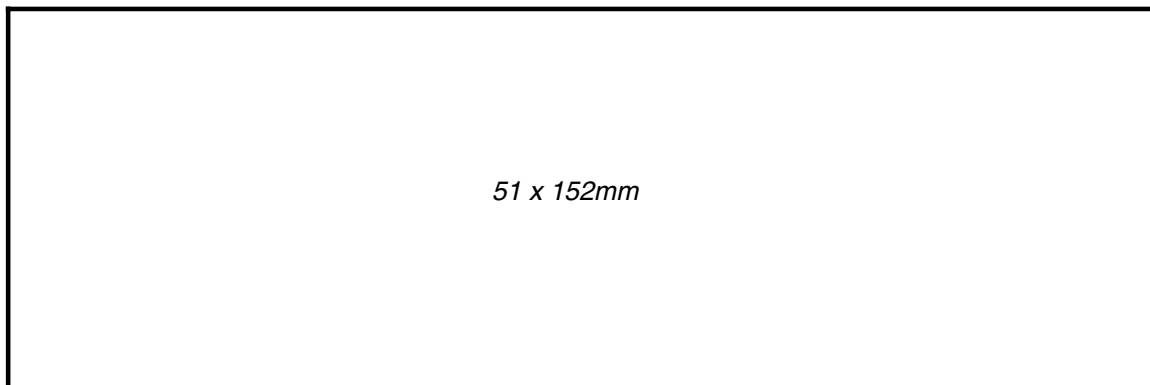
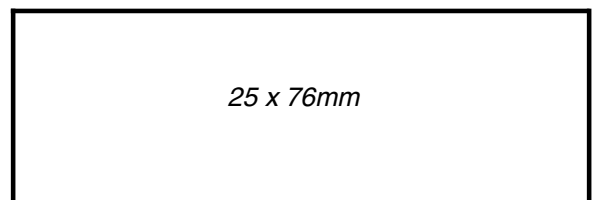
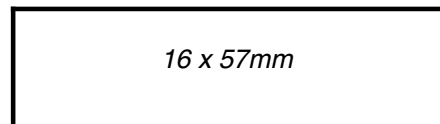
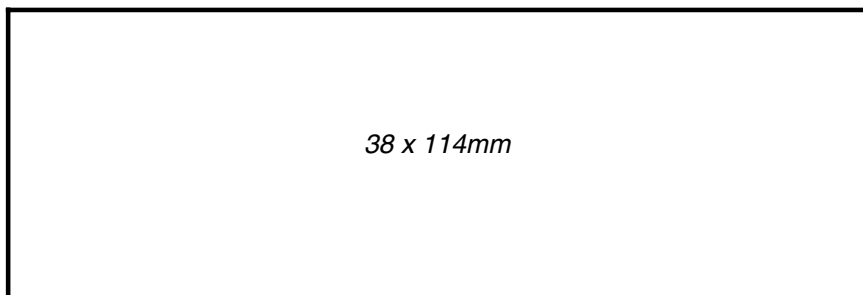









Etikettengrößen



For use in
Konica
Copiers













Central/Eastern Europe
Telephone: 31(0)183-696969
Fax: 31(0)183-629055
E-mail: order@edc.katun.com

OEM PN	KATUN PN	DESCRIPTION	MODEL NO.
Bearings/Bushings			
508053410	65576233 	Bearing Various Applications Lower Fuser Roller	5370 M, 7075, 7085, LT- 202 1015, 1020, 1120, 1212, 1216, 2223, UBIX 115 Z
392053360	65576118 	Bearing Various Applications Lower Fuser Roller	7075, 7085, DF- 203, DF- 310 1112, UBIX 112, UBIX 112 Z
113620670	65576118 	Bearing	1120, 1212, 1216, 2223, 4060, 4065, 5082, 5370, 5370 M, 6192, 7033, 7040, 7045, 7075, 7085, UBIX 600 ZA, UBIX 700 ZA, UBIX 700 ZR, UBIX 760 ZA, FS- 111, FS- 211
26AA53160	65016005 	Bearing Upper Fuser Roller Fuser Auxiliary Roller	1120, 2223 7075, 7085
322054250	65576263 	Heat Insulating Sleeve	1790, 2028, 2125, 2590, 3031, 3035, 3135, 7728, 8010, 8028, 9028, UBIX 150, UBIX 150 Z, UBIX 170 Z, UBIX 180 RE, UBIX 180 Z, UBIX 181 ZA, UBIX 220 Z, UBIX 225 Z, UBIX 250 Z, UBIX 280 Z, UBIX 320 Z, UBIX 321 Z
450075020	65576225 	Upper Fuser Roller Bearing	1790, 2028, 2125, 2590, 3031, 3035, 3135, 7728, 8010, 8028, 9028, UBIX 170 Z, UBIX 225 Z, UBIX 250 Z, UBIX 320 Z, UBIX 321 Z
540076050	65576233 	Bearing Various Applications	2028, 2125, 3031, 3035, 3135, 4045, 4145, 4155, 4255, 5370, 5370 M, 6192, 7020, 7022, 7025, 7030, 7035, 7130, 7135, 7145, DF- 309, DF- 316, FS- 103 B, FS- 104 A, FS- 108, LT- 351, LT- 352, LT- 401, LT- 402, LT- 411, LT- 412
300075020 <i>Final Inventory</i>	65576236 	Lower Fuser Roller Bearing	2028, 2590, 3035, 4045, 7728, 8028, 9028, UBIX 160, UBIX 160 RE, UBIX 180 RE, UBIX 180 Z, UBIX 181 ZA, UBIX 220 Z, UBIX 225 Z, UBIX 250, UBIX 250 Z, UBIX 280 Z, UBIX 320 Z, UBIX 321 Z, UBIX 404
460075060 <i>Final Inventory</i>	65576236 	Lower Fuser Roller Bearing	2028, 3035, 4045, UBIX 404
40AA53151	65018657 	Lower Fuser Roller Bearing	3231, 3240, 3331, 3340
40AA53510	65014269 	Heat Insulating Sleeve	3231, 3240, 3331, 3340
40AA75010	65576216 	Upper Fuser Roller Bearing	3231, 3240, 3331, 3340

*Priced per Heat Sleeve,
sold in Bags of 10.*



















*Priced per Heat Sleeve,
sold in Bags of 10.*









OEM PN	KATUN PN	DESCRIPTION	MODEL NO.	
Bearings/Bushings				
454053391	65014269 	Heat Insulating Sleeve Various Applications Upper	4045, 4060, 4065, 4145, 4155, 4255, 4345, 4355, 5082, 7033, 7040, 7050, 7060, 7085, UBIX 600 ZA, UBIX 700 ZA, UBIX 700 ZR, UBIX 760 ZA 5370, 5370 M, 6192, 7045, 7055, 7065, 7075, 7150, 7155, 7165, 7255, 7272, ColorFORCE 8050, KL 5100	<i>Priced per Heat Sleeve, sold in Bags of 10.</i>
454075040	65576216 	Upper Fuser Roller Bearing	4045, 4060, 4065, 4145, 4155, 4255, 4345, 4355, 5082, 5370, 5370 M, 6192, 7050, 7055, 7060, 7065, 7075, 7085, 7150, 7155, 7165, 7255, 7272, ColorFORCE 8050, KL 5100, UBIX 600 ZA, UBIX 700 ZA, UBIX 700 ZR, UBIX 760 ZA	
454075070	65576204 	Bearing	4060, 4065, 5082, 5370, 5370 M, 6192, 7075, 7085, UBIX 600 ZA, UBIX 700 ZA, UBIX 700 ZR, UBIX 760 ZA, DF- 302, DF- 303, DF- 303 A, DF- 304, DF- 401	
318075100	65021524 	Lower Fuser Roller Bearing	4060, 4065, 5082, UBIX 200, UBIX 200 R, UBIX 305 R, UBIX 330, UBIX 450, UBIX 450 R, UBIX 500 Z, UBIX 550 ZA, UBIX 600 ZA, UBIX 700 ZA, UBIX 700 ZR, UBIX 760 ZA	
066077020	65576233 	Bearing	4065, 5370, 6192, 7075, 7085, 7728, 8028, 9028, UBIX 700 ZA, UBIX 700 ZR, AD- 301, AD- 302, AD- 303, AD- 303 A, DF- 203, DF- 204, DF- 302, DF- 303, DF- 303 A, DF- 304, DF- 305, DF- 307, DF- 307 M, DF- 308, DF- 401, FS- 101, FS- 108, FS- 108 B, FS- 111, FS- 211, MT- 101, PF- 301, ST- 102, ST- 103, ST- 207, ST- 208, ST- 297, TU- 108	
25BA76030	65021522 	Lower Fuser Roller Bearing	4155, 4255, 4345, 4355, 7050, 7060, 7065, 7150	
25AA75020	65576209 	Lower Fuser Roller Bearing	5370, 5370 M, 6192	
35920130	65576233 	Lower Fuser Roller Bearing Lower Fuser Roller	7015	
60912270	65576233 	Bearing Various Applications	7015	
26NA53590	65576233 	Lower Fuser Roller Bearing	7020, 7022, 7025, 7030, 7035, 7130, 7135, 7145, 7222, 7228, 7235	
26NA53720	65019748 	Heat Insulating Sleeve A	7020, 7022, 7025, 7030, 7035, 7130, 7135, 7145, 7222, 7228, 7235	
26NA53730	65019749 	Heat Insulating Sleeve B	7020, 7022, 7025, 7030, 7035, 7130, 7135, 7145, 7222, 7228, 7235	
26NA53710	65021630 	Upper Fuser Roller Bearing	7020, 7022, 7025, 7030, 7035, 7130, 7135, 7145, 7222, 7228, 7235, ColorFORCE 8050, KL 5100	

For use in
Konica
Copiers

Central/Eastern Europe
Telephone: 31(0)183-696969
Fax: 31(0)183-629055
E-mail: order@edc.katun.com

OEM PN	KATUN PN	DESCRIPTION	MODEL NO.
Bearings/Bushings			
4401 951870	65021587 	Heat Insulating Sleeve 2 Heat Sleeves / Heat Sleeve	7024
			<i>Priced per Heat Sleeve, sold in Bags of 2.</i>
4401 952220	65576205 	Lower Fuser Roller Bearing	7024
4407 548060	65576225 	Upper Fuser Roller Bearing	7024
4408 510800	65576233 	Bearing	7024
55GA75020	65576216 	Upper Fuser Roller Bearing	7033, 7040, 7045
55GA75040	65018657 	Lower Fuser Roller Bearing	7033, 7040, 7045
55TA75020	65576203 	Bearing	7055, 7075, 7085
25SA76030	65021522 	Lower Fuser Roller Bearing	7055, 7155, 7165, 7255, 7272
08AA76060	65576205 	Bearing	7075, 7085, ColorFORCE 8050, KL 5100
326020280	65576205 	Bearing	7075, 7085, UBIX 400 Z, UBIX 404, UBIX 420 Z
25TU75700	65576209 	Fuser Roller Bearing	7723, 7823, 7832
12ZL75080	65576233 	Bearing Various Applications	7723, 7823, 7832, 7915, 7920, 8020, 8031, AFR- 9, DF- 331, DF- 723, DF- 724, FS- 133, FS- 134
25TU75440	65576233 	Bearing Various Applications	7723, 7823, 7832, 7915, 7920, 8020, 8031, AFR- 9, DF- 331, DF- 723, DF- 724, FS- 133, FS- 134
50331060	65576233 	Bearing	7915
4969-1043-01	65021630 	Lower Fuser Roller Bearing	ColorFORCE 8050, KL 5100
0200-2060	65576131 	Bearing	UBIX 100
020075031	65021524 	Lower Fuser Roller Bearing	UBIX 100
098053050	65021531 	Lower Fuser Roller Bearing	UBIX 120
300075040	65576107 	Bearing Various Applications	UBIX 160, UBIX 160 RE, UBIX 250







OEM PN	KATUN PN	DESCRIPTION	MODEL NO.
Bearings/Bushings			
1320-4150	65576107 	Bearing	UBIX 200, UBIX 200 R, UBIX 305 R, UBIX 330
312075010	65576205 	Bearing	UBIX 250
312075030	65576233 	Bearing Various Applications	UBIX 250
172075020	65576233 	Bearing	UBIX 404, UBIX 500 Z, UBIX 550 ZA, AF- 302, DF- 310
172075010	65576204 	Bearing	UBIX 500 Z, UBIX 550 ZA, AF- 302
12ZL75070	65576118 	Bearing	AFR- 9, DF- 331, DF- 723, DF- 724
074075010	65576204 	Bearing	ST- 206, ST- 211





















For use in
Konica
Copiers

Central/Eastern Europe
Telephone: 31(0)183-696969
Fax: 31(0)183-629055
E-mail: order@edc.katun.com

OEM PN	KATUN PN	DESCRIPTION	MODEL NO.
Belts			
12ZL11450	65014361 	Original Document Feed Belt	AFR- 9, DF- 723, DF- 724
048045010	65009370 	Original Document Feed Belt	DF- 203, DF- 204, DF- 305, DF- 308
12ER45011	65012538 	Original Document Feed Belt	DF- 306, DF- 310
12EV22290	65018127 	Original Document Feed Belt	DF- 402









OEM PN	KATUN PN	DESCRIPTION	MODEL NO.
Blades/Brushes			
25HA-2132	65018631 	Drum Cleaning Blade	1015, 1120, 1212, 1216, 2223
25HA-2132	65022573	Drum Cleaning Blade Access By Katun	1015, 1120, 1212, 1216, 2223
0294-2040	65000400 	Drum Cleaning Blade Assembly Supporting Plate not Included	1020, UBIX 115 Z
587020091	65010505 	Drum Cleaning Blade	1112
4660-2070	65244514 	Drum Cleaning Blade	1790, 2590, UBIX 170 Z, UBIX 250 Z
5400-2013	65015754 	Toner Guide Assembly	2028, 2125, 3031, 3035, 3135, 4045, 4145
5400-2123	65012746 	Drum Cleaning Blade	2028, 2125, 3031, 3035, 3135, 4045, 4145, 4155, 4255
40AA-2110	65016882 	Drum Cleaning Blade Assembly	3231, 3240, 3331, 3340
45AA-2250	65014110 	Drum Cleaning Blade	4345, 4355
25AA56015	65016765 	Drum Cleaning Blade	5370, 5370 M, 6192
35993432	65019969 	Drum Cleaning Blade	7015
26NA-2090	65019755 	Drum Cleaning Blade	7020, 7025, 7030
26TA-2090	65019755 	Drum Cleaning Blade Assembly	7022, 7035, 7130, 7135, 7145, 7222, 7228, 7235
4402 039580	65010154 	Upper Fuser Roller Cleaning Blade	7024
BL 2460 D	65018663 	Drum Cleaning Blade	7024
55GA56010	65017375 	Drum Cleaning Blade	7033, 7040, 7045
25SA-2083	65021573 	Toner Collection Assembly	7050
55WA20020	65021730 	Drum Cleaning Blade	7050, 7055, 7060, 7065, 7150
55WA-2040	65021573 	Toner Collection Assembly	7055, 7060, 7065, 7150
55VA56010	65019787 	Drum Cleaning Blade	7075











For use in
Konica
 Copiers

Central/Eastern Europe
 Telephone: 31(0)183-696969
 Fax: 31(0)183-629055
 E-mail: order@edc.katun.com













OEM PN	KATUN PN	DESCRIPTION	MODEL NO.
Blades/Brushes			
55VA-5741 <i>Final Inventory</i>	65021534 	Toner Guide Brush Assembly	7075, 7085
56GA56010	65019787 	Drum Cleaning Blade	7085
27AE27010	65021876 	Drum Cleaning Blade	7115, 7115 F, 7118, 7118 F
56AA20100	65021874 	Drum Cleaning Blade	7155, 7165, 7255, 7272
25TU55400	65018830 	Drum Cleaning Blade	7723, 7823, 7832
1136-2041	65243414 	Drum Cleaning Blade Assembly Supporting Plate not Included	UBIX 112, UBIX 112 Z
3227-5600	65243417 	Drum Cleaning Blade	UBIX 180 RE, UBIX 180 Z, UBIX 181 ZA, UBIX 220 Z, UBIX 280 Z, UBIX 320 Z, UBIX 321 Z













OEM PN	KATUN PN	DESCRIPTION	MODEL NO.
Corona/Charge/Transfer			
540026080	65000834 	Corona Wire 60μ Oxidized Transfer, Separation	2028, 2125, 3031, 3035, 3135, 4045, 4145, 4155, 4255, 4345, 4355 <i>Priced per Set, 10 Corona Wires per Set.</i>
N/P/N	65011002 	Corona Wire Spool 50 m / Spool 60μ Oxidized Various Applications	2028, 2125, 3031, 3035, 3135, 4045, 4145, 4155, 4255, 4345, 4355, 7050
N/P/N	65000834 	Corona Wire 60μ Oxidized Charge	3035, 3135, 4045, 4145, 4155, 4255, 4355 <i>Priced per Set, 10 Corona Wires per Set.</i>
N/P/N	65375549 	Grid Wire Spool 50 m / Spool 100μ Stainless Steel	3035, 3135, 4045, 4145, 4155, 4255, 4355
40AA25080	65016695 	Charge Corona Grid	3231, 3240, 3331, 3340
40AA25170	65015646 	Corona Wire 60μ 1.5μ Gold Plated Charge	3231, 3240, 3331, 3340 <i>Priced per Corona Wire, sold in Sets of 10.</i>
40AA26090	65015638 	Corona Wire 60μ 1.5μ Gold Plated Transfer, Separation	3231, 3240, 3331, 3340 <i>Priced per Corona Wire, sold in Sets of 10.</i>
N/P/N	65375230 	Corona Wire Spool Platinum alloy clad technology extends corona wire life. 80μ 7.5 m / Spool All Applications	4060, 4065, 5082, UBIX 100, UBIX 160, UBIX 160 RE, UBIX 180 RE, UBIX 180 Z, UBIX 181 ZA, UBIX 200, UBIX 200 R, UBIX 220 Z, UBIX 225 Z, UBIX 250, UBIX 280 Z, UBIX 305 R, UBIX 321 Z, UBIX 330, UBIX 400 Z, UBIX 404, UBIX 420 Z, UBIX 600 ZA, UBIX 700 ZA, UBIX 700 ZR, UBIX 760 ZA
74669000	65011002 	Corona Wire Spool 50 m / Spool 60μ Oxidized Charge	UBIX 500 Z, UBIX 550 ZA 7015

For use in
Konica
Copiers

Central/Eastern Europe
Telephone: 31(0)183-696969
Fax: 31(0)183-629055
E-mail: order@edc.katun.com

OEM PN	KATUN PN	DESCRIPTION	MODEL NO.
Corona/Charge/Transfer			
26NA25060	65019926 	Corona Wire 60μ 1.5μ Gold Plated Charge	7020, 7022, 7025, 7030, 7035, 7130, 7135, 7145, 7222, 7228, 7235 <i>Priced per Corona Wire, sold in Bags of 10.</i>
26NA26080	65020859 	Corona Wire 60μ Oxidized Discharge	7020, 7022, 7025, 7030, 7035, 7130, 7135, 7145, 7222, 7228, 7235 <i>Priced per Corona Wire, sold in Bags of 10.</i>
4400 674790	65011718 	Corona Wire 60μ Oxidized All Applications	7024 <i>Priced per Corona Wire, sold in Bags of 10.</i>
4408 631250	65019920 	Corona Wire 60μ 0.3μ Gold Plated Precleaning	7024
4408 631250	65019921 	Corona Wire 60μ 0.3μ Gold Plated Precleaning	7024 <i>Priced per Corona Wire, sold in Boxes of 10.</i>
4408 672480	65020049 	Charge Corona Grid	7024
4408 672510	65019918 	Corona Wire 60μ Oxidized All Applications	7024
4408 672510	65019919 	Corona Wire 60μ Oxidized All Applications	7024 <i>Priced per Corona Wire, sold in Sets of 10.</i>
55GA25071	65020054 	Charge Corona Grid	7033, 7040, 7045
55GA26071	65020633 	Corona Wire 60μ Oxidized Transfer, Separation	7033, 7040, 7045
55GA26071	65020634 	Corona Wire 60μ Oxidized Transfer, Separation	7033, 7040, 7045 <i>Priced per Corona Wire, sold in Bags of 10.</i>
55FA25011	65015764 	Corona Wire 60μ "Skin Pass Corona Wire"	7033, 7040, 7045, 7050, 7055, 7060, 7065, 7150 <i>Priced per Corona Wire, sold in Sets of 10.</i>



OEM PN	KATUN PN	DESCRIPTION	MODEL NO.
Corona/Charge/Transfer			
25SA25090	65013852 	Corona Wire 60μ 0.3μ Gold Plated Charge	7050 <i>Priced per Set, 10 Corona Wires per Set.</i>
25SA25081	65017260 	Charge Corona Grid	7050, 7055, 7060, 7065, 7150
25SA26120	65013105 	Corona Wire 60μ Oxidized Transfer, Separation	7050, 7055, 7060, 7065, 7150 <i>Priced per Set, 10 Corona Wires per Set.</i>
55VA25090	65019922 	Corona Wire 60μ 1.5μ Gold Plated Charge	7075
55VA25090	65019923 	Corona Wire 60μ 1.5μ Gold Plated Charge	7075 <i>Priced per Corona Wire, sold in Bags of 10.</i>
55VA25080	65021637 	Charge Corona Grid	7075, 7085
56AA25090	65023037 	Corona Wire 60μ 3.0u Gold Plated Charge	7155, 7165, 7255, 7272
56AA26090	65023038 	Corona Wire 60μ Oxidized Discharge	7155, 7165, 7255, 7272
25TU55190	65375208 	Corona Wire 60μ 0.3μ Gold Plated Pretransfer	7723, 7823, 7832 <i>Priced per Set, 10 Corona Wires per Set.</i>
N/P/N	65375229 	Corona Wire Spool Platinum alloy clad technology extends corona wire life. 70μ 7.5 m / Spool Automatic Duplex Unit Separation	UBIX 500 Z, UBIX 550 ZA

For use in
Konica
 Copiers

Central/Eastern Europe
 Telephone: 31(0)183-696969
 Fax: 31(0)183-629055
 E-mail: order@edc.katun.com

OEM PN	KATUN PN	DESCRIPTION	MODEL NO.
Developers			
00KU	65013526	Black Developer Original 600 g / Bag	1015, 1120, 1212
2296	65013527	Black Developer Original 640 g / Bag	1020
00FP	65016852	Black Developer Original 350 g / Bag	1112
003J	65017892	Black Developer Original 650 g / Bag	1216, 2223
2577	65013529	Black Developer Original 700 g / Bag	1790, UBIX 170 Z
2690	65013528	Black Developer Original 750 g / Bag Kit Contains: • (1) Black Developer	2028, 2125, 3031, 3035, 3135, 4045, 4145, 4155, 4255
00WM	65017897	Black Developer Original 650 g / Bag	3231, 3240, 3331, 3340
2777	65013530	Black Developer Original 1800 g / Bag	4060, 4065, 5082, UBIX 600 ZA, UBIX 700 ZA, UBIX 700 ZR, UBIX 760 ZA
00VP	65017197	Black Developer Original 750 g / Bag	4345, 4355
01QK	65018901	Black Developer Original 650 g / Bag	7020, 7025, 7030
000K	65018509	Black Developer Original 800 g / Bag	7033, 7040, 7045
00SH	65017249	Black Developer Original 800 g / Bag	7050, 7055, 7060, 7065, 7150
2531	65013534	Black Developer Original 430 g / Bag	UBIX 112, UBIX 112 Z
2445	65013532	Black Developer Original 650 g / Bag	UBIX 115 Z













Central/Eastern Europe
Telephone: 31(0)183-696969
Fax: 31(0)183-629055
E-mail: order@edc.katun.com

For use in
Konica
Copiers















OEM PN	KATUN PN	DESCRIPTION	MODEL NO.
Developers			
2496	65013533	Black Developer Original 650 g / Bag	UBIX 150, UBIX 150 Z
2127	65013525	Black Developer Original 1100 g / Bag	UBIX 160, UBIX 160 RE, UBIX 180 RE, UBIX 180 Z, UBIX 181 ZA, UBIX 220 Z, UBIX 250, UBIX 280 Z, UBIX 320 Z, UBIX 321 Z

For use in
Konica
Copiers

Central/Eastern Europe
Telephone: 31(0)183-696969
Fax: 31(0)183-629055
E-mail: order@edc.katun.com











OEM PN	KATUN PN	DESCRIPTION	MODEL NO.	
Feed/Delivery				
25HA41094	65013181 	Manual Paper Feed Roller Tire Only	1015, 1120, 1212, 1216, 2223	<i>Priced per Tire, sold in Bags of 10.</i>
540040562	65015378 	Paper Feed Tire Tire Only	1015, 1120, 1212, 2028, 2125, 3031, 3035, 3135, 3231, 3240, 3331, 3340, 4045, 4145, 4155, 4255, 4345, 4355, 5370, 6192, 7020, 7022, 7025, 7030, 7033, 7035, 7040, 7045, 7050, 7055, 7060, 7065, 7130, 7135, 7145, 7150, 7155, 7165, 7222, 7228, 7235, 7255, 7272, DB- 206 A, DB- 206 B, DB- 208, DB- 606, DB- 608, DF- 307 M, LT- 151, LT- 251, MT- 101, PF- 201, PF- 202	<i>Priced per Tire, sold in Bags of 10.</i>
5400-4301	65009202 	Double Feed Prevention Roller Tire Only	1020, 1120, 1212, 2028, 2125, 3031, 3035, 3135, 4045, 4145, 4155, 4255, 4345, 4355, 5370, 7050, DF- 307, LT- 251, MT- 101, PF- 202	<i>Priced per Tire, sold in Bags of 10.</i>
25BA40320	65018142 	Paper Pickup Tire Tire Only Ribbed Tire	1020, 2028, 2125, 3031, 3035, 3135, 3231, 3240, 3331, 3340, 4045, 4145, 4155, 4255, 4345, 4355, 7020, 7022, 7025, 7030, 7033, 7035, 7040, 7045, 7050, 7060, 7130, 7135, 7145, 7222, 7228, 7235, DB- 206 A, DB- 206 B, DB- 208, DB- 606, DB- 608, LT- 151, LT- 251, PF- 201, PF- 202	<i>Priced per Tire, sold in Bags of 10.</i>
25HA41351	65009202 	Double Feed Prevention Tire Tire Only	1216, 2223	<i>Priced per Tire, sold in Bags of 10.</i>
396040320	65000146 	Paper Feed Roller Tire Only	1790, 2590, 5370, 8028, UBIX 170 Z, UBIX 225 Z, UBIX 250 Z, UBIX 404, MT- 101	<i>Priced per Tire, sold in Bags of 10.</i>
396077090	65000146 	Reverse Roller Tire Only	1790, 2590, 7728, 8028, 9028, UBIX 170 Z, UBIX 225 Z, UBIX 250 Z, AD- 205, AD- 207, AD- 304	<i>Priced per Tire, sold in Bags of 10.</i>
466040910	65000146 	Paper Feed Roller Tire Only	1790, 2590, 8028, UBIX 170 Z, UBIX 250 Z	<i>Priced per Tire, sold in Bags of 10.</i>
40AA40132	65021718 	Paper Feed Guide Plate (Upper)	3231, 3240, 3331, 3340, 7033, 7040, 7045	
312041100	65012388 	Paper Feed Belt	4060, 5082, 7728, 8010, UBIX 150, UBIX 150 Z, UBIX 160, UBIX 160 RE, UBIX 180 RE, UBIX 180 Z, UBIX 181 ZA, UBIX 220 Z, UBIX 225 Z, UBIX 250, UBIX 280 Z, UBIX 320 Z, UBIX 321 Z, UBIX 400 Z, UBIX 420 Z, UBIX 500 Z, UBIX 550 ZA, UBIX 600 ZA, UBIX 700 ZA, UBIX 700 ZR, UBIX 760 ZA, AD- 301, AD- 302, AD- 303, AD- 303 A, DF- 301	



OEM PN	KATUN PN	DESCRIPTION	MODEL NO.	
Feed/Delivery				
312041100/10	65012429 	Paper Feed Belt	4060, 5082, 7728, 8010, UBIX 150, UBIX 150 Z, UBIX 160, UBIX 160 RE, UBIX 180 RE, UBIX 180 Z, UBIX 181 ZA, UBIX 220 Z, UBIX 225 Z, UBIX 250, UBIX 280 Z, UBIX 320 Z, UBIX 321 Z, UBIX 400 Z, UBIX 420 Z, UBIX 500 Z, UBIX 550 ZA, UBIX 600 ZA, UBIX 700 ZA, UBIX 700 ZR, UBIX 760 ZA, AD- 301, AD- 302, AD- 303, AD- 303 A, DF- 301	<i>Priced per Package, 10 Belts per Package.</i>
25AA40011	65016268 	Paper Feed Tire A Tire Only	5370, 6192, 7050, 7055, 7060, 7065, 7150, LT- 351, LT- 352, MT- 101, PF- 304	<i>Priced per Tire, sold in Bags of 10.</i>
26NA40110	65022793 	Double Feed Prevention Tire Upper	7020, 7022, 7025, 7030, 7035, 7130, 7135, 7145, 7222, 7228, 7235, DB- 209, DB- 409	<i>Priced per Tire, sold in Bags of 10.</i>
26NA40120	65022794 	Double Feed Prevention Tire Lower	7020, 7022, 7025, 7030, 7035, 7130, 7135, 7145, 7222, 7228, 7235, DB- 209, DB- 409	<i>Priced per Tire, sold in Bags of 10.</i>
26NA40090	65022792 	Paper Feed Tire Ribbed Tire	7020, 7022, 7025, 7030, 7035, 7130, 7135, 7145, DB- 209, DB- 409	<i>Priced per Tire, sold in Bags of 10.</i>
26NA-4280	65018142 	Bypass Pickup Roller Tire Only Ribbed Tire	7020, 7025, 7030, 7035, 7135, 7145, 7222, 7228, 7235	<i>Priced per Tire, sold in Bags of 10.</i>
4401 964280	65019949 	Separation Tire Tire Only	7024	<i>Priced per Tire, sold in Bags of 10.</i>
4401 964290	65019949 	Separation Roller Tire Only	7024	<i>Priced per Tire, sold in Bags of 10.</i>
4401 964410	65019948 	Paper Feed Roller Tire Only	7024	<i>Priced per Tire, sold in Bags of 10.</i>
4401 964420	65019948 	Paper Feed Tire Tire Only	7024	<i>Priced per Tire, sold in Bags of 10.</i>
4401 966500	65017818 	Bypass Pickup Roller Tire Only	7024	<i>Priced per Tire, sold in Bags of 10.</i>
4401 966510	65017818 	Paper Feed Tire Tire Only	7024	<i>Priced per Tire, sold in Bags of 10.</i>
4401 967330	65018878 	Paper Pickup Roller	7024	
4402 038460	65009693 	Paper Feed Roller Tire Only	7024	<i>Priced per Tire, sold in Bags of 10.</i>

For use in
Konica
Copiers

Central/Eastern Europe
Telephone: 31(0)183-696969
Fax: 31(0)183-629055
E-mail: order@edc.katun.com

OEM PN	KATUN PN	DESCRIPTION	MODEL NO.	
Feed/Delivery				
4402 038470	65009693 	Paper Feed Tire Tire Only	7024	<i>Priced per Tire, sold in Bags of 10.</i>
4402 474100	65021590 	Paper Feed Roller Kit Kit Contains: • (1) Paper Feed Tire • (1) Separation Tire • (1) Paper Pickup Roller	7024	
25SA40960	65016677 	Double Feed Prevention Tire Tire Only	7050, 7055, 7060, 7065, 7150, 7155, 7165, 7255, 7272, ColorFORCE 8050, KL 5100, LT- 351, LT- 352	<i>Priced per Tire, sold in Bags of 8.</i>
25SA-4851	65020852 	Paper Feed Tire Four Feed Rollers with Shaft Pin	7050, 7060, 7150	<i>Priced per Tire, sold in Bags of 4.</i>
55FA58190	65020760 	Torque Limiter	7055, 7060, 7065, 7150, LT- 351, LT- 352, LT- 401, LT- 402, LT- 411, LT- 412	
55VA-4830	65019940 	Feed/Double Feed Prevention Roller Assy Tire Only	7075, 7085, LT- 401, LT- 402, LT- 411, LT- 412	<i>Priced per Tire, sold in Bags of 10.</i>
55VA-4840	65019941 	Paper Feed Roller Assembly	7075, 7085, LT- 401, LT- 402, LT- 411, LT- 412	<i>Priced per Feed/Sep Roller, sold in Bags of 10.</i>
067640290	65012388 	Paper Feed Belt	UBIX 404, LT- 201, PF- 301	
067640290/10	65012429 	Paper Feed Belt	UBIX 404, LT- 201, PF- 301	<i>Priced per Package, 10 Belts per Package.</i>
4408-0751-01	65021209 	Separation Pad "Pad only"	AFR- 9, DF- 723	<i>Priced per Separation Pad, sold in Bags of 10.</i>
4408-0751-01	65023916 	Separation Pad	AFR- 9, DF- 723	
4426-3128-02	65020979 	Original Feed Roller	AFR- 9, DF- 723	<i>Priced per Feed/Sep Roller, sold in Bags of 4.</i>
4426-3128-02	65011858 	Original Feed Roller Tire Only	AFR- 9, DF- 723	<i>Priced per Tire, sold in Bags of 4.</i>
112E51220	65023398 	Paper Feed Roller Tire Only Ribbed Tire	DB- 431, DB- 432	<i>Priced per Tire, sold in Bags of 4.</i>
112E51230	65023398 	Paper Pickup Roller Tire Only Ribbed Tire	DB- 431, DB- 432	<i>Priced per Tire, sold in Bags of 4.</i>



















Katun Performance Product

© 2004 Katun Corporation

13 September 2004 For the most current product and pricing information, visit the Katun On-Line Catalog at www.katun.com.

Prices, terms and conditions are subject to change without notice.



OEM PN	KATUN PN	DESCRIPTION	MODEL NO.	
Feed/Delivery				
048040270	65019623 	Paper Feed Belt	DF- 203, DF- 204, DF- 305, DF- 308	
12ER40313	65009202 	Double Feed Prevention Roller Tire Only	DF- 306	<i>Priced per Tire, sold in Bags of 10.</i>
12ER40573	65019622 	Original Feed Belt	DF- 306	
12QV40310	65017944 	Double Feed Prevention Roller Tire Only	DF- 309	<i>Priced per Tire, sold in Bags of 10.</i>
12VR40100	65021387 	Original Feed Tire B	DF- 310	<i>Priced per Tire, sold in Bags of 10.</i>
120A45820	65021614 	Paper Pickup/Feed Roller Tire Only	DF- 311, DF- 312, DF- 315	<i>Priced per Tire, sold in Bags of 10.</i>
111V-9310	65021477 	Separation Pad "Pad only"	DF- 331	<i>Priced per Separation Pad, sold in Bags of 10.</i>
111V51150	65022790 	Paper Feed Roller	DF- 331	<i>Priced per Feed/Sep Roller, sold in Bags of 2.</i>
111V51160	65022624 	Paper Takeup Roller	DF- 331	<i>Priced per Takeup Roller, sold in Bags of 2.</i>
12EV20730	65011334 	Reverse Roller Unit Tire Only	DF- 402	<i>Priced per Tire, sold in Bags of 4.</i>
12EV20780	65011549 	Original Pickup Roller	DF- 402	<i>Priced per Roller, sold in Bags of 2.</i>
12EV23170	65014698 	Original Feed Roller Unit Ribbed Tire	DF- 402	
12EV23170	65019854 	Original Feed Roller Unit Tire Only Ribbed Tire	DF- 402	<i>Priced per Tire, sold in Bags of 9.</i>
12EV23250	65014427 	Separation Belt Gray	DF- 402	
11UP45170	65016970 	Original Pickup Roller Tire Only	DF- 724	<i>Priced per Tire, sold in Bags of 4.</i>
11UP45180	65021752 	Original Pickup Roller	DF- 724	

For use in
Konica
 Copiers















Central/Eastern Europe
 Telephone: 31(0)183-696969
 Fax: 31(0)183-629055
 E-mail: order@edc.katun.com

OEM PN	KATUN PN	DESCRIPTION	MODEL NO.
-----------	-------------	-------------	--------------

Feed/Delivery

4474-0217-04	65021495 	Separation Pad "Pad only"	DF- 724	<i>Priced per Separation Pad, sold in Bags of 10.</i>
122H48251	65022977 	Exit Roller	FS- 106, FS- 108, FS- 108 B, FS- 110, FS- 111, FS- 210, FS- 211	<i>Priced per Exit Roller, sold in Boxes of 2.</i>





















OEM PN	KATUN PN	DESCRIPTION	MODEL NO.
Filters			
490010170	65010664 	Ozone Filter Assembly	1015, 1020, 1120, 1212, 2590, 4060, 4065, 5082, UBIX 112 Z, UBIX 115 Z, UBIX 250 Z, UBIX 600 ZA, UBIX 700 ZA, UBIX 700 ZR, UBIX 760 ZA
392061801 <i>Final Inventory</i>	65010663 	Ozone Filter	1112, 1790, UBIX 112, UBIX 170 Z
540073051	65010666 	Ozone Filter 2	2028, 2125, 3031, 3035, 3135, 4045, 4145
540073071	65013832 	Toner Filter	2028, 2125, 3031, 3035, 3135, 4045, 4145, 4155, 4255, 4345, 4355, 7050, 7060, 7065, 7150
25SA62100	65016792 	Dust Proof Filter	2028, 2125, 3031, 3035, 3135, 4045, 4145, 4155, 4255, 4345, 4355, 7050, 7060, 7150
540073061	65010665 	Ozone Filter 1	2028, 2125, 3031, 3035, 4045
40AA73060 <i>Final Inventory</i>	65016863 	Suction Ozone Filter	3231, 3240, 3331, 3340
454031140 <i>Final Inventory</i>	65018160 	Filter Bag	4060, 4065, 5082, UBIX 600 ZA, UBIX 700 ZA, UBIX 700 ZR, UBIX 760 ZA
454031141 <i>Final Inventory</i>	65018160 	Filter Bag	4065, 5082
25BA73092	65015998 	Ozone Filter	4155, 4255, 4345, 4355, 7050
4408 665150	65016859 	Ozone Filter	7024
4408 665160	65016861 	Ozone Filter	7024
55FA73010	65018380 	Ozone Filter	7055, 7060, 7065, 7075, 7085, 7150, 7155, 7165
25SA-6940	65016792 	Dust Proof Filter Assembly	7060, 7150
55VA31080 <i>Final Inventory</i>	65021659 	Suction Filter	7075, 7085



For use in
Konica
Copiers

Central/Eastern Europe
Telephone: 31(0)183-696969
Fax: 31(0)183-629055
E-mail: order@edc.katun.com

OEM PN	KATUN PN	DESCRIPTION	MODEL NO.
Fuser Cleaning			
25HA53430	65011600 	Fuser Cleaning Roller Felt Type	1015
25AA53251	65014555 	Fuser Cleaning Roller	1015, 1020, 1120, 1212
26AA53251	65014555 	Fuser Cleaning Roller	1015, 1020, 1120, 1212
552053052	65009367 	Fuser Cleaning Roller FIBRA™	1020
552053052	65011600 	Fuser Cleaning Roller Felt Type	1020
392053260	65639030 	Fuser Cleaning Roller	1112, UBIX 112, UBIX 112 Z
35EA53050	65016222 	Fuser Cleaning Roller	1120, 1216, 2223
PCUA 947-218	65016222 	Fuser Cleaning Roller	1216, 2223
466053040	65632531 	Fuser Cleaning Roller	1790, 2590, 8028, UBIX 170 Z, UBIX 250 Z
25BA53393	65015489 	Web Supply Roller Kit Contains: • (1) Web Supply Roller	2028, 2125, 3031, 3035, 3135, 4045, 4145, 4155, 4255, 4345, 4355
540053201	65015489 	Cleaning Web Kit Contains: • (1) Web Supply Roller	2028, 3035, 4045
40AA-5360	65016996 	Cleaning Web	3231, 3240, 3331, 3340
40AA53120	65019706 	Fuser Cleaning Roller	3231, 3240, 3331, 3340
PCUA 947-433	65016996 	Cleaning Web	3231, 3240, 3331, 3340
318053314	65633557 	Fuser Cleaning Roller	4060, 4065, 5082, UBIX 500 Z, UBIX 550 ZA, UBIX 600 ZA, UBIX 700 ZA, UBIX 700 ZR, UBIX 760 ZA
454053261	65008790 	Oil Roller	4060, 4065, 5082, UBIX 600 ZA, UBIX 700 ZA, UBIX 700 ZR, UBIX 760 ZA
26NA53430	65019703 	Web Supply Roller	7020, 7022, 7025, 7030, 7035, 7130
26NA53830	65019702 	Fuser Cleaning Roller	7020, 7022, 7025, 7030, 7035, 7130, 7135
SR 2060 H	65015411 	Fuser Cleaning Roller	7024



OEM PN	KATUN PN	DESCRIPTION	MODEL NO.
Fuser Cleaning			
55GA53120	65016968 	Fuser Cleaning Roller	7033, 7040
55GA53501	65023251 	Fuser Roller Cleaning Pad	7033, 7040, 7045
25SA-5350	65017007 	Oil Pad	7050
25SA53211	65017527 	Oil Supply Roller	7050
25SA53200	65015652 	Upper Fuser Cleaning Roller	7050, 7055, 7060, 7065, 7150
55FA-5350	65017007 	Oil Pad	7055, 7060, 7065, 7150
55FA53130	65017527 	Oil Supply Roller	7055, 7060, 7065, 7150
55VA53860	65019598 	Lower Fuser Cleaning Roller	7075
55VA-5240	65019297 	Cleaning Web Assembly	7075, 7085
26NA53432	65019703 	Web Supply Roller	7145, 7222, 7228, 7235
25TU53200	65017937 	Fuser Cleaning Roller	7723, 7823, 7832
25TU54100	65018516 	Oil Supply Roller	7723, 7823, 7832
25TU54110	65019439 	Oil Application Roller	7723, 7823, 7832
25TU54120	65018896 	Oil Pickup Roller	7723, 7823, 7832
508053180	65011967 	Fuser Cleaning Roller	UBIX 115 Z

For use in
Konica
Copiers

Central/Eastern Europe
Telephone: 31(0)183-696969
Fax: 31(0)183-629055
E-mail: order@edc.katun.com

OEM PN	KATUN PN	DESCRIPTION	MODEL NO.
-----------	-------------	-------------	--------------

Fuser Oil

004M	65019687 	Fuser Oil 1000 ml / Bottle	7723, 7823, 7832	<i>Priced per Bottle, sold in Boxes of 6.</i>
------	---	--------------------------------------	------------------	---









Central/Eastern Europe
Telephone: 31(0)183-696969
Fax: 31(0)183-629055
E-mail: order@edc.katun.com

For use in
Konica
Copiers

OEM PN	KATUN PN	DESCRIPTION	MODEL NO.
Gears			
55FA77070	65019318 	Cleaner Idler Gear (18T)	7055, 7060, 7065, 7150

For use in
Konica
 Copiers

Central/Eastern Europe
 Telephone: 31(0)183-696969
 Fax: 31(0)183-629055
 E-mail: order@edc.katun.com

OEM PN	KATUN PN	DESCRIPTION	MODEL NO.
Kits			
00KH	65016428 	30K PM Kit Kit Contains: <ul style="list-style-type: none"> • (1) Drum Cleaning Blade • (1) Fuser Cleaning Roller • (1) Ozone Filter Assembly • (1) Cleaning Pad • (1) Cleaning Kit 	1015, 1120, 1212
2693	65016129 	50K PM Kit Kit Contains: <ul style="list-style-type: none"> • (1) Toner Collection Box • (1) Web Supply Roller • (1) Toner Filter • (1) Cleaning Pad • (1) Cleaning Kit 	2028, 3035, 4045
00TE	65016130 	60K PM Kit Kit Contains: <ul style="list-style-type: none"> • (1) Toner Collection Box • (1) Web Supply Roller • (1) Toner Filter • (1) Cleaning Pad • (1) Cleaning Kit 	2125, 3031
00NJ	65016346 	60K PM Kit Kit Contains: <ul style="list-style-type: none"> • (1) Web Supply Roller • (1) Toner Filter • (1) Toner Collection Box • (1) Cleaning Pad • (1) Cleaning Kit 	3135, 4145
01QQ	65019780 	100K Maintenance Kit Kit Contains: <ul style="list-style-type: none"> • (1) Lower Pressure Roller • (1) Upper Fuser Roller • (1) Fuser Cleaning Roller • (1) Web Supply Roller • (2) Heat Insulating Sleeve A • (1) Heat Insulating Sleeve B 	7020, 7025, 7030
PCUA 950-256	65023170 	Maintenance Kit Kit Contains: <ul style="list-style-type: none"> • (1) Lower Pressure Roller • (1) Upper Fuser Roller • (2) Heat Insulating Sleeve A • (1) Heat Insulating Sleeve B 	7022, 7130
4402 474100	65021590 	Paper Feed Roller Kit Kit Contains: <ul style="list-style-type: none"> • (1) Paper Feed Tire • (1) Separation Tire • (1) Paper Pickup Roller 	7024



For use in
Konica
Copiers







Central/Eastern Europe
Telephone: 31(0)183-696969
Fax: 31(0)183-629055
E-mail: order@edc.katun.com

OEM PN	KATUN PN	DESCRIPTION	MODEL NO.
-----------	-------------	-------------	--------------

Lamps

25JF83030	65016168 	Heater Lamp 230V 1150W	2125, 3031
454083011	65021116 	Exposure Lamp 160V 300W	4065, 5082, UBIX 700 ZA, UBIX 700 ZR, UBIX 760 ZA













OEM PN	KATUN PN	DESCRIPTION	MODEL NO.
Memory Upgrades			
19082110	65018415 	Memory Upgrade Board- 2 MB Copier Memory	7015
19082120	65018413 	Memory Upgrade Board- 4 MB Copier Memory	7015
19082130	65018414 	Memory Upgrade Board- 8 MB Copier Memory	7015
PCUA 950-218	65019995 	Memory Upgrade Board- 64 MB Printer Memory Upgrade	7020, 7025, 7030, 7035, 7045, 7155, 7165, IP- 011, IP- 421, IP- 423, IP- 431, IP- 511
PCUA 950-219	65019996 	Memory Upgrade Board-128 MB Printer Memory Upgrade	7020, 7025, 7030, 7035, 7045, 7155, 7165, IP- 421, IP- 423, IP- 511
PCUA 950-217	65019994 	Memory Upgrade Board- 32 MB Printer Memory Upgrade	7020, 7025, 7030, 7035, 7045, IP- 011, IP- 421, IP- 431
PCUA 950-808 <i>Final Inventory</i>	65017663 	Memory Upgrade Board-128 MB Controller Memory	IP- 302 +, IP- 303, IP- 402 +, IP- 411













For current memory upgrade pricing, visit our on-line catalogue at www.katun.com or contact your customer service representative.

For use in
Konica
Copiers

Central/Eastern Europe
Telephone: 31(0)183-696969
Fax: 31(0)183-629055
E-mail: order@edc.katun.com





OEM PN	KATUN PN	DESCRIPTION	MODEL NO.	
Photoreceptors				
00KL	65015758 	OPC Drum 12 Drums per Master Carton	1015, 1120, 1212, 1216, 2223	<i>Priced per Drum, sold per Drum.</i>
00KL	65013630	OPC Drum Original	1015, 1120, 1212, 1216, 2223	
2434	65502773 	OPC Drum 12 Drums per Master Carton	1020, UBIX 115 Z	<i>Priced per Drum, sold per Drum.</i>
2434	65012958	OPC Drum Access By Katun 12 Drums per Master Carton	1020, UBIX 115 Z	<i>Priced per Drum, sold per Drum.</i>
00FB	65011741 	OPC Drum 12 Drums per Master Carton	1112	<i>Priced per Drum, sold per Drum.</i>
2573	65502771 	OPC Drum 12 Drums per Master Carton	1790, 2590, UBIX 170 Z, UBIX 250 Z	<i>Priced per Drum, sold per Drum.</i>
30.418	65013479 	OPC Drum 12 Drums per Master Carton	2028, 2125, 3031, 3035, 3135, 4045, 4145, 4155, 4255	<i>Priced per Drum, sold per Drum.</i>
30.418	65014224	OPC Drum Access By Katun 12 Drums per Master Carton	2028, 2125, 3031, 3035, 3135, 4045, 4145, 4155, 4255	<i>Priced per Drum, sold per Drum.</i>
00VQ	65013479 	OPC Drum 12 Drums per Master Carton	2028, 2125, 3031, 3035, 3135, 4045, 4145, 4155, 4255, 4345, 4355	<i>Priced per Drum, sold per Drum.</i>
00VQ	65014224	OPC Drum Access By Katun 12 Drums per Master Carton	2028, 2125, 3031, 3035, 3135, 4045, 4145, 4155, 4255, 4345, 4355	<i>Priced per Drum, sold per Drum.</i>
N/P/N	65022265 	PS1 Filter Pack Kit Contains: • (10) Sensor Filter • (1) Installation Advisory	3135, 4145, 4155, 4255, 4345, 4355	
00WP	65015430 	OPC Drum 12 Drums per Master Carton	3231, 3240, 3331, 3340	<i>Priced per Drum, sold per Drum.</i>
00WP	65017899	OPC Drum Original	3231, 3240, 3331, 3340	
00AB	65011030 	As2Se3 Drum with Hardware 6 Drums per Master Carton	4060, 4065, 5082, UBIX 600 ZA, UBIX 700 ZA, UBIX 700 ZR, UBIX 760 ZA	<i>Priced per Drum, sold per Drum.</i>
00AG	65011030 	As2Se3 Drum with Hardware 6 Drums per Master Carton	4060, 4065, UBIX 600 ZA, UBIX 700 ZA, UBIX 700 ZR, UBIX 760 ZA	<i>Priced per Drum, sold per Drum.</i>















OEM PN	KATUN PN	DESCRIPTION	MODEL NO.	
Photoreceptors				
00LE	65012412 	As2Se3 Drum 6 Drums per Master Carton	5370, 5370 M, 6192	<i>Priced per Drum, sold per Drum.</i>
PCUA 950-253	65022948 	OPC Drum 12 Drums per Master Carton	7020, 7022, 7025, 7030, 7035, 7130, 7135	<i>Priced per Drum, sold per Drum.</i>
PCUA 950-253	65018900	OPC Drum Original	7020, 7022, 7025, 7030, 7035, 7130, 7135	
OD2460	65018453 	OPC Drum 12 Drums per Master Carton	7024	<i>Priced per Drum, sold per Drum.</i>
000J	65022947 	OPC Drum 12 Drums per Master Carton	7033, 7040, 7045	<i>Priced per Drum, sold per Drum.</i>
00SJ	65020898 	OPC Drum 12 Drums per Master Carton	7050	<i>Priced per Drum, sold per Drum.</i>
006J	65020898 	OPC Drum 12 Drums per Master Carton	7055, 7060, 7065, 7150	<i>Priced per Drum, sold per Drum.</i>
01SL	65019499 	OPC Drum 6 Drums per Master Carton	7075	<i>Priced per Drum, sold per Drum.</i>
PCUA 950-972	65022023 	OPC Drum 6 Drums per Master Carton	7085	<i>Priced per Drum, sold per Drum.</i>
PCUA 950-279	65023076 	OPC Drum This drum is packaged for use in Minolta, but is approved for use in these Konica models. 20 Drums per Master Carton	7115, 7118, 7216, 7220	<i>Priced per Drum, sold per Drum.</i>
PCUA 960-422	65023199 	OPC Drum 12 Drums per Master Carton	7145	<i>Priced per Drum, sold per Drum.</i>
PCUA 950-566	65021677 	OPC Drum 12 Drums per Master Carton	7155, 7165, 7255, 7272	<i>Priced per Drum, sold per Drum.</i>
N/P/N	65023543 	Drum Cartridge Rebuild Kit Kit Contains: • (1) OPC Drum • (1) Drum Cleaning Blade • (1) Black Toner • (1) Disposable Funnel 1 OPC Kit per Master Carton	7415, 7415 FAX	<i>Priced per OPC Kit, sold per OPC Kit.</i>

For use in
Konica
 Copiers

Central/Eastern Europe
 Telephone: 31(0)183-696969
 Fax: 31(0)183-629055
 E-mail: order@edc.katun.com

















OEM PN	KATUN PN	DESCRIPTION	MODEL NO.	
Photoreceptors				
004A	65022274 	OPC Drum 6 Drums per Master Carton	7723, 7823	<i>Priced per Drum, sold per Drum.</i>
1179-0297-01	65022274 	OPC Drum 6 Drums per Master Carton	7832	<i>Priced per Drum, sold per Drum.</i>
2501	65502770 	OPC Drum 12 Drums per Master Carton	UBIX 112, UBIX 112 Z	<i>Priced per Drum, sold per Drum.</i>
2117	65502709 	SeTe Drum with Hardware 6 Drums per Master Carton	UBIX 160, UBIX 160 RE, UBIX 180 RE, UBIX 180 Z, UBIX 181 ZA, UBIX 220 Z, UBIX 225 Z, UBIX 250, UBIX 280 Z, UBIX 320 Z, UBIX 321 Z	<i>Priced per Drum, sold per Drum.</i>
2189	65507348 	As2Se3 Drum with Hardware 6 Drums per Master Carton	UBIX 400 Z, UBIX 404, UBIX 420 Z	<i>Priced per Drum, sold per Drum.</i>



















OEM PN	KATUN PN	DESCRIPTION	MODEL NO.	
Picker Fingers				
508053202	65012974 	Upper Picker Finger	1020, UBIX 115 Z	<i>Priced per Set, 6 Picker Fingers per Set.</i>
26AA53062	65020605 	Picker Finger	1120, 1216, 2223, 7020, 7025, 7030, 7035	<i>Priced per Picker Finger, sold in Boxes of 6.</i>
300053120	65013023 	Upper Picker Finger	1790, 2590, 7728, 8010, 8028, 9028, UBIX 150, UBIX 150 Z, UBIX 160, UBIX 160 RE, UBIX 170 Z, UBIX 180 RE, UBIX 180 Z, UBIX 181 ZA, UBIX 220 Z, UBIX 225 Z, UBIX 250, UBIX 250 Z, UBIX 280 Z, UBIX 320 Z, UBIX 321 Z	<i>Priced per Picker Finger, sold in Packages of 6.</i>
25BA53320	65013113 	Upper Picker Finger	2028, 2125, 3031, 3035, 3135, 3231, 3240, 3331, 3340, 4045, 4145, 4155, 4255, 4345, 4355	<i>Priced per Set, 6 Picker Fingers per Set.</i>
540053100	65012975 	Lower Picker Finger	2028, 2125, 3031, 3035, 3135, 3231, 3240, 3331, 3340, 4045, 4145, 7033, 7040, 7045	<i>Priced per Set, 3 Picker Fingers per Set.</i>
25BA53330	65014856 	Lower Picker Finger	4155, 4255, 4345, 4355, 7050, 7055, 7060, 7065, 7150, 7155, 7165	<i>Priced per Set, 3 Picker Fingers per Set.</i>
25AA53160 <i>Final Inventory</i>	65013477 	Upper Picker Finger	5370, 5370 M, 6192	<i>Priced per Set, 10 Picker Fingers per Set.</i>
26NA54270	65020605 	Picker Finger	7020, 7022, 7025, 7030, 7035, 7130, 7135, 7145	<i>Priced per Picker Finger, sold in Boxes of 6.</i>
4401 952060	65016679 	Upper Picker Finger	7024	<i>Priced per Picker Finger, sold in Packages of 6.</i>
4408 631300	65017587 	Drum Picker Finger	7024	<i>Priced per Picker Finger, sold in Boxes of 6.</i>
25SA53151	65013478 	Upper Picker Finger	7033, 7040, 7045, 7050, 7055, 7060, 7065, 7150	<i>Priced per Set, 6 Picker Fingers per Set.</i>
55VA29190	65019648 	Drum Picker Finger	7075, 7085	<i>Priced per Picker Finger, sold in Bags of 3.</i>

For use in
Konica
Copiers



Central/Eastern Europe
Telephone: 31(0)183-696969
Fax: 31(0)183-629055
E-mail: order@edc.katun.com

OEM PN	KATUN PN	DESCRIPTION	MODEL NO.
Rollers, Fuser/Heat			
25HA53081	65016348 	Upper Fuser Roller TRITON™ II	1015, 1212
508053150	65015211 	Upper Fuser Roller TRITON™ II	1020, UBIX 115 Z
508053150	65014843	Upper Fuser Roller Access By Katun	1020, UBIX 115 Z
585053070	65015210 	Upper Fuser Roller TRITON™ II	1112
26AA53053	65013830 	Upper Fuser Roller TRITON™ II	1120, 1216, 2223
466053010	65012733 	Upper Fuser Roller TRITON™ II	1790, UBIX 170 Z
576053010	65012734 	Upper Fuser Roller TRITON™ II	2028, 2125
492053140	65012735 	Upper Fuser Roller TRITON™ II	2590, 8028, UBIX 250 Z
540053010	65012737 	Upper Fuser Roller TRITON™ II	3031, 3035, 3135
540053010	65014845	Upper Fuser Roller Access By Katun	3031, 3035, 3135
N/P/N	65012744 	Upper Fuser Roller Assembly TRITON™ II Includes: • (2) Ball Bearing • (2) Heat Insulating Sleeve	3031, 3035, 3135
35FA53031	65016632 	Upper Fuser Roller OEM Type	3231, 3331
40AA53031	65015642 	Upper Fuser Roller OEM Type	3240, 3340
544053010	65012740 	Upper Fuser Roller TRITON™ II	4045, 4145
544053010	65014846	Upper Fuser Roller Access By Katun	4045, 4145
496053051 <i>Final Inventory</i>	65012741 	Upper Fuser Roller TRITON™ II	4060, UBIX 600 ZA
454053052 <i>Final Inventory</i>	65636790 	Upper Fuser Roller 30µ PFA Sleeve OEM Type	4065, 5082, UBIX 700 ZA, UBIX 700 ZR, UBIX 760 ZA
454053052 <i>Final Inventory</i>	65012741 	Upper Fuser Roller TRITON™ II	4065, 5082, UBIX 700 ZA, UBIX 700 ZR, UBIX 760 ZA
25BA53162	65012467 	Upper Fuser Roller TRITON™ II	4155, 4255, 4355





















OEM PN	KATUN PN	DESCRIPTION	MODEL NO.
Rollers, Fuser/Heat			
45EA53011	65012740 	Upper Fuser Roller TRITON™ II	4345
45EA53011	65014846	Upper Fuser Roller Access By Katun	4345
35993211	65018865 	Upper Fuser Roller	7015
26NA53034	65018883 	Upper Fuser Roller TRITON™ II	7020, 7022, 7025, 7030, 7130
26NA53030	65018883 	Upper Fuser Roller TRITON™ II	7020, 7025, 7030
26NA53031	65018883 	Upper Fuser Roller TRITON™ II	7020, 7025, 7030
HR 2060 U	65015656 	Upper Fuser Roller TRITON™ II Improved Toner Release Characteristics	7024
55GA53031	65017001 	Upper Fuser Roller TRITON™ II	7033, 7040, 7045
26TA53030	65020965 	Upper Fuser Roller TRITON™ II	7035
55FA53193	65014808 	Upper Fuser Roller TRITON™ II	7050, 7055, 7060, 7065, 7150
25SA53071	65014808 	Upper Fuser Roller TRITON™ II	7050, 7150
55VA53041	65021654 	Upper Fuser Roller	7075
56GB53040	65021654 	Upper Fuser Roller	7085
27AE53020	65022820 	Upper Fuser Roller	7115, 7115 F, 7118, 7118 F
26YF53030	65020965 	Upper Fuser Roller TRITON™ II	7135
56AE53052	65022842 	Upper Fuser Roller	7155, 7165, 7255, 7272
11YA53030	65022872 	Upper Fuser Roller	7415, 7415 FAX
25TU53010	65021504 	Upper Fuser Roller Silicone Based	7723, 7823
490053050	65015210 	Upper Fuser Roller TRITON™ II	UBIX 112, UBIX 112 Z
370054001	65012733 	Upper Fuser Roller TRITON™ II	UBIX 220 Z

For use in
Konica
Copiers

Central/Eastern Europe
Telephone: 31(0)183-696969
Fax: 31(0)183-629055
E-mail: order@edc.katun.com











OEM PN	KATUN PN	DESCRIPTION	MODEL NO.
Rollers, Fuser/Heat			
396053081	65012735 	Upper Fuser Roller TRITON™ II	UBIX 225 Z
450053082	65012738 	Upper Fuser Roller TRITON™ II	UBIX 320 Z, UBIX 321 Z
326253210	65636372 	Upper Fuser Roller OEM Type	UBIX 400 Z, UBIX 404, UBIX 420 Z



OEM PN	KATUN PN	DESCRIPTION	MODEL NO.
Rollers, Pressure			
552053032	65020952 	Lower Pressure Roller MICROSLEEVE™	1015, 1020, 1120, 1212
490053100	65636748 	Lower Pressure Roller	1112, UBIX 112 Z
35EA53040	65020961 	Lower Pressure Roller MICROSLEEVE™	1216, 2223
466053180	65020963 	Lower Pressure Roller MICROSLEEVE™ 50µ PFA Sleeve	1790, UBIX 170 Z
540053660	65636794 	Lower Pressure Roller MICROSLEEVE™	2028, 3035
25JA53662	65021559 	Lower Pressure Roller MICROSLEEVE™	2125, 3031, 3135
492053150	65636794 	Lower Pressure Roller MICROSLEEVE™	2590, 8028, UBIX 250 Z
40AA53040	65016044 	Lower Pressure Roller MICROSLEEVE™	3231, 3240, 3331, 3340
544053020	65020951 	Lower Pressure Roller MICROSLEEVE™	4045
25LA53020	65021560 	Lower Pressure Roller MICROSLEEVE™	4145
25BA53060	65020953 	Lower Pressure Roller MICROSLEEVE™	4155, 4255
45AA53440	65020953 	Lower Pressure Roller MICROSLEEVE™	4345, 4355
25AA53060 <i>Final Inventory</i>	65016067 	Lower Pressure Roller MICROSLEEVE™	5370, 5370 M, 6192
25AA53061 <i>Final Inventory</i>	65016067 	Lower Pressure Roller MICROSLEEVE™	5370, 5370 M, 6192
26NA53040	65018827 	Lower Pressure Roller	7020, 7022, 7025, 7030, 7130
HR 2060 L	65018879 	Lower Pressure Roller MICROSLEEVE™	7024
55GA53042	65021564 	Lower Pressure Roller MICROSLEEVE™	7033, 7040, 7045
26TA53040	65021440 	Lower Pressure Roller	7035, 7135, 7145
55FA53200	65020960 	Lower Pressure Roller MICROSLEEVE™	7050, 7055, 7060, 7065, 7150
25SA53720	65020953 	Lower Pressure Roller MICROSLEEVE™	7050, 7150

For use in
Konica
Copiers

Central/Eastern Europe
Telephone: 31(0)183-696969
Fax: 31(0)183-629055
E-mail: order@edc.katun.com

OEM PN	KATUN PN	DESCRIPTION	MODEL NO.
Rollers, Pressure			
55VA-5281	65020932 	Lower Pressure Roller Assembly	7075
27AE53030	65022045 	Lower Pressure Roller MICROSLEEVE™	7115, 7115 F, 7118, 7118 F
56AA53061	65022871 	Lower Pressure Roller MICROSLEEVE™	7155, 7165, 7255, 7272
11YA53020	65022053 	Lower Pressure Roller MICROSLEEVE™	7415, 7415 FAX
25TU53440	65021505 	Lower Pressure Roller Silicone Based	7723, 7823
504053040	65636794 	Lower Pressure Roller MICROSLEEVE™	7728, 9028
304054840	65020963 	Lower Pressure Roller MICROSLEEVE™ 50µ PFA Sleeve	8010, UBIX 150, UBIX 150 Z
392053100	65636748 	Lower Pressure Roller	UBIX 112
508053141	65020952 	Lower Pressure Roller MICROSLEEVE™	UBIX 115 Z
450053091	65636794 	Lower Pressure Roller MICROSLEEVE™	UBIX 225 Z, UBIX 320 Z, UBIX 321 Z
460053321 <i>Final Inventory</i>	65636882 	Lower Pressure Roller MICROSLEEVE™	UBIX 404









Central/Eastern Europe
Telephone: 31(0)183-696969
Fax: 31(0)183-629055
E-mail: order@edc.katun.com







For use in
Konica
Copiers

OEM PN	KATUN PN	DESCRIPTION	MODEL NO.
Thermal Control Devices			
25SA88420	65021691 	Upper Thermoswitch	3231, 3240, 3331, 3340, 7050, 7055, 7060, 7065, 7075, 7150, ColorFORCE 8050, KL 5100

For use in
Konica
Copiers

Central/Eastern Europe
Telephone: 31(0)183-696969
Fax: 31(0)183-629055
E-mail: order@edc.katun.com





OEM PN	KATUN PN	DESCRIPTION	MODEL NO.
Toners/Toner Cartridges			
00KW	65018893 	Black Toner 250 g / Cartridge 5 Boxes (25 Cartridges) per Master Carton	1015, 1120, 1212 <i>Priced per Cartridge, sold in Boxes of 5.</i>
00KW	65013504	Black Toner Original 209 g / Cartridge	1015, 1120, 1212
2295	65013514	Black Toner Original 125 g / Cartridge	1020
00FR	65013394	Black Toner Original 102 g / Cartridge	1112
01HL	65018893 	Black Toner 250 g / Cartridge 5 Boxes (25 Cartridges) per Master Carton	1216 <i>Priced per Cartridge, sold in Boxes of 5.</i>
01HL	65018511	Black Toner Original 250 g / Cartridge	1216
2576	65013512	Black Toner Original 250 g / Cartridge	1790, 2590, UBIX 170 Z, UBIX 250 Z
2688	65011965 	Black Toner 440 g / Cartridge 4 Boxes (16 Cartridges) per Master Carton	2028, 3035, 4045 <i>Priced per Cartridge, sold in Boxes of 4.</i>
2688	65013515	Black Toner Original 440 g / Cartridge	2028, 3035, 4045 <i>Priced per Cartridge, sold in Boxes of 4.</i>
00NM	65012320 	Black Toner 435 g / Cartridge 4 Boxes (16 Cartridges) per Master Carton	2125, 3031, 3135, 4145, 4155, 4255 <i>Priced per Cartridge, sold in Boxes of 4.</i>
00NM	65013510	Black Toner Original 430 g / Cartridge	2125, 3031, 3135, 4145, 4155, 4255 <i>Priced per Cartridge, sold in Boxes of 4.</i>
003K	65018893 	Black Toner 250 g / Cartridge 5 Boxes (25 Cartridges) per Master Carton	2223 <i>Priced per Cartridge, sold in Boxes of 5.</i>
003K	65017891	Black Toner Original 250 g / Cartridge	2223
00WW	65016408 	Black Toner 500 g / Cartridge 4 Boxes (20 Cartridges) per Master Carton	3231, 3331 <i>Priced per Cartridge, sold in Boxes of 5.</i>
00WW	65017893	Black Toner Original 500 g / Cartridge	3231, 3331

OEM PN	KATUN PN	DESCRIPTION	MODEL NO.	
Toners/Toner Cartridges				
00WN	65016408 	Black Toner 500 g / Cartridge 4 Boxes (20 Cartridges) per Master Carton	3240, 3340	<i>Priced per Cartridge, sold in Boxes of 5.</i>
00WN	65020895	Black Toner Original 500 g / Cartridge	3240, 3340	
00AK	65013513	Black Toner Original 1000 g / Cartridge	4060, 4065, 5082, UBIX 600 ZA, UBIX 700 ZA, UBIX 700 ZR, UBIX 760 ZA	<i>Priced per Cartridge, sold in Boxes of 6.</i>
00VN	65015529 	Black Toner 480 g / Cartridge 4 Boxes (16 Cartridges) per Master Carton	4345, 4355	<i>Priced per Cartridge, sold in Boxes of 4.</i>
00VN	65017180	Black Toner Original 480 g / Cartridge	4345, 4355	
001G	65014668	Black Toner Original 900 g / Cartridge	5370, 5370 M, 6192	
01QJ	65022054 	Black Toner 676 g / Cartridge 15 Cartridges per Master Carton	7020, 7025, 7030	<i>Priced per Cartridge, sold per Cartridge.</i>
01QJ	65019088	Black Toner Original 676 g / Cartridge	7020, 7025, 7030	
000X	65017511 	Black Toner 600 g / Cartridge 1 Box (4 Cartridges) per Master Carton	7033	<i>Priced per Cartridge, sold in Boxes of 4.</i>
000X	65017900	Black Toner Original 600 g / Cartridge	7033	
000W	65017511 	Black Toner 600 g / Cartridge 1 Box (4 Cartridges) per Master Carton	7040, 7045	<i>Priced per Cartridge, sold in Boxes of 4.</i>
000W	65018508	Black Toner Original 600 g / Cartridge	7040, 7045	
00SG	65017341 	Black Toner 720 g / Cartridge 3 Boxes (12 Cartridges) per Master Carton	7050	<i>Priced per Cartridge, sold in Boxes of 4.</i>
00SG	65014671	Black Toner Original 800 g / Cartridge	7050	
01RG	65019338 	Black Toner 900 g / Cartridge 10 Cartridges per Master Carton	7055, 7065	<i>Priced per Cartridge, sold per Cartridge.</i>



For use in
Konica
Copiers



Central/Eastern Europe
Telephone: 31(0)183-696969
Fax: 31(0)183-629055
E-mail: order@edc.katun.com

OEM PN	KATUN PN	DESCRIPTION	MODEL NO.
Toners/Toner Cartridges			
006G	65017341 	Black Toner 720 g / Cartridge 3 Boxes (12 Cartridges) per Master Carton	7060 <i>Priced per Cartridge, sold in Boxes of 4.</i>
01GA	65017341 	Black Toner 720 g / Cartridge 3 Boxes (12 Cartridges) per Master Carton	7060, 7150 <i>Priced per Cartridge, sold in Boxes of 4.</i>
01SJ	65018895 	Black Toner 1300 g / Cartridge 8 Cartridges per Master Carton	7075 <i>Priced per Cartridge, sold per Cartridge.</i>
PCUA 950-638	65018895 	Black Toner 1300 g / Cartridge 8 Cartridges per Master Carton	7075 <i>Priced per Cartridge, sold per Cartridge.</i>
2511	65013506	Black Toner Original 125 g / Cartridge	UBIX 112
2415	65013505	Black Toner Original 125 g / Cartridge	UBIX 112 Z, UBIX 115 Z
2491	65013507	Black Toner Original 140 g / Cartridge	UBIX 150, UBIX 150 Z <i>Priced per Box, 2 Cartridges per Box.</i>
001A	65013624	Black Toner Original 200 g / Cartridge	UBIX 160, UBIX 160 RE, UBIX 180 RE, UBIX 180 Z, UBIX 181 ZA, UBIX 220 Z, UBIX 250, UBIX 280 Z, UBIX 320 Z, UBIX 321 Z
030A	65013503	Black Toner Original 550 g / Cartridge	UBIX 500 Z, UBIX 550 ZA



Central/Eastern Europe
Telephone: 31(0)183-696969
Fax: 31(0)183-629055
E-mail: order@edc.katun.com

For use in
Konica
Copiers

OEM PN	KATUN PN	DESCRIPTION	MODEL NO.
Waste Toner Containers			
540022011	65015253 	Toner Collection Box	2028, 2125, 3031, 3035, 4045
25JA-2201	65015329 	Toner Collection Box	3135, 4145

General Information

Credit Terms and Ordering Information

Credit Terms

Standard credit terms are net-30-days from date of invoice. To open a net-30-day account, please contact the Katun Credit Department. Until your credit application is approved, orders will be shipped upon receipt of cash in advance or a confirmed, Sight Draft, or via C.O.D. (Nominal C.O.D. handling charges will apply.)

Katun offers a 3% cash-with-order (CWO) discount. Katun will calculate the 3% discount, promptly inform you of the total charges, and ship your order immediately upon receipt of your payment.

Place all orders with Katun (E.D.C.) B.V. via:

- **Telephone: 31(0) 183–696969**
- **Fax: 31(0) 183–629055**
- **E-mail: order@edc.katun.com**
- **Address:**

Katun (E.D.C.) B.V.
Edisonweg 44
4207 HG Gorinchem
The Netherlands

Reference Katun part numbers on all orders.

Prices are in Euro, EX WORKS Gorinchem, The Netherlands.

Katun business hours are from 8:30 to 17.00 hours.

Katun has a € 350 minimum order. A € 35 charge will be added to orders under the minimum.

Wire transfer funds to:

ABN–AMRO Bank
Daalsesingel 71
Postbus 2059
3500 GB Utrecht
The Netherlands
Account Number: 55 70 74 134
Swift I.D.: ABN ANL 2A
IBAN: NL51ABNA0557074134

General Shipping Information and Product Return Policies

Shipping and Handling

Katun can provide you with alternatives for shipping. We will attempt to select the most convenient and cost-effective carrier for you. However, if you have a preferred carrier, please inform your Katun Customer Service Representative.



Central/Eastern Europe

Telephone: 31(0)183-696969

Fax: 31(0)183-629055

E-mail: order@edc.katun.com

Hazardous material shipments will be billed accordingly. A nominal handling charge is incorporated into our shipping costs.

Product Return Policies

- Katun **must** preauthorize all returns. For return procedures and a return, contact the Customer Service Department at 31(0) 183–696969.
- Toner, toner cartridges, digital duplicator inks and masters, and thermal transfer ribbons with personalized labels cannot be returned to Katun for credit unless a valid warranty claim exists.
- Returns and refused shipments are subject to a minimum 10% restocking charge.
- With the exception of warranty claims, merchandise returned more than 90 days from the invoice date will not be accepted.
- Merchandise which has been written on, marked, relabeled, or placed in other than original Katun packaging will not be accepted.
- All warranty claims submitted to Katun *must* be accompanied by a completed Distributor Choice Warranty Claim Form (included in this catalog). Customers must indicate a warranty choice on the form:
 - (a) Technical Evaluation/ Replacement or technical Evaluation/ Credit: Ship the product and the completed form to:
Katun (E.D.C.) B.V.
Edisonweg 44
4207 HG
Gorinchem
The Netherlands
 - (b) Automatic Replacement: send the completed form to your customer service representative.



Allgemeine Hinweise

Zahlungsbedingungen und Bestellinformationen

Die übliche Zahlungsweise ist bar innerhalb von 30 Tagen ab Rechnungsdatum. Zur Eröffnung eines Kontos wenden Sie sich bitte an die Katun Kreditabteilung. Bis zur Gewährung Ihres Kredits erfolgt der Versand von Bestellungen bei Vorkasse oder bei Erhalt eines bestätigten, Sichtwechsel oder gegen Nachnahme (unter Berechnung einer geringen Nachnahmegebühr).

Katun gewährt 3 % Skonto für Barzahlung bei Bestellung. Katun wird den Skontobetrag errechnen, Ihnen den Gesamtbetrag mitteilen und Ihre Bestellung unverzüglich nach Erhalt Ihrer Zahlung zum Versand aufgeben.

Bitte richten Sie alle Bestellungen an Katun (E.D.C.) B.V. unter:

- **Telefon: 31 (0) 183–696969**
- **Fax: 31 (0) 183–629055**
- **E-mail: order@edc.katun.com**
- **Adresse:**

Katun (E.D.C.) B.V.
Edisonweg 44
NL-4207 HG Gorinchem
Niederlande

Bitte bei allen Bestellungen die Katun Artikelnummern angeben. Preise verstehen sich in Euro, ab Werk Gorinchem, Niederlande.

Katun Geschäftszeit ist 8.30 - 17.00 Uhr. Für alle Bestellungen gilt ein Mindestbestellwert von € 350. Bei Bestellungen unter dem Mindestbestellwert wird ein Zuschlag von €35 berechnet.

Bankverbindung:

ABN AMRO Bank
Daalsesingel 71
Postbus 2059
NL-3500 GB Utrecht
Niederlande
Kontonummer: 55 70 74 134
Bankleitzahl: ABN ANL 2A
IBAN: NL51ABNA0557074134

Versand und Warenrücksendung

Bearbeitung und Versand

Katun bietet verschiedene Versandmethoden an. Wir bemühen uns, die für Sie günstigste und praktischste Versandart zu wählen. Falls Sie eine bestimmte Versandart/Firma vorziehen, teilen Sie dies bitte Ihrem Katun Repräsentanten mit.



Central/Eastern Europe

Telephone: 31(0)183-696969

Fax: 31(0)183-629055

E-mail: order@edc.katun.com

Versandkosten für Gefahrgüter werden entsprechend berechnet. Eine geringe Bearbeitungsgebühr ist in unseren Versandgebühren enthalten.

Warenrücksendung

- Nur von Katun vorher genehmigte Waren- rücksendungen könnenbearbeitet werden. Bitte lassen Sie sich vom Kundendienst unter der Telefonnummer 31 (0) 183-696969 genaue Anweisungen geben.
- Bei Warenrücksendungen werden 10 % Rücknahmegebühren in Abzug gebracht.
- Toner, Drucker-/Faxkartuschen, Tinten für digitale Duplikatoren sowie Thermo-Transfer-Bänder mit Firmenetiketten sind vom Umtausch ausgeschlossen, es sei denn, es liegt ein Garantiefall for.
- Ware, die nach Ablauf von 90 Tagen ab Rechnungsdatum zurückgeschickt wird, kann nicht zurückgenommen werden (mit Ausnahme von Reklamationen).
- Ware, deren Verpackung markiert, etikettiert oder beschriftet wurde, oder Ware ohne Originalverpackung kann nicht zurückgenommen werden.
- Alle Garantieansprüche müssen von einem ausgefüllten Händler -Garantieformular begleitet sein (Formular in diesem Katalog enthaltrn). Geben Sie Ihren Regulierungswunsch auf dem Formular an:
 - (a) Technische Bewertung/Ersatz oder Technische Bewertung/Gutschrift: schicken Sie das Produkt und das vollständig ausgefüllte Formular an:
Katun (E.D.C.) B.V.
Edisonweg 44
NL-4207 HG Gorinchem
Niederlande
 - (b) Ersatz ohne Bewertung: schicken Sie das vollständig ausgefüllte Formular an Ihren Ansprechpartner der Auftragsbearbeitung.

DISTRIBUTOR CHOICE WARRANTY CLAIM FORM

Please print all information. For prompt processing of your claim, please complete all sections. Your feedback is important to the ongoing improvement of Katun products. Thank you.

I. WARRANTY CHOICE

Please check one. See Section 2 on reverse side for additional information.

Technical Evaluation/Replacement Technical Evaluation/Credit Automatic Replacement

II. CUSTOMER INFORMATION

Customer Number: _____ Date Shipped: _____

Company Name: _____ Delivery Date: _____

Address: _____

City: _____ State/Province: _____

Country: _____ Postal Code: _____

Your Name: _____ Title: _____

III. PRODUCT INFORMATION

	Katun PN	Quantity	Description	Serial/Lot Number
1)	_____	_____	_____	_____
2)	_____	_____	_____	_____
3)	_____	_____	_____	_____
4)	_____	_____	_____	_____
5)	_____	_____	_____	_____

IV. DETAILED REASON(S) FOR CLAIM

Provide specific information for each product claimed, explaining the reason for claim in as much detail as possible. Include machine models, machine log information, and copy/print counts. **See Section 3 on reverse side for additional specific requirements for photoreceptors.**

1) _____

2) _____

3) _____

4) _____

5) _____

FOR KATUN USE ONLY

Product Warranty Claim No.: _____

Pieces: _____

Received By: _____

Date: _____

Central/Eastern Europe

Telephone: 31(0)183-696969

Fax: 31(0)183-629055

E-mail: order@edc.katun.com

PLEASE READ AND COMPLY WITH ALL THESE REQUIREMENTS TO EXPEDITE THE PROCESSING OF YOUR CLAIM.

1. General Instructions

A completed copy of this form must accompany all product warranty claims. Please indicate date of product delivery for determination of warranty coverage time period. *Your feedback is important to the ongoing improvement of Katun products. Please complete all sections on the reverse side.*

2. Distributor Choice Warranty Claim Options

Please indicate your choice of Technical Evaluation/Replacement, Technical Evaluation/Credit, or Automatic Replacement. **NOTE:** Automatic Replacement claims must be filed within 90 days of product delivery date, and must not exceed US\$500/€ 550.

If no choice is indicated:

- (a) If product is included with this form, this claim will be treated as Technical Evaluation/Replacement.
- (b) If no product is included with this form, and the claim is less than US\$500/€ 550, this claim will be treated as Automatic Replacement.
- (c) If no product is included with this form, and the claim is more than US\$500/€ 550, the claim is invalid.

3. Specific Requirements

If damage (for example, a chip or scratch on a photoreceptor) is noted "out-of-box," **DO NOT INSTALL THE PRODUCT.** No copy/print samples are required. Installing a product with out-of-box damage could void the warranty.

Include applicable copy/print samples with all claims. If a photoreceptor is suspected to be defective after machine installation, please attach to this form the copy/print samples indicated below. This will allow a thorough evaluation of the claim. Ensure that neither the form nor copy/print samples will contact the photoreceptor surface during shipment.

FOR PHOTORECEPTORS USED IN COPIERS, include:

- (a) Three "sky shot" (open platen; black) copies;
- (b) Three white copies; and
- (c) Three copies of a test pattern.

NOTE: If the defect is not visible on the copies indicated above, please attach three copies which clearly show the defect.

FOR PHOTORECEPTORS USED IN PRINTERS AND PLAIN PAPER FACSIMILES, include three prints which clearly show the defect.

IMPORTANT: The Katun product warranty does not cover damage by operator, technician, or machine (including rotational scratches, gouges, scuff marks, or line scratches).

4. Shipping Instructions

ALL PRODUCT RETURNS MUST BE PROPERLY PACKAGED. This includes packaging in the correct individual product box and in a second container with adequate protective packaging material. This is required by all carriers.

NOTE: Products damaged in transit to Katun due to inadequate packaging cannot be covered by the Katun product warranty, and will be returned.

Ship Technical Evaluation claims, freight prepaid, to the address specifically indicated for this purpose in the "General Information" section of the Katun On-Line Catalogue and current printed catalogues. Katun cannot accept responsibility for product warranty claims sent to any other address. **Send Automatic Replacement Claims to your Katun Customer Service Representative.**

HÄNDLER-GARANTIEFORMULAR

Das Formular bitte in Druckschrift ausfüllen. Um eine umgehende Bearbeitung Ihrer Reklamation zu ermöglichen, tragen Sie bitte alle Angaben ein.

Ihr Feedback trägt zur weiteren Verbesserung von Katun-Produkten bei. Vielen Dank.

I. REGULIERUNGSWUNSCH

Bitte nur einen ankreuzen. Weitere Informationen finden Sie in Abschnitt 2 auf der Rückseite.

Technische Bewertung/Ersatz Technische Bewertung/Gutschrift Ersatz ohne Bewertung

II. KUNDENINFORMATIONEN

Kunden-Nr.: _____ Versanddatum: _____

Firmenname: _____ Lieferdatum: _____

Straße: _____

Postleitzahl: _____ Ort: _____

Land: _____

Ihr Name: _____ Titel/Funktion: _____

III. PRODUKTINFORMATIONEN

Katun-Artikel-Nr.	Menge	Bezeichnung	Serien-/Lotnummer
1) _____	_____	_____	_____
2) _____	_____	_____	_____
3) _____	_____	_____	_____
4) _____	_____	_____	_____
5) _____	_____	_____	_____

IV. AUS WELCHEM GRUND REKLAMIEREN SIE DIE WARE?

Machen Sie bitte zu jedem reklamierten Artikel so ausführliche und genaue Angaben wie möglich. Des weiteren benötigen wir Angaben zum Gerätemodell, eine Kopie des Bordbuches sowie Informationen bezüglich der Anzahl der erstellten Kopien/Ausdrucke des Produktes. **Bitte beachten Sie Punkt 3 auf der Rückseite mit wichtigen Informationen zur Reklamation von Fotorezeptoren.**

1) _____

2) _____

3) _____

4) _____

5) _____

NUR FÜR DEN INTERNEN GEBRAUCH

Reklamations-Nr.: _____ Stückzahl: _____

Entgegengenommen von: _____ Eingangsdatum: _____



Central/Eastern Europe

Telephone: 31(0)183-696969

Fax: 31(0)183-629055

E-mail: order@edc.katun.com

BITTE BEACHTEN SIE FOLGENDE HINWEISE, UM DIE BEARBEITUNG IHRER REKLAMATION ZU BESCHLEUNIGEN.

1. Allgemeine Hinweise

Verwenden Sie diesen Mängelbericht bei allen Reklamationen. Geben Sie zur Bestimmung der Garantiefrist bitte das Lieferdatum des Produktes an. *Ihr Feedback trägt zur weiteren Verbesserung von Katun-Produkten bei. Bitte tragen Sie alle Angaben auf der Rückseite vollständig ein.*

2. Händler-Garantieoption

Geben Sie bitte Ihren Regulierungswunsch an (Technische Bewertung/Ersatz, Technische Bewertung/Gutschrift oder Ersatz ohne Bewertung.) **BITTE BEACHTEN:** Reklamationen ohne Bewertung müssen innerhalb von 90 Tagen nach dem Lieferdatum des Produktes geltend gemacht werden und dürfen einen Wert von USD 500/Euro 550 nicht überschreiten.

Wenn keine Wahl getroffen wurde:

- (a) Wenn diesem Formular das Produkt beigelegt wurde, wird diese Reklamation als Technische Bewertung/Ersatz bearbeitet.
- (b) Wenn diesem Formular kein Produkt beigelegt wurde und der Wert der Reklamation weniger als USD 500/ Euro 550 beträgt, wird diese Reklamation als Ersatz ohne Bewertung bearbeitet.
- (c) Wenn diesem Formular kein Produkt beigelegt wurde und der Wert der Reklamation mehr als USD 500/ Euro 550 beträgt, besteht kein Anspruch auf Reklamation.

3. Spezielle Anforderungen

Wenn Schäden (z.B. Splitter oder Kratzer an einem Fotorezeptor) bereits „beim Auspacken“ festgestellt werden, dann **INSTALLIEREN SIE DAS PRODUKT NICHT.** Testkopien sind nicht erforderlich. Die Installation eines Produktes mit bereits bestehendem Schaden könnte zum Erlöschen Ihrer Garantieansprüche führen.

Fügen Sie allen Reklamationen entsprechende Testkopien bei. Wenn ein Fotorezeptor nach der Installation einen Defekt aufzuweisen scheint, legen Sie diesem Formular bitte die nachstehend beschriebenen Testkopien bei, um eine genaue Beurteilung der Mängel zu ermöglichen. Das Formular sowie die Testkopien dürfen bei der Rücksendung auf keinen Fall mit der Oberfläche des Fotorezeptors in Berührung kommen.

FÜR FOTOREZEPTOREN, DIE IN KOPIERERN BENUTZT WURDEN, folgende Testkopien beilegen:

- (a) 3 schwarze Kopien (bei offener Vorlagenglas-Abdeckung),
- (b) 3 weiße Kopien und
- (c) 3 Testkopien (vom Testbogen).

BITTE BEACHTEN: Ist der Defekt auf diesen Mustern nicht sichtbar, legen Sie bitte 3 Kopien bei, auf denen er deutlich zu erkennen ist.

FÜR FOTOREZEPTOREN, DIE IN DRUCKERN UND NORMALPAPIER-FAXGERÄTEN BENUTZT WURDEN, legen Sie bitte 3 Kopien bei, auf denen der Defekt deutlich zu erkennen ist.

WICHTIG: Schäden, die durch falsche Bedienung des Endanwenders, durch den Techniker oder das Gerät verursacht wurden (d. h. umlaufende Kratzer, Streifen, Abrieb oder querlaufende Kratzer), sind von der Katun Qualitätsgarantie ausgeschlossen.

4. Versandrichtlinien

ALLE TEILE, DIE AN UNS ZURÜCKGESANDT WERDEN, MÜSSEN SACHGEMÄSS VERPACKT SEIN, d. h. in dem entsprechenden Einzelkarton und einem zweiten Karton mit entsprechendem Verpackungsmaterial. Dies betrifft jeglichen Transportweg!

BITTE BEACHTEN: Teile, die nicht sachgemäß verpackt werden und uns aus diesem Grunde defekt erreichen, sind von der Katun-Qualitätsgarantie ausgeschlossen und werden nicht angenommen.

Schicken Sie Ihre Reklamation zur technischen Bewertung (frachtfrei) an die für diese Zwecke im Katun-Online-Katalog und dem gültigen regulären Katalog unter den „allgemeinen Hinweisen“ angegebene Adresse. Katun übernimmt keinerlei Verantwortung für Reklamationen, die an eine andere Adresse als die oben genannte geschickt werden. **Schicken Sie Reklamation zum Ersatz ohne Bewertung an Ihren Katun-Ansprechpartner.**

