

## Katun Products for use in

**Minolta**

## Table of Contents

	<i>Page</i>
<b>Copy Machine Equivalency List</b> .....	i
<b>Descriptions of Katun Product Brands and Technologies</b> .....	vii
<b>Beschreibungen der Produktmarken und Technologien von Katun</b> .....	ix
<b>Personalized Product Agreement</b> .....	xi
<b>Vereinbarung Über Bestellung Von Produkten Mit Ihrem Firmenetikett</b> .....	xiii
<b>Bearings/Bushings</b> .....	1
<b>Belts</b> .....	5
<b>Blades/Brushes</b> .....	6
<b>Corona/Charge/Transfer</b> .....	8
<b>Developers</b> .....	11
<b>Electrical</b> .....	12
<b>Feed/Delivery</b> .....	13
<b>Filters</b> .....	16
<b>Fuser Cleaning</b> .....	17
<b>Fuser Oil</b> .....	19
<b>Kits</b> .....	20
<b>Lamps</b> .....	22
<b>Memory Upgrades</b> .....	23
<b>Photoreceptors</b> .....	24
<b>Picker Fingers</b> .....	28
<b>Rollers, Fuser/Heat</b> .....	29
<b>Rollers, Pressure</b> .....	31
<b>Thermal Control Devices</b> .....	33
<b>Toners/Toner Cartridges</b> .....	34
<b>Waste Toner Containers</b> .....	38
<b>General Information</b> .....	I
<b>Allgemeine Hinweise</b> .....	III
<b>Distributor Choice Warranty Claim Form</b> .....	V
<b>HÄNDLER-GARANTIEFORMULAR</b> .....	VII



## Copy Machine Equivalency List

Central/Eastern Europe  
 Telephone: 31(0)183-696969  
 Fax: 31(0)183-629055  
 E-mail: order@edc.katun.com

Minolta	Agfa	Develop	Konica	Panasonic
CF 900		DFC 100	7723	
CF 910		DFC 110	7823	
CF 1501		QC 1500	7915	
CF 2001		QC 2000	7920	
CF 2002		QC 2001	8020	
CF 3102		QC 3101	8031	
CF 5001			ColorFORCE 8050	
			KL 5100	
CF 9001		DFC 800	7832	
Di 30		D 3000 iD		
Di 150 f		D 1550 iD		
Di 151		D 1530 iD	7415	
Di 151 f		D 1530 iD F	7415 FAX	
Di 152		D 1531 iD	7115	
Di 152 f		D 1536 iD	7115 F	
Di 181		D 1830 iD		
Di 183		D 1831 iD	7118	
Di 183 f		D 1836 iD	7118 F	
Di 250		D 2500 iD		
Di 250 f		D 2530 iD		
Di 251		D 2501 iD		
DI 251 F		D 2501 iD		
Di 350		D 3500 iD		
Di 350 f		D 3530 iD		
Di 351		D 3501 iD		
DI 351 F		D 3501 iD		
Di 450		D 4500 iD		
Di 470		D 4700 iD		
Di 520		D 5200 iD		
Di 550		D 5500 iD		
Di 551		D 5510 iD	7155	
Di 620		D 6200 iD		FP D620
Di 650		D 6500 iD	7165	
Di 750			7075	
Di 850			7085	
DI 1611			7216	
DI 2011			7220	
DI 2510		D 2556 iD		
Di 2510 f		D 2556 iD		
DI 3510		D 3556 iD		
DI 3510 F		D 3556 iD		
DI 5510			7255	
DI 7210			7272	
EP 30		100		
EP 50	X 15	200		
EP 70		D 700		
EP 370		151		
EP 370 Z		151 Z		
EP 410 S	X 25 -1			
EP 410 Z	X 25 -3	500 Z		
EP 415 Z	X 25 -5			
EP 425 Z		213 Z		
EP 470 Z	X 35 -1			
	X 35 -3			

## Copy Machine Equivalency List

Minolta	Agfa	Develop	Konica	Panasonic
EP 490 Z		307 Z		
EP 570 Z		408 Z		
EP 1030		D 1300		
EP 1030 F		D 1300 F		
EP 1031		D 1320		
EP 1031 F		D 1320 F		
EP 1050		D 1500		
EP 1052		D 1501		
EP 1054		D 1502		
EP 1080		D 1850		
EP 1083	X 120	D 1800		
EP 1085		D 1801		
EP 2010		D 2150		
EP 2030		D 2350		
EP 2050		D 2550		
EP 2051	X 220	D 2551		
EP 2080		D 2850		
EP 2100		1010		
EP 2120		1211		FP 1270
EP 2121		1212		FP 1275
EP 2130		1311		FP 1370
EP 2131		1312		
EP 2150		1511		
EP 2151		1512		
EP 2152		1513		
EP 2153		1514		
EP 3010		D 3150		
EP 3050	X 310	D 3550		
EP 3120	X 18	1210		
EP 3150	X 18 -15	1510		
EP 3170		1710		
EP 4000	X 420	D 4050		
EP 4050	X 410	D 4550		
EP 4210		2100		
EP 4230	X 28	2360		
EP 4233	X 200	2361		
EP 4250		2500		
EP 4300	X 38	3060		
EP 5000	X 520	D 5050		
EP 5325	X 300	3250		
EP 5400	X 48	4060		
EP 5425		4250		
EP 6000		D 6050		FP 7160
EP 6001		D 6051		FP 7760
EP 8010		D 8150		FP 7181
EP 8015		D 8151		FP 7781
EP 8600		6060		FP 6070
EP 8602		6061		
EP 8605		6062		
EP 9765		7650		
A- 15		A- 15		
AD- 1	DPX- A	AD- 1		
AD- 2	AD- 2	AD- 2		

## Copy Machine Equivalency List

Central/Eastern Europe  
 Telephone: 31(0)183-696969  
 Fax: 31(0)183-629055  
 E-mail: order@edc.katun.com

Minolta	Agfa	Develop	Konica	Panasonic
AD- 3		AD- 3		
AD- 4		AD- 4		
AD- 5	DPX- C	AD- 5		
AD- 7		AD- 7	AD- 723	
AD- 8	AD- 8	AD- 8		
AD- 9	AD- 9	AD- 9		
AD- 11		AD- 11		
AF- 1	AF- 1	AF- 1		
AF- 2	AF- 2	AF- 2		
AF- 3		AF- 3		
AF- 4		AF- 4		
AF- 5	AF- 5	AF- 5		
AF- 6		AF- 6		
AF- 7		AF- 7		
AF- 8		AF- 8	DF- 216	
AF- 9		AF- 9		
AF- 10		AF- 10	DF- 217	
AF- 15	AF- 15	AF- 15		
AFR- 1	ADFR- A	AFR- 1		
AFR- 2		AFR- 2		A- 780
AFR- 3	AFR- 3	AFR- 3		
AFR- 4		AFR- 4		AFR- 4
AFR- 5		AFR- 5		
AFR- 6		AFR- 6		
AFR- 7		AFR- 7		
AFR- 8		AFR- 8		
AFR- 9	ADFR- E	AFR- 9	AFR- 9 DF- 723	A- 910
AFR- 10		AFR- 10		A- 901
AFR- 12	AFR- 12	AFR- 12	DF- 724	
AFR- 13	AFR- 13	AFR- 13		A- 920
AFR- 14		AFR- 14		
AFR- 16		AFR- 16	DF- 331	
AFR- 17	ADFR- 4	AFR- 17		
AFR- 18			DF- 332	
AFR- 1000		AFR- 1000		A- 990
C- 101		C- 101	LT- 723	
C- 201	PF- A	C- 201		
C- 202		C- 202		L- 2060
C- 203	C- 203	C- 203		
C- 204	C- 204	C- 204		
C- 205		C- 205		
C- 301	C- 301	C- 301		
C- 302		C- 302		L- 3000
C- 303		C- 303		L- 3005
C- 304		C- 304		L 3010
C- 304 L		C- 304 L		L 3020
C- 305			LT- 401	
C- 305 L			LT- 411	
C- 401		C- 401		
C- 402		C- 402		L- 4001
C- 403		C- 403	LT- 402	
C- 404		C- 404	LT- 412	

## Copy Machine Equivalency List

Minolta	Agfa	Develop	Konica	Panasonic
C- 500 3	SF- 4	C- 500 3		
C- 2000	PF- 4	C- 2000		
COVER INSERTER- A			PPI- 108	
EDH- 1		EDH- 1		A- 620
EDH- 2			DF- 313	
EDH- 3		EDH- 3		
EDH- 4		EDH- 4	DF- 316	
EDH- 5			DF- 317	
F- 15	DF- 2	F- 15		
FIERY- X2		FIERY- X2	KR- X2	
FIERY- X2 E		FIERY- X2 e	FIERY- X2 e	
FIERY- X3 e		FIERY- X3 e	FIERY- X3 e	
FIERY- X4		FIERY- X4	FIERY- X4	
FIERY- Z4			FIERY- Z4	
FIERY- Z5		FIERY- Z5	FIERY- Z5	
FIERY- ZX 2100		FIERY- ZX 2100	KR- ZX 2100	
FIERY- ZX 3300		FIERY- ZX 3300	KR- ZX 3300	
FN- 1		FN- 1		F- 500
FN- 3		FN- 3		F 640
FN- 4			FS- 108 B	
FN- 6		FN- 6	FS- 110	
FN- 7			FS- 211	
FN- 8			FS- 231	
FN- 100		FN- 100		
FN- 102				F 620
FN- 104			FS- 108	
FN- 107		FN- 107	FS- 133	
FN- 108		FN- 108	FS- 134	
FN- 109		FN- 109		
FN- 110		FN- 110		
FN- 112		FN- 113	FS- 210	
FN- 113		FN- 113	FS- 210	
FN- 115			FS- 111	
FN- 116			FS- 135	
FN- 500		FN- 500		
FN- 502				F 630
FN- 504		FN- 504		
HP- 1		HP- 1		SP- 810
IP- 602			IP- 602	
JS- 1002		JS- 1002	ST- 134	
MB- 1		MB- 1		
MB- 4	MB- 4	MB- 4		
MB- 5		MB- 5	MT- 102	
PF- 2D		PF- 2D		
PF- 4D	PF- 4D	PF- 4D		
PF- 5D	PF- 5D	PF- 5D		
PF- 6D		PF- 6D		
PF- 7D		PF- 7D		
PF- 102		PF- 102		
PF- 104	PF- 104	PF- 104		
PF- 105	PF- 105	PF- 105		
PF- 106		PF- 106		
PF- 108		PF- 108		

## Copy Machine Equivalency List

Central/Eastern Europe  
 Telephone: 31(0)183-696969  
 Fax: 31(0)183-629055  
 E-mail: order@edc.katun.com

Minolta	Agfa	Develop	Konica	Panasonic
PF- 110		PF- 110		
PF- 112		PF- 112		
PF- 115		PF- 115		
PF- 116		PF- 116	PF- 120	
PF- 117		PF- 117	DB- 431	
PF- 118		PF- 118	PF- 231 PF- 232	
PF- 119		PF- 119		
PF- 120		PF- 120	PF- 121	
PF- 121			DB- 432	
PF- 201		PF- 201		
PF- 202		PF- 202		
PF- 204	PF- 204			
PF- 205	PF- 205	PF- 205		
PF- 206		PF- 206		
PF- 208		PF- 208		
Pi- 1802 e		Pi- 1802 e	IP- 413	
PI- 3502		Pi- 3502		
Pi- 5501		Pi- 5501		
PI- 6500		Pi- 6500	IP- 511	
PI- 7500			IP- 601	
RDH- 1				F- 800
S- 10 VI	S- 10 VI			
S- 10 VII	S- 2-1	S- 10 VII		
S- 20 III	S- 4-1			
S- 20 IV	S- 20 IV	S- 20 IV		
S- 20 VI		S- 20 VI		S- 430
S- 101	S- 101	S- 101		
S- 103	S- 103	S- 103		
S- 104		S- 104		
S- 105		S- 105	ST- 723	
S- 106	S- 106	S- 106		
S- 201	SRT- A	S- 201		
S- 202		S- 202		S- 420
S- 203	S- 203	S- 203		
S- 204		S- 204		
S- 205	SRT- 20 D			
S- 206		S- 206		S- 700
S- 207		S- 207		
S- 208	S- 208	S- 208		
S- 209		S- 209		S- 720
ST- 101	STS- 10 A	ST- 101		
ST- 103		ST- 103	ST- 724	
ST- 104	ST- 104	ST- 104		
ST- 201		ST- 201		S- 490
ST- 202	ST- 202	ST- 202		
ST- 203		ST- 203		
ST- 204		ST- 204		
ST- 206	STS- 20 D	ST- 206		
ST- 207		ST- 207		S- 710
ST- 208		ST- 208		S- 810
ST- 210		ST- 210		
ST- 211	ST- 211	ST- 211		



## Copy Machine Equivalency List

Minolta	Agfa	Develop	Konica	Panasonic
ST- 212		ST- 212		S- 740
ST- 213		ST- 213		S- 750
ST- 214	ST- 214	ST- 214		
ST- 1000		ST- 1000		
ST- 1100		ST- 1100		S- 755
ST- 1200		ST- 1200		
T- 301	T- 301	T- 301		
T- 302		T- 302		UF- 60
T- 303		T- 303		T- 303
T- 312		T- 312		T- 312
TMG- 2			TU- 108	

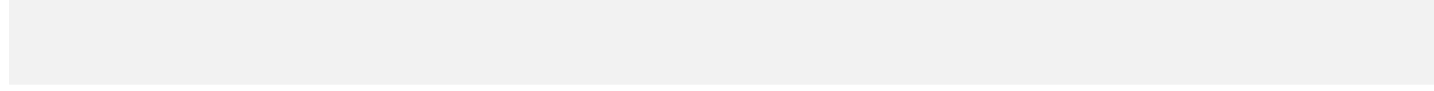
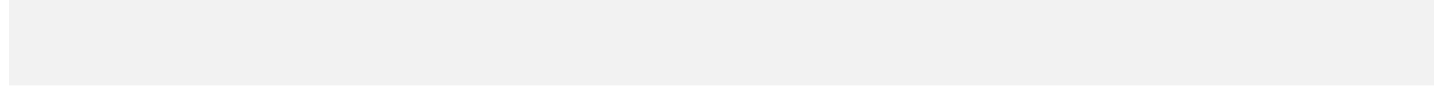
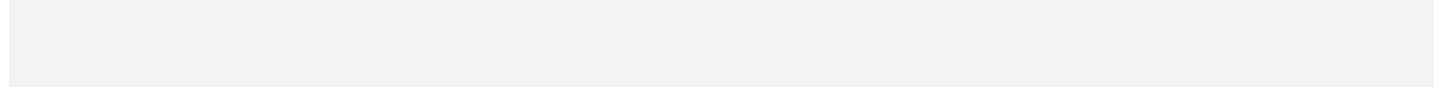
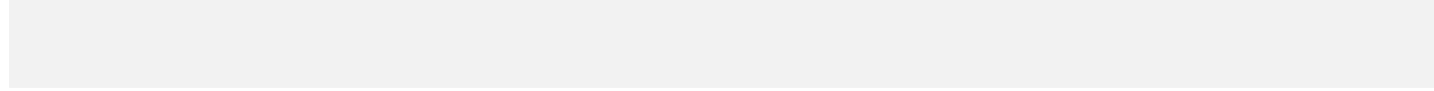
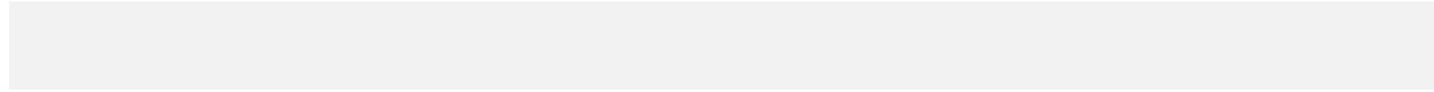
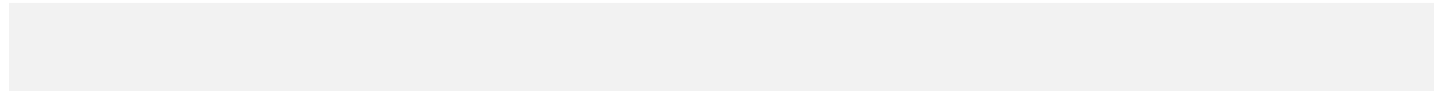

## Descriptions of Katun Product Brands and Technologies

### Katun Performance Products

Katun Performance is our complete line of office automation products that combine our highest quality level with consistent, reliable performance and competitive pricing - and provide excellent overall value.

Katun Performance products meet strict quality guidelines and have been 100% tested and approved according to the Katun 360° Certification process, which includes environmental testing, forward and reverse compatibility testing, model application testing, and component compatibility testing. In addition, all Katun Performance products are warranted to be free from functional defects in material and workmanship for one year and come with the highest level of Katun technical support.

To locate Katun Performance products, look for the Katun Performance icon  throughout this catalog.

### Access by Katun Products

Access by Katun is a line of selected products that address the unique pricing or product needs of specific markets. Access by Katun products provide market acceptable quality and market competitive pricing. The Access by Katun product line complements the Katun Performance line by providing a value proposition based primarily on specific market needs.

Access by Katun products come with a limited level of product support and a one-year warranty. Although Access by Katun products provide some price advantages, remember that Katun Performance products always provide excellent overall value.

### Original Products

Select OEM brand products that Katun offers to meet certain market needs

## Fuser Roller Coating Technologies

Minco Manufacturing, Inc., a wholly owned subsidiary of Katun Corporation, is a world-leading manufacturer of fuser rollers for use in plain paper copiers, facsimiles, and printers. The product development relationship between Katun, Minco, and DuPont, the exclusive manufacturer of genuine TEFLON<sup>®</sup> brand coatings, has produced numerous advanced fuser roller coating technologies, including:

**DURAPREM<sup>™</sup> II upper fuser rollers** are manufactured with a heat-resistant, nonstick TEFLON<sup>®</sup> brand coating that provides increased surface hardness for extended potential life. A proprietary finishing process produces an exceptionally smooth surface, which contributes to these rollers' excellent fusing performance and toner release in machines using negative-charge toner.

**DURACON<sup>™</sup> II upper fuser rollers** are manufactured with a heat-resistant, nonstick TEFLON<sup>®</sup> brand coating that includes patented conductive additives for static dissipation. These rollers provide excellent fusing performance, toner release, and long life, primarily in machines using positive-charge toner.

**ALUMANA<sup>™</sup> upper fuser rollers** are manufactured with extremely hard, tough primer and midcoat layers for maximum resistance to wear and abrasion. The ceramic ALUMANA coating combines a DuPont-patented polymer blend with reinforcing oxides for enhanced durability. These heavy-duty rollers are specifically designed to meet the demands of hostile fuser station environments and higher-speed machines using either positive-charge or negative-charge toner.

**TRITON<sup>™</sup> II upper fuser rollers** are manufactured with an advanced TEFLON<sup>®</sup> brand coating that provides improved fusing performance and nonstick characteristics in comparison to conventional fluoropolymer coatings. Unique static-dissipative particulates within the TRITON II coating, together with enhanced manufacturing processes, contribute to these rollers' superior abrasion-resistance and excellent toner release. These rollers provide extended potential life in selected machines using either positive-charge or negative-charge toner.

## Central/Eastern Europe

Telephone: 31(0)183-696969

Fax: 31(0)183-629055

E-mail: [order@edc.katun.com](mailto:order@edc.katun.com)

**TRITON BLUE™ upper fuser rollers** deliver excellent performance for machine applications that are tough on fuser rollers. Manufactured with an advanced TEFLON® brand coating that provides improved fusing performance and nonstick characteristics in comparison to conventional fluoropolymer coatings, TRITON BLUE™ fuser rollers combine improved wear resistance with superior abrasion-resistance and excellent toner release.

**TUF/SIL™ upper fuser rollers** are manufactured with a layer of silicone rubber that effectively regulates heat flow to the toner, plus an outermost layer that consists of a specially blended TEFLON® brand coating providing excellent toner release and abrasion-resistance. This combination ensures reduced toner offsetting and improved, more consistent copy quality under certain demanding machine usage conditions. These rollers provide a high-performance, cost-effective solution for selected machines required to consistently produce the best possible copy quality.

**MICROSLEEVE™ lower pressure rollers**, with nonstick PFA sleeves 50, 70, or 100 microns in thickness, provide excellent wear-resistance for improved copy quality over an extended life. A-Series MICROSLEEVE™ lower pressure rollers are designed specifically for machines utilizing lower fuser cleaning rollers. Their unique surface texture reduces toner buildup and improves cleaning efficiency within the fuser station.

All Katun fuser rollers are designed specifically for their intended applications and manufactured to exacting quality standards, ensuring their excellent performance and long life.

## Fuser Cleaning Roller Coating Technologies

Katun has introduced unique fuser cleaning roller technologies for machines requiring efficient removal and absorption of excess toner and contaminants, as well as continuous silicone oil lubrication of critical fuser station parts. For many machines, the ideal parts combination for achieving optimum copy quality and maximum parts life includes a specially designed Katun fuser cleaning roller.

**FIBRA™ fuser cleaning rollers** incorporate a uniform network of special fibers that aggressively remove excess toner and contaminants from the contacted surface. By efficiently depositing toner and contaminants beneath its outermost surface, the unique FIBRA network also helps maintain a continuous lubricative flow of silicone oil from the roller's internal tank to critical fuser station parts.

**FIBRA™ II fuser cleaning rollers** incorporate a unique configuration of highly heat-resistant fibers to greatly enhance cleaning performance, especially in hostile fuser station environments. Efficient absorption of excess toner and contaminants, together with continuous silicone oil lubrication of critical fuser station parts, effectively reduce parts and service expenses associated with the fuser station.

TEFLON® is a registered trademark of E.I. DuPont de Nemours and Company used under license by Katun Corporation.

## Personalized Product Program

Katun offers an extremely cost-effective way for office equipment dealers/distributors to ensure repeat business and strengthen relations with customers. The **Personalized Product program** enables dealers/distributors to provide high-quality Katun Performance imaging supplies (toner, fax and printer toner cartridges, digital duplicator inks and masters and thermal transfer ribbons) with their business name and /or logo, plus contact information, so end-users always know whom to call to reorder. For a one-time, nominal set-up fee, Katun designs and produces full-color labels to customer specifications and applies them to packaging at no extra charge. Only end-user-replaceable Katun Performance products are eligible under the program. Enrollment is simple and easy. Just complete the agreement form and submit it to your Katun sales representative or visit the Personalized Products page for more program and enrollment information.



## **Beschreibungen der Produktmarken und Technologien von Katun**

### **Katun Performance-Produkte**

Katun Performance ist unsere umfangreiche Produktreihe von Büromaschinenprodukten, die sich durch hohe Qualität sowie durch beständige, zuverlässige Leistung und attraktive Preise auszeichnen. Mit diesen Produkten soll der Nutzwert für den Kunden maximiert werden.

Katun Performance -Produkte erfüllen strenge Qualitätsstandards und wurden alle im Rahmen des 360° -Zertifizierungsverfahrens von Katun getestet und freigegeben. Die Produkte durchlaufen dabei Prüfungen der Umweltverträglichkeit, der Kompatibilität, der Modellanwendungen und der Komponentenkompatibilität. Darüber hinaus wird bei allen Katun Performance-Produkten ein Jahr lang gewährleistet, dass diese frei von funktionalen Material- und Verarbeitungsfehlern sind. Selbstverständlich steht Ihnen auch der hochwertige technische Support von Katun zur Verfügung.

**Um die Katun Performance-Produkte zu finden, halten Sie in diesem Katalog nach dem Namen Performance  und dem entsprechenden Symbol Ausschau.**

### **Originalprodukte**

Sie können verschiedene OEM-Produkte auswählen, die Katun aufgrund der Nachfrage auf dem Markt in sein Produktangebot aufgenommen hat.

### **Beschichtungstechnologien für Heizwalzen**

Minco Manufacturing Incorporated, eine hundertprozentige Tochtergesellschaft der Katun Corporation, ist einer der weltweit führenden Hersteller von Heizwalzen für Kopierer, Faxgeräte und Drucker. Die enge Zusammenarbeit zwischen Katun, Minco und DuPont, dem alleinigen Hersteller originaler TEFLON® - Beschichtungen, hat zur Entwicklung von zahlreichen neuartigen Beschichtungsmaterialien für Heizwalzen geführt:

**DURAPREM™ II** Heizwalzen sind mit einer temperaturbeständigen TEFLON® - Antihaf-Beschichtung ausgestattet und besitzen daher eine größere Oberflächenhärte für eine potenziell längere Lebensdauer. Die nach einem speziellen Finish-Verfahren hergestellte, außerordentlich glatte Walzenoberfläche bietet hervorragende Fixier- und Antihaf-Eigenschaften in Geräten mit negativ geladenem Toner.

**DURACON™ II** Heizwalzen sind mit einer temperaturbeständigen TEFLON® - Antihaf-Beschichtung ausgestattet, der patentierte, elektrisch leitfähige Inhaltsstoffe beigemischt sind, um das Ableiten von sich bildender statischer Ladung zu ermöglichen. Diese Heizwalzen zeichnen sich durch ihre hervorragenden Fixier- und Antihaf-Eigenschaften sowie eine lange Nutzungsdauer aus, besonders in Geräten mit positiv geladenem Toner.

**ALUMANA™** Heizwalzen besitzen eine äußerst harte, widerstandsfähige Grund- und Zwischenschicht für eine höchstmögliche Verschleißfestigkeit und Haltbarkeit. Die ALUMANA Keramiksicht beinhaltet eine patentierte Polymer-Mischung von DuPont mit Verstärkungsoxiden für eine erhöhte Widerstandsfähigkeit.

Diese robusten Heizwalzen sind speziell für anspruchsvolle Betriebsbedingungen in der Fixierstation und für schnellere Kopierer mit positiv oder negativ geladenem Toner konstruiert.

**TRITON™ II Heizwalzen** zeichnen sich durch ihre hochwertige TEFLON® -Beschichtung aus, die herkömmlichen Fluorpolymer-Beschichtungen in Bezug auf Fixier- und Antihaf-Eigenschaften überlegen ist. Spezielle antistatisch wirkende Partikel in der TRITON II-Beschichtung und hohe Fertigungsstandards tragen zu den ausgezeichneten Antihaf-Eigenschaften und der hervorragenden Verschleißfestigkeit dieser Heizwalzen bei.

Sie bieten potentiell längere Laufzeiten in ausgewählten Geräten sowohl mit positiv als auch mit negativ geladenem Toner.

## Central/Eastern Europe

Telephone: 31(0)183-696969

Fax: 31(0)183-629055

E-mail: [order@edc.katun.com](mailto:order@edc.katun.com)

**TUF/SIL™ Heizwalzen** besitzen eine Silikonbeschichtung, die für eine effiziente regulierte Wärmeableitung an den Toner sorgt, sowie eine besonders zusammengesetzte TEFLON® - Beschichtung mit ausgezeichneten Antihaft-Eigenschaften und hoher Verschleißfestigkeit. Dies führt zu weniger Toner-Offsetting-Problemen und gewährleistet auch unter anspruchsvollen Betriebsbedingungen eine gleichbleibend hohe Kopienqualität. Die TEFLON®/SILIKON Heizwalzen bieten ein sehr gutes Preis-/Leistungsverhältnis für ausgewählte Geräte, die höchste Qualitätsansprüche in Bezug auf die Kopienqualität stellen.

**MICROSLEEVE™** Presswalzen mit Antihaft-PFA-Ummantelung in den Stärken 50, 70 und 100 µm bieten eine außergewöhnliche Haltbarkeit und damit eine langfristig bessere Kopienqualität und längere Nutzungsdauer. Die Presswalzen der MICROSLEEVE™ A-Serie sind speziell für den Einsatz in Geräten gedacht, bei denen eine Reinigung der unteren Presswalze mittels Reinigungswalze stattfindet.

Ihre besondere Oberflächenstruktur reduziert Tonerablagerungen und verbessert die Reinigungswirkung in der Fixierstation.

Alle Heizwalzen von Katun wurden speziell im Hinblick auf deren Einsatzzweck entwickelt und erfüllen höchste Qualitätsstandards. Nicht umsonst zeichnen sie sich durch eine herausragende Leistung und eine lange Nutzungsdauer aus.

## Beschichtungstechnologien für Reinigungswalzen

Katun hat spezielle Reinigungswalzen für Geräte entwickelt, die eine wirksame Beseitigung von Tonerresten und Schmutz sowie eine kontinuierliche Versorgung wichtiger Teile der Fixierstation mit Silikonöl erfordern. Durch den Einsatz einer Katun Reinigungswalze kann bei vielen Geräten eine optimale Kopienqualität und eine größtmögliche Nutzungsdauer der Komponenten erzielt werden.

**FIBRA™** Reinigungswalzen entfernen Tonerreste und Schmutzpartikel durch ein spezielles Fasernetz effizient von der Walzenoberfläche. Während das FIBRA-Fasernetz die Verschmutzungen wirkungsvoll in seiner Oberfläche aufnimmt, sorgt es zugleich für eine Dauerversorgung wichtiger Teile der Fixierstation mit Silikonöl aus dem Vorratstank im Walzeninneren.

**FIBRA™II** Reinigungswalzen besitzen ein neuartiges, hitzebeständiges Fasernetz, mit denen besonders unter anspruchsvollen Betriebsbedingungen eine erheblich verbesserte Reinigungswirkung erzielt wird.

Durch die wirksame Aufnahme von Tonerresten und Schmutzstoffen bei gleichzeitiger Dauerversorgung wichtiger Teile in der Fixierstation mit Silikonöl können die Austausch- und Servicekosten für die Fixierstation erheblich gesenkt werden.

TEFLON® ist ein eingetragenes Warenzeichen von E.I. DuPont de Nemours and Company und wird von der Katun Corporation unter Lizenz verwendet.

## Firmenetiketten-Programm

Katun bietet Händlern einen äußerst kostengünstigen Weg, ihre Kunden an sich zu binden und Kundenbeziehungen zu verbessern. Das **Firmenetiketten-Programm** erlaubt es Händlern, qualitativ hochwertige Verbrauchsmaterialien von Katun Performance (Toner, Drucker-/Faxkartuschen, Tinten für Digitalkopierer und Thermotransferrollen) mit ihrem Firmennamen und/oder Logo sowie mit Kontaktinformationen zu versehen. So wissen Verbraucher immer, bei wem sie Produkte nachbestellen können. Für eine einmalige, geringe Bearbeitungsgebühr entwirft und produziert Katun Performance vollfarbige Etiketten nach Ihren eigenen Angaben. Diese werden kostenfrei auf die entsprechenden Verpackungen aufgebracht. Unter dieses Programm fallen nur Produkte, die vom Endverbraucher nachbestellt werden können. Die Teilnahme an dem Programm ist ganz einfach. Füllen Sie einfach die Vereinbarung aus und senden Sie diese an Ihren Katun- Ansprechpartner oder besuchen Sie uns auf unserer Homepage unter Firmenetiketten-Programm für weitere Information zu diesem Programm und den Teilnahmebedingungen.

## Personalized Product Agreement

### Customer Information

Customer Number: \_\_\_\_\_ Phone Number: \_\_\_\_\_  
 Contact Name: \_\_\_\_\_ Fax Number: \_\_\_\_\_  
 Title: \_\_\_\_\_ Katun Representative: \_\_\_\_\_

### Customer agrees to:

- Provide pertinent information, a scanable copy of your company logo, or other desired label artwork, and color specifications for the labels.
- Pay a one-time, nominal setup fee upon approval of the label design. (Ask your sales representative for details.)
- Order in full master carton quantities.

### Katun agrees to:

- Create a personalized, full-color label design to your specifications, per the information provided on page two of this form, for a one-time, nominal setup fee and send a proof for approval within a minimum of 7 days of receipt of this agreement.
- Produce labels printed with the customer's approved design on white label stock, and affix them over the Katun Performance logo\* on copier toner, printer/fax toner cartridge, digital duplicator ink/master packaging.
- Ship initial order within one week after the customer approves their Personalized Product label proof. Reorders will also ship within one week.

### Projected Personalized Product Purchases

Katun Part Number**	OEM Line	Product/Model Description	Minimum Order Quantity	Projected Monthly Order***
P			One master carton	
P			One master carton	
P			One master carton	
P			One master carton	
P			One master carton	
P			One master carton	

Signature: \_\_\_\_\_ Date: \_\_\_\_\_

\*Only Katun Performance products can be personalized.

\*\*The Personalized Product part number is the regular Katun Performance part number with a 'P' added at the end. See the Katun catalog for master carton quantities.

\*\*\***Projection only.** You are not committed to ordering the quantity you list on this form.

NOTE: Products with personalized labels cannot be returned to Katun for credit unless a valid warranty claim exists.

**Please Also Complete Page 2**

Central/Eastern Europe  
Telephone: 31(0)183-696969  
Fax: 31(0)183-629055  
E-mail: order@edc.katun.com

## Information for Personalized Product Label

Please list *only* the information you want to appear on your Personalized Product label.

**Company Name:** \_\_\_\_\_

**Street Address:** \_\_\_\_\_

**City:** \_\_\_\_\_

**State/Province:** \_\_\_\_\_ **Postal Code:** \_\_\_\_\_

**Phone Number:** \_\_\_\_\_ **Fax Number:** \_\_\_\_\_

**Other:** \_\_\_\_\_

## Label Artwork

- **Attach a copy of your company logo and/or any other requested graphic elements.** Artwork may be full color or black and white. We prefer original-quality artwork 4" x 4" (100mm x 100mm) or larger, but will accept a business card or sheet of company letterhead.
- **Please indicate your color preferences.** In the space below, please indicate the color(s) you want to use for all text, your company logo, and any other graphic elements. If appropriate, please supply accurate samples to be matched or specify Pantone or PMS color numbers. **NOTE:** Your labels will be printed on a thermal-transfer printer at a resolution of 300 dpi. Therefore color photographs cannot be printed and some colors may be difficult to match precisely.

## Label Sizes

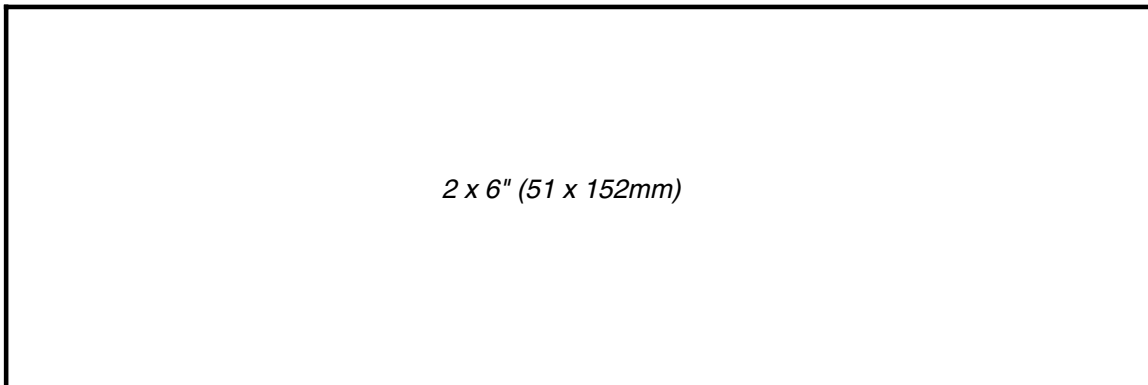
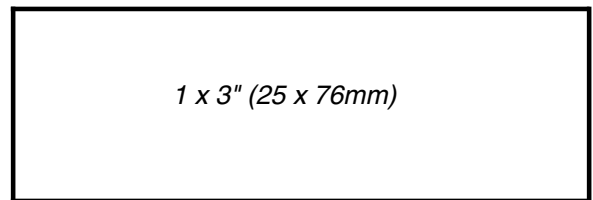
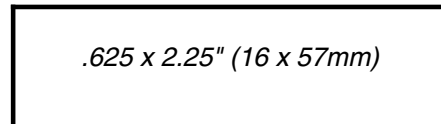
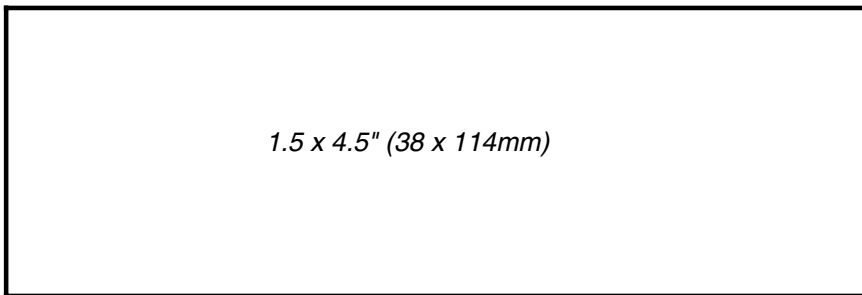

## Vereinbarung über Bestellung von Produkten mit Ihrem Firmenetikett

### Kundeninformationen

Kundennummer: \_\_\_\_\_ Telefon: \_\_\_\_\_  
 Ansprechpartner: \_\_\_\_\_ Fax: \_\_\_\_\_  
 Position: \_\_\_\_\_ Ihr Katun-Repräsentant: \_\_\_\_\_

### Der Kunde ist einverstanden:

- Katun die benötigten Informationen vorzulegen (ein zum Scannen geeignetes Muster Ihres Firmenlogos bzw. Muster anderer gewünschter Grafikelemente sowie Farbspezifikationen für die Etiketten);
- nach Genehmigung des Etiketten-Layouts eine einmalige, geringe Bearbeitungsgebühr zu entrichten. Weitere Informationen erhalten Sie von Ihrem Katun-Repräsentanten;
- Toner in den jeweiligen Verpackungseinheiten/Umkartons zu bestellen.

### Katun verpflichtet sich:

- ein Vollfarbetikett nach den Kundenangaben zu entwerfen (siehe Seite 2 dieses Formulars). Hierfür wird eine einmalige, geringe Bearbeitungsgebühr erhoben. Nach Eingang dieser Vereinbarung bei Katun erhält der Kunde innerhalb von ca. sieben Werktagen einen Korrekturabzug.
- Etiketten in Standardgröße mit dem vom Kunden genehmigten Layout auf weißem Etikettenpapier zu drucken und über dem Katun Performance-Logo\* auf der Verpackung von Toner für Kopierer, Tonerkartuschen für Drucker/Faxgeräte, Tinte bzw. deren Umkartons für digitale Duplikatoren anzubringen.
- den Toner-Erstauftrag innerhalb von einer Woche nach Genehmigung des firmeneigenen Etiketts zu versenden. Nachbestellungen werden ebenfalls innerhalb einer Woche erledigt.

### Erwartete Abnahmemenge von Produkten mit Ihrem Firmenetikett

Katun Artikelnummer**	Maschinenlinie	Produkt-/Modellbeschreibung	Mindestmenge	Erwartete monatliche Bestellung***
P			Ein Umkarton	
P			Ein Umkarton	
P			Ein Umkarton	
P			Ein Umkarton	
P			Ein Umkarton	
P			Ein Umkarton	

Unterschrift: \_\_\_\_\_ Datum: \_\_\_\_\_

\*Nur Katun Performance Produkte können mit Firmenetiketten bestellt werden.

\*\*Die Artikelnummer für Produkte mit Ihrem Firmenetikett ist die normale Katun Performance Artikelnummer, der ein "P" am Ende nachgestellt ist. Sehen Sie die Umkartonmengen im Katun-Katalog nach.

\*\*\*Nur Schätzungen. Sie sind nicht verpflichtet, die hier angegebene Menge abzunehmen.

HINWEIS: Produkte mit Firmenetiketten können nur bei einer berechtigten Reklamation gutgeschrieben werden.

**Füllen Sie bitte auch Seite 2 aus.**

## Bestellinformationen für firmeneigenes Etikett

Geben Sie bitte *nur* die Informationen an, die auf dem Etikett erscheinen sollen.

Name der Firma: \_\_\_\_\_

Strasse: \_\_\_\_\_

PLZ/Ort: \_\_\_\_\_

Telefon: \_\_\_\_\_ Fax: \_\_\_\_\_

Sonstiges: \_\_\_\_\_

## Layout des Etiketts

- **Bitte legen Sie kein Muster Ihres Firmenlogos sowie ggf. Muster anderer gewünschter Grafikelemente bei.** Geeignet sind Grafiken in Farbe oder Schwarzweiß, vorzugsweise Originale mit einer Mindestgröße von 100 x 100 mm. Wir können auch Ihre Visitenkarte oder Ihren Briefkopf verarbeiten.
- **Bitte geben Sie die gewünschten Farben an.** Tragen Sie unten bitte die Farbe(n) für alle Textelemente, Ihr Firmenlogo sowie andere grafische Elemente ein. Legen Sie ggf. ein Farbmuster bei, oder geben Sie die Pantone- bzw. PMS-Farbnummern an.  
**HINWEIS:** Ihre Firmenetiketten werden auf einem Thermodrucker mit einer Auflösung von 300 DPI erstellt. Es können daher keine Farbfotos gedruckt werden, und bestimmte Farben können u. U. nicht exakt wiedergegeben werden.





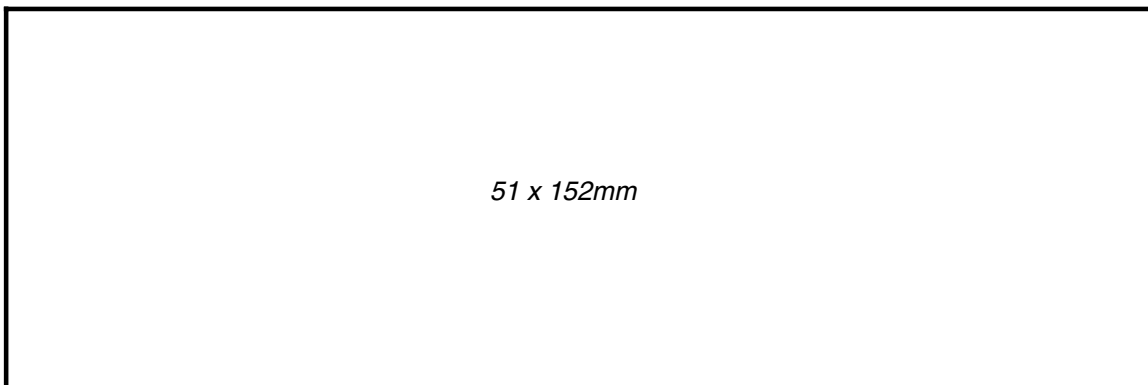
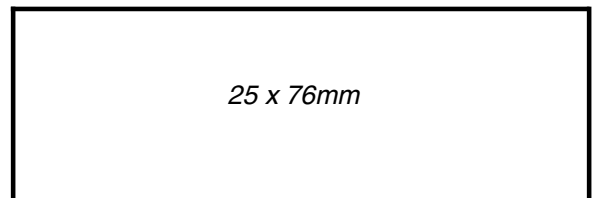
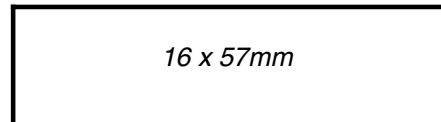
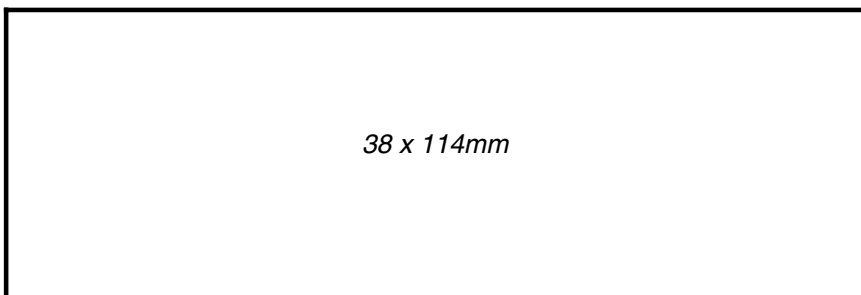









## Etikettengrößen

















For use in  
**Minolta**  
Copiers

**Central/Eastern Europe**  
Telephone: 31(0)183-696969  
Fax: 31(0)183-629055  
E-mail: order@edc.katun.com

OEM PN	KATUN PN	DESCRIPTION	MODEL NO.
<b>Bearings/Bushings</b>			
1300-4342-03	35576118 	<b>Bearing</b> Various Applications	CF 80, Di 520, Di 620, EP 310, EP 450, EP 450 Z, EP 490 Z, EP 510, EP 550 Z, EP 570 Z, EP 650 Z, EP 850, EP 870, EP 4230, EP 4232, EP 4250, EP 4320, EP 5400, EP 6000, EP 6001, EP 8010, EP 8015, EP 8600, EP 8601, EP 8602, EP 8605, EP 9765
1300-4344-03	35576205 	<b>Bearing</b> Various Applications  Lower Fuser Roller	CF 80, EP 470 Z, EP 490 Z, EP 550 Z, EP 570 Z, EP 710, EP 850, EP 870, EP 4232, EP 4250, EP 4320, EP 5325, EP 5400, EP 5425, EP 8600, EP 8601, EP 8602  EP 300, EP 300 RE, EP 370, EP 370 Z, EP 410 S, EP 410 Z, EP 415 Z, EP 425 Z, EP 4230, EP 4233, EP 4300
1300-4394-05	35576107 	<b>Bearing</b> Various Applications Lower Fuser Roller	CF 80, EP 550 Z, EP 650 Z EP 450, EP 450 Z
1300-4342-04	35576118 	<b>Bearing</b> Various Applications	CF 80, EP 850, EP 870, EP 8600, EP 8601, EP 8602, EP 8605
1300-4394-28	35576225 	<b>Upper Fuser Roller Bearing</b>	CF 80, EP 8010, EP 8600, EP 8601, EP 8602, EP 8605, EP 9765
1144-5752-01	35576209 	<b>Fuser Roller Bearing</b>	CF 900, CF 910
1300-4342-07	35576233 	<b>Bearing</b> Various Applications	CF 900, CF 910, CF 1501, CF 2001, CF 2002, CF 3102, CF 9001, Di 450, Di 470, Di 550, EP 6000, EP 6001, EP 8010, EP 8015, EP 9765, AF- 3, AF- 5, AFR- 7, AFR- 9, AFR- 12, AFR- 13, AFR- 14, AFR- 16, AFR- 17, AFR- 1000, EDH- 1, FN- 107, FN- 108, FN- 109, FN- 110, S- 10 VI, S- 20 III, S- 20 IV, S- 20 V, S- 20 VI, S- 202
50331060	35576233 	<b>Bearing</b>	CF 1501
26NA53710	35021630 	<b>Upper Fuser Roller Bearing</b>	CF 5001
4969-1043-01	35021630 	<b>Lower Fuser Roller Bearing</b>	CF 5001
4014-1747-01	35576216 	<b>Upper Fuser Roller Bearing</b>	CF 5001, Di 551, Di 650, Di 750, Di 850, DI 5510, DI 7210
4014-3007-01	35014269 	<b>Heat Insulating Sleeve</b> Various Applications Upper	Di 850 CF 5001, Di 551, Di 650, Di 750, DI 5510, DI 7210

*Priced per Heat Sleeve,  
sold in Bags of 10.*





















OEM PN	KATUN PN	DESCRIPTION	MODEL NO.
<b>Bearings/Bushings</b>			
4014-1780-01	35576233 	<b>Bearing</b> Various Applications Various Applications	C- 305, C- 305 L, C- 403, C- 404, EDH- 4, FN- 104 CF 5001, Di 551, Di 650, Di 750, Di 850, FN- 6, FN- 112, FN- 113
4014-1022-01	35576205 	<b>Bearing</b>	CF 5001, Di 750, Di 850
1144-5752-02	35576209 	<b>Fuser Roller Bearing</b>	CF 9001
0966-5719-01	35576131 	<b>Upper Fuser Roller Bearing</b>	Di 30
1273-3516-01	35576118 	<b>Bearing</b>	Di 30, Di 450, Di 470, Di 520, Di 550, Di 620, EP 1080, EP 1081, EP 2050, EP 3050, EP 4000, EP 4050, EP 4210, EP 4232, EP 4233, EP 5000, EP 5325, EP 5425, EP 6000, EP 6001, EP 8015, AD- 3, AD- 5, AD- 8, AD- 9, AF- 5, AFR- 7, AFR- 9, AFR- 12, AFR- 13, AFR- 14, AFR- 16, AFR- 17, AFR- 1000, PF- 4D, PF- 5D, PF- 7D, PF- 102, PF- 104, PF- 105, PF- 114, PF- 115, PF- 202, PF- 204, PF- 205, PF- 207, PF- 208
1067-5705-01	35015954 	<b>Lower Fuser Roller Bearing</b>	Di 30, EP 2120, EP 2121, EP 2130, EP 2131, EP 2150, EP 2151, EP 2152, EP 2153
1151-5610-02	35018044 	<b>Upper Fuser Roller Bushing</b>	Di 181, Di 250, Di 250 f, Di 350, EP 1052, EP 1054, EP 1083, EP 1085, EP 2010, EP 2030
1065-5871-01	35576118 	<b>Lower Fuser Roller Bearing</b>	Di 181, EP 1050, EP 1052, EP 1054, EP 1080, EP 1081, EP 1083, EP 1085, EP 2010, EP 2030, EP 2050, EP 2051, EP 2080, EP 3010, EP 3170, EP 4210, EP 4211
4011-5762-01	35576217 	<b>Upper Fuser Roller Bearing</b>	Di 200 f, Di 251, DI 251 F, Di 351, DI 351 F
1165-5712-01	35021630 	<b>Upper Fuser Roller Bearing</b>	Di 250, Di 350, Di 350 f
4002-5705-01	35576216 	<b>Upper Fuser Roller Bearing</b>	Di 450, Di 470, Di 550
4002-5778-01	35576233 	<b>Bearing</b>	Di 450, Di 470, Di 550
1300-4394-26	35576131 	<b>Fuser Roller Bearing</b> Lower  Upper	Di 520, Di 620, EP 650 Z, EP 850, EP 870, EP 6000, EP 6001, EP 8015, EP 8600, EP 8601, EP 8602, EP 8605, EP 9765 EP 370, EP 370 Z, EP 410 S, EP 410 Z, EP 415 Z, EP 425 Z, EP 4230, EP 4232, EP 4233, EP 4250, EP 4300
1075-5771-01	35576216 	<b>Upper Fuser Roller Bearing</b>	Di 520, Di 620, EP 6000, EP 6001, EP 8015

*Priced per Bushing,  
 sold in Bags of 4.*









For use in  
**Minolta**  
Copiers

**Central/Eastern Europe**  
Telephone: 31(0)183-696969  
Fax: 31(0)183-629055  
E-mail: order@edc.katun.com

OEM PN	KATUN PN	DESCRIPTION	MODEL NO.
<b>Bearings/Bushings</b>			
1075-5772-01	35021818 	<b>Heat Insulating Sleeve</b>	Di 520, Di 620, EP 6000, EP 6001, EP 8015
			<i>Priced per Bushing, sold in Bags of 2.</i>
4024-2005-01	35021522 	<b>Lower Fuser Roller Bearing</b>	Di 551, Di 650, DI 5510, DI 7210
4014-1719-01	35576205 	<b>Bearing</b>	Di 750, Di 850
4014-1727-01	35576118 	<b>Bearing</b>	Di 750, Di 850
4014-1748-01	35576204 	<b>Bearing</b>	Di 750, Di 850
4014-1766-01	35576233 	<b>Bearing</b>	Di 750, Di 850
4014-1827-01	35576203 	<b>Bearing</b>	Di 750, Di 850
4014-3006-01	35016005 	<b>Bearing</b> Fuser Auxiliary Roller	Di 750, Di 850
4014-1013-01	35576233 	<b>Bearing</b>	Di 750, Di 850, FN- 4, FN- 7, FN- 104, FN- 115, TMG- 2
4014-1034-01	35576118 	<b>Bearing</b>	Di 750, Di 850, FN- 7, FN- 115
1300-4344-05	35576205 	<b>Lower Fuser Roller Bearing</b>	EP 270, EP 350, EP 350 Z
0721-3757-01	35576131 	<b>Upper Fuser Roller Bearing</b>	EP 300, EP 300 RE, EP 310, EP 320
0721-0248-02	35576205 	<b>Lower Fuser Roller Bearing</b>	EP 310, EP 320
1300-4394-27	35576203 	<b>Upper Fuser Roller Bearing</b>	EP 450, EP 450 Z, EP 470 Z, EP 490 Z, EP 550 Z, EP 570 Z
1300-4394-13	35576221 	<b>Lower Fuser Roller Bearing</b>	EP 550 Z
1300-4394-03	35576131 	<b>Lower Fuser Roller Bearing</b>	EP 650 Z
1300-4394-22	35576225 	<b>Upper Fuser Roller Bearing</b>	EP 850, EP 870, EP 2050, EP 3050, EP 4000, EP 4050, EP 5000
1079-5523-02	35014328 	<b>Upper Fuser Roller Bushing</b> Various Applications Rear	EP 2050, EP 3050, EP 4050 EP 4000, EP 5000
			<i>Priced per Bushing, sold in Bags of 10.</i>
N/P/N	35014329 	<b>Upper Fuser Roller Bearing Kit</b> Kit Contains: • (2) Upper Fuser Roller Bushing • (2) Upper Fuser Roller Bearing	EP 2050, EP 3050, EP 4000, EP 4050, EP 5000







OEM PN	KATUN PN	DESCRIPTION	MODEL NO.
<b>Bearings/Bushings</b>			
1300-4394-29	35576221 	<b>Lower Fuser Roller Bearing</b>	EP 3050, EP 4000, EP 4050, EP 4320, EP 5325, EP 5400, EP 5425
1136-5813-01	35014328 	<b>Heat Insulating Sleeve</b> Various Applications Front	EP 3050, EP 4050 EP 4000, EP 5000
1300-4394-30	35576203 	<b>Upper Fuser Roller Bearing</b>	EP 4320, EP 5325, EP 5400, EP 5425
1145-5804-01	35576203 	<b>Lower Fuser Roller Bearing</b>	EP 8010
1203-5009-01	35576233 	<b>Bearing</b> Various Applications	AFR- 1, AFR- 2, F- 11, F- 12
1495-5120-01	35576118 	<b>Bearing</b>	F- 10















*Priced per Bushing,  
 sold in Bags of 10.*

For use in  
**Minolta**  
Copiers

**Central/Eastern Europe**  
Telephone: 31(0)183-696969  
Fax: 31(0)183-629055  
E-mail: [order@edc.katun.com](mailto:order@edc.katun.com)













OEM PN	KATUN PN	DESCRIPTION	MODEL NO.
<b>Belts</b>			
1266-5408-01	35018573 	<b>Original Document Feed Belt</b>	AF- 1
1284-3511-01	35011916 	<b>Original Document Feed Belt</b>	AF- 2, AFR- 2, AFR- 3, AFR- 4, AFR- 5, AFR- 6
1279-3507-01	35011916 	<b>Original Document Feed Belt</b>	AF- 2, AFR- 3, AFR- 4, AFR- 5
4433-3513-01	35011916 	<b>Original Document Feed Belt</b>	AF- 3
4426-5501-02	35014361 	<b>Original Document Feed Belt</b>	AF- 5, AFR- 7, AFR- 9, AFR- 10, AFR- 12, AFR- 13, AFR- 1000













OEM PN	KATUN PN	DESCRIPTION	MODEL NO.
<b>Blades/Brushes</b>			
1144-5513-02	35018830 	<b>Drum Cleaning Blade</b>	CF 900, CF 910, CF 9001
1013-5524-01	35012855 	<b>Toner Anti-Spill Blade</b>	Di 30, Di 450, Di 470, Di 550, EP 2050, EP 3050, EP 4000, EP 4050, EP 5000
4021-5622-01	35021876 	<b>Drum Cleaning Blade</b>	Di 152, Di 152 f, Di 183, Di 183 f
4163-5602-02	35021876 	<b>Drum Cleaning Blade</b>	Di 152, Di 183
1139-5711-17	35012908 	<b>Drum Cleaning Blade</b> New OEM style blade. Note: Shoulder screws (OEM PN 1130-5710-02 and 1139-5713-01) may be required for unmodified EP 1080/1081 PPC's. See Minolta Service Bulletin EP 1080-034	Di 181, EP 1050, EP 1052, EP 1054, EP 1080, EP 1081, EP 1083, EP 1085, EP 2010, EP 2030, EP 2051, EP 2080, EP 3010
1139-5711-17	35022574	<b>Drum Cleaning Blade Access By Katun</b>	Di 181, EP 1050, EP 1052, EP 1054, EP 1080, EP 1081, EP 1083, EP 1085, EP 2010, EP 2030, EP 2051, EP 2080, EP 3010
1139-5726-01	35012566 	<b>Toner Anti-Spill Blade</b>	Di 181, EP 1052, EP 1054, EP 1080, EP 1081, EP 1083, EP 1085, EP 2010, EP 2030, EP 2051, EP 2080, EP 3010
N/P/N	35021712 	<b>Drum Cleaning Blade</b>	Di 200 f, Di 250, Di 250 f, Di 251, DI 251 F, Di 350, Di 350 f, Di 351, DI 351 F
1136-0901-01	35017020 	<b>Drum Cleaning Blade Kit</b>	Di 450, Di 470, Di 550, EP 2050, EP 3050, EP 4000, EP 4050, EP 5000
1074-0156-01	35014741 	<b>Toner Anti-Spill Blade</b>	Di 520, Di 620, EP 6000, EP 6001, EP 8010, EP 8015, EP 9765
1074-0904-01	35010547 	<b>Drum Cleaning Blade Kit</b>	Di 520, Di 620, EP 8010, EP 9765
4024-1004-01	35021874 	<b>Drum Cleaning Blade</b>	Di 551, Di 650, DI 5510, DI 7210
4014-3021-01	35019787 	<b>Drum Cleaning Blade</b>	Di 750
4014-3032-01 <i>Final Inventory</i>	35021534 	<b>Toner Guide Brush Assembly</b>	Di 750, Di 850
4027-1359-01	35019787 	<b>Drum Cleaning Blade</b>	Di 850
1036-5505-03	35000995 	<b>Toner Anti-Spill Blade</b>	EP 370, EP 370 Z, EP 410 S, EP 410 Z

For use in  
**Minolta**  
Copiers

**Central/Eastern Europe**  
Telephone: 31(0)183-696969  
Fax: 31(0)183-629055  
E-mail: order@edc.katun.com





OEM PN	KATUN PN	DESCRIPTION	MODEL NO.
<b>Blades/Brushes</b>			
1036-0105-02	35243462 	<b>Drum Cleaning Blade</b>	EP 370, EP 370 Z, EP 410 S, EP 410 Z, EP 415 Z
1043-5505-01	35000995 	<b>Toner Anti-Spill Blade</b>	EP 415 Z, EP 425 Z, EP 4300
1049-0105-01	35012882	<b>Drum Cleaning Blade Access By Katun</b>	EP 425 Z, EP 3170, EP 4210, EP 4211, EP 4230, EP 4232, EP 4233, EP 4250
1053-0149-01	35012882	<b>Drum Cleaning Blade Access By Katun</b>	EP 425 Z, EP 3170, EP 4210, EP 4211, EP 4230, EP 4232, EP 4233, EP 4250, EP 4300, EP 4320, EP 5325, EP 5400, EP 5425
1021-0102-02	35243478 	<b>Drum Cleaning Blade</b>	EP 450, EP 450 Z
1033-0151-12	35244599 	<b>Drum Cleaning Blade</b>	EP 470 Z
1051-0160-01	35243427 	<b>Drum Cleaning Blade</b>	EP 850, EP 870, EP 8600, EP 8601, EP 8602
1159-0755-01	35019181 	<b>Drum Cleaning Blade</b>	EP 1030, EP 1030 F, EP 1031, EP 1031 F
1050-5511-12	35243416 	<b>Drum Cleaning Blade</b>	EP 2100, EP 3120, EP 3150
1132-5543-01	35010398 	<b>Drum Cleaning Blade</b> For Use in New Style Imaging Units	EP 2120, EP 2121, EP 2130, EP 2131, EP 2150, EP 2151, EP 2152, EP 2153
1067-5501-01	35009601 	<b>Drum Cleaning Blade</b> For Use in Old Style Imaging Units	EP 2120, EP 2121, EP 2150, EP 2151
1054-5524-02	35012939 	<b>Toner Anti-Spill Blade</b>	EP 3170, EP 4210, EP 4211, EP 4230, EP 4232, EP 4233, EP 4250, EP 4320, EP 5325, EP 5400, EP 5425
1075-0902-01	35014426 	<b>Drum Cleaning Blade Kit</b> Blade only	EP 6000, EP 6001, EP 8015
1074-0155-02	35010547 	<b>Drum Cleaning Blade</b>	EP 8010, EP 9765
1140-0901-01	35012011 	<b>Drum Cleaning Blade</b>	EP 8605











OEM PN	KATUN PN	DESCRIPTION	MODEL NO.
<b>Corona/Charge/Transfer</b>			
1074-0161-01	35375208 	<b>Corona Wire</b> 60μ 0.3μ Gold Plated Pretransfer	CF 900, CF 910, CF 9001, EP 8010, EP 9765  <i>Priced per Set, 10 Corona Wires per Set.</i>
1033-0753-01	35375208 	<b>Corona Wire</b> 60μ 0.3μ Gold Plated All Applications	Di 30, EP 470 Z, EP 490 Z, EP 570 Z  <i>Priced per Set, 10 Corona Wires per Set.</i>
1079-0760-01	35013989 	<b>Corona Wire</b> 50μ Oxidized All Applications Charge	Di 30, EP 4210, EP 4211 EP 3050, EP 4050, EP 4320, EP 5325, EP 5400, EP 5425  <i>Priced per Set, 10 Corona Wires per Set.</i>
1075-0765-01	35013999 	<b>Corona Wire</b> Cleaning Pads not included. 60μ 0.3μ Gold Plated Various Applications All Applications	Di 181, Di 450, Di 470, Di 550 EP 6000  <i>Priced per Set, 10 Corona Wires per Set.</i>
1161-4053-01	35017503 	<b>Corona Plate</b>	Di 520, Di 620, EP 6001, EP 8015
4024-1010-01	35023038 	<b>Corona Wire</b> 60μ Oxidized Discharge	Di 551, Di 650, DI 5510, DI 7210
4024-1020-01	35023037 	<b>Corona Wire</b> 60μ 3.0u Gold Plated Charge	Di 551, Di 650, DI 5510, DI 7210
4014-3010-02	35019922 	<b>Corona Wire</b> 60μ 1.5μ Gold Plated Charge	Di 750
4014-3010-02	35019923 	<b>Corona Wire</b> 60μ 1.5μ Gold Plated Charge	Di 750  <i>Priced per Corona Wire, sold in Bags of 10.</i>
4014-3009-01	35021637 	<b>Charge Corona Grid</b>	Di 750, Di 850

For use in  
**Minolta**  
Copiers

**Central/Eastern Europe**  
Telephone: 31(0)183-696969  
Fax: 31(0)183-629055  
E-mail: order@edc.katun.com

OEM PN	KATUN PN	DESCRIPTION	MODEL NO.
<b>Corona/Charge/Transfer</b>			
N/P/N	35375527 	<b>Corona Wire Spool</b> 50 m / Spool Increased plating thickness enhances corona wire life. 60μ 1.5μ Gold Plated All Applications	EP 270, EP 350, EP 350 Z, EP 370, EP 370 Z, EP 470 Z, EP 490 Z, EP 570 Z, EP 650 Z, EP 850, EP 870, EP 8600, EP 8601, EP 8602, EP 8605
N/P/N	35375120 	<b>Corona Wire Spool</b> 50 m / Spool 60μ 0.3μ Gold Plated All Applications	EP 270, EP 350, EP 350 Z, EP 370, EP 370 Z, EP 470 Z, EP 490 Z, EP 570 Z, EP 650 Z, EP 850, EP 870, EP 8600, EP 8601, EP 8602, EP 8605
N/P/N	35375528 	<b>Corona Wire Spool</b> 50 m / Spool Increased plating thickness enhances corona wire life. 100μ 1.5μ Gold Plated Separation	EP 300, EP 300 RE, EP 310, EP 320, EP 450, EP 450 Z
N/P/N	35375121 	<b>Corona Wire Spool</b> 50 m / Spool 100μ 0.3μ Gold Plated Separation	EP 300, EP 300 RE, EP 310, EP 320, EP 450, EP 450 Z
N/P/N	35375549 	<b>Corona Wire Spool</b> 50 m / Spool 100μ Stainless Steel Separation	EP 300, EP 300 RE, EP 310, EP 320, EP 450, EP 450 Z
1189002-010	35375120 	<b>Corona Wire Spool</b> 50 m / Spool 60μ 0.3μ Gold Plated Transfer, Separation	EP 303 W
1189075-010	35375121 	<b>Grid Wire Spool</b> 50 m / Spool 100μ 0.3μ Gold Plated	EP 303 W



OEM PN	KATUN PN	DESCRIPTION	MODEL NO.
<b>Corona/Charge/Transfer</b>			
1189077-010	35375527 	<b>Corona Wire Spool</b> 50 m / Spool Increased plating thickness enhances corona wire life. 60μ 1.5μ Gold Plated Charge	EP 303 W
N/P/N	35375228 	<b>Corona Wire Spool</b> Platinum alloy clad technology extends corona wire life. 60μ 7.5 m / Spool All Applications	EP 350, EP 350 Z, EP 570 Z, EP 650 Z, EP 850, EP 870, EP 8600, EP 8601, EP 8602
1031-0751-01	35375208 	<b>Corona Wire</b> 60μ 0.3μ Gold Plated All Applications Transfer, Separation	EP 850, EP 870 EP 8600, EP 8601, EP 8602, EP 8605
1139-0756-01	35012569 	<b>Corona Wire</b> 50μ Oxidized Transfer, Separation	EP 1052, EP 1054, EP 1080, EP 1081, EP 1083, EP 1085, EP 2010, EP 2030, EP 2051, EP 2080, EP 3010, EP 3050, EP 4000, EP 4050, EP 5000 EP 2050
1139-4261-01	35016697 	<b>Charge Corona Grid</b>	EP 1052, EP 1054, EP 1080, EP 1081, EP 1083, EP 1085, EP 2010, EP 2030, EP 2051, EP 2080, EP 3010, EP 4000, EP 5000
1067-0759-01	35013991 	<b>Corona Wire</b> 50μ Oxidized Charge, Transfer	EP 2120, EP 2121, EP 2130, EP 2131, EP 2150, EP 2151, EP 2152, EP 2153
1054-0751-01	35375159 	<b>Corona Wire</b> 50μ Polished All Applications Charge	EP 3170, EP 4210, EP 4211, EP 4230, EP 4232, EP 4233, EP 4250 EP 4320
1052-0752-01 <i>Final Inventory</i>	35375160 	<b>Corona Wire</b> 50μ Polished Transfer, Separation	EP 4320
1075-4058-01	35016696 	<b>Charge Corona Grid</b>	EP 6000

*Priced per Set,  
10 Corona Wires per Set.*

*Priced per Set,  
10 Corona Wires per Set.*

*Priced per Set,  
10 Corona Wires per Set.*

*Priced per Set,  
10 Corona Wires per Set.*

*Priced per Set,  
10 Corona Wires per Set.*

For use in  
**Minolta**  
 Copiers

**Central/Eastern Europe**  
 Telephone: 31(0)183-696969  
 Fax: 31(0)183-629055  
 E-mail: order@edc.katun.com

OEM PN	KATUN PN	DESCRIPTION	MODEL NO.
<b>Developers</b>			
8936-418	35022491	<b>Black Developer Original</b> 200 g / Bag	Di 152, Di 183, DI 1611, DI 2011
8931-412	35013593	<b>Black Developer Original</b> 400 g / Bag	EP 370, EP 370 Z, EP 425 Z, EP 3170, EP 4210, EP 4211, EP 4230, EP 4232, EP 4233, EP 4250, EP 4300
8936-214	35019606	<b>Black Developer Original</b> 350 g / Bottle	EP 1054, EP 1085, EP 2030, EP 3010



Central/Eastern Europe  
Telephone: 31(0)183-696969  
Fax: 31(0)183-629055  
E-mail: order@edc.katun.com

For use in  
**Minolta**  
Copiers













OEM PN	KATUN PN	DESCRIPTION	MODEL NO.
-----------	-------------	-------------	--------------

## Electrical

N/P/N	35010515 	Imaging Unit Fuse	Di 200 f, Di 250, Di 250 f, Di 251, DI 251 F, Di 350, Di 350 f, Di 351, DI 351 F, EP 2120, EP 2121, EP 2130, EP 2131, EP 2150, EP 2151, EP 2152, EP 2153	<i>Priced per Bag, 20 Fuses per Bag.</i>
-------	---	-------------------	---	--

For use in  
**Minolta**  
Copiers

**Central/Eastern Europe**  
Telephone: 31(0)183-696969  
Fax: 31(0)183-629055  
E-mail: order@edc.katun.com







OEM PN	KATUN PN	DESCRIPTION	MODEL NO.	
<b>Feed/Delivery</b>				
1052-5222-01	35009692 	<b>Paper Pickup Roller</b> Tire Only	CF 80, EP 4320, EP 5400	<i>Priced per Tire, sold in Bags of 10.</i>
4024-2058-01	35016677 	<b>Double Feed Prevention Tire</b> Tire Only	CF 5001, Di 551, Di 650, DI 5510, DI 7210	<i>Priced per Tire, sold in Bags of 8.</i>
4002-3216-01	35021951 	<b>Paper Feed Roller</b>	Di 181, Di 450, Di 470, Di 520, Di 550, Di 620, EP 1054, EP 1080, EP 1083, EP 1085, EP 2000, EP 2010, EP 2030, EP 2050, EP 2051, EP 2080, EP 3010, EP 3050, EP 4000, EP 4050, EP 4320, EP 5000, EP 5400, EP 6000, EP 6001, EP 8015, AD- 3, AD- 8, AD- 9, AD- 11, C- 402, MB- 4, PF- 4D, PF- 5D, PF- 6D, PF- 102, PF- 104, PF- 105, PF- 112, PF- 114, PF- 115, PF- 201, PF- 202, PF- 204, PF- 205, PF- 206, PF- 207, PF- 208, T- 312	<i>Priced per Feed/Sep Roller, sold in Bags of 2.</i>
1151-3001-01	35013777 	<b>Paper Feed Roller</b> Tire Only	Di 181, EP 1052, EP 1054, EP 1083, EP 1085, EP 2010, EP 2030, EP 2051	<i>Priced per Tire, sold in Bags of 10.</i>
4425-3009-01	35000878 	<b>Paper Feed Roller</b> Tire Only	Di 181, EP 2050, EP 2080, EP 3010, EP 3050, EP 4000, EP 4050, EP 5000, AD- 3, AD- 5, AD- 8, AD- 9, AD- 11, PF- 4D, PF- 5D, PF- 102, PF- 104, PF- 105, PF- 112, PF- 114, PF- 201, PF- 202, PF- 204, PF- 205, PF- 207	<i>Priced per Tire, sold in Bags of 10.</i>
1164-3001-01	35021894 	<b>Takeup Roller</b> Tire Only	Di 200 f, Di 250, Di 250 f, Di 251, DI 251 F, Di 350, Di 350 f, Di 351, DI 351 F	<i>Priced per Tire, sold in Bags of 3.</i>
4002-3201-01	35022052 	<b>Paper Pickup Roller</b> Tire Only	Di 450, Di 470, Di 550, PF- 115, PF- 208	<i>Priced per Tire, sold in Bags of 10.</i>
1075-3051-01	35013024 	<b>Paper Pickup/Feed Roller</b> Tire Only	Di 520, Di 620, EP 6000, EP 6001, EP 8015, C- 301, C- 302, C- 303, C- 304, C- 304 L	<i>Priced per Tire, sold in Bags of 10.</i>
4024-1030-01	35015378 	<b>Paper Feed Tire</b> Tire Only	Di 551, Di 650, DI 5510, DI 7210	<i>Priced per Tire, sold in Bags of 10.</i>
4014-3028-01	35019940 	<b>Feed/Double Feed Prevention Roller Assy</b> Tire Only	Di 750, Di 850, C- 305, C- 305 L, C- 403, C- 404	<i>Priced per Tire, sold in Bags of 10.</i>
4014-3029-01	35019941 	<b>Paper Feed Roller Assembly</b>	Di 750, Di 850, C- 305, C- 305 L, C- 403, C- 404	<i>Priced per Feed/Sep Roller, sold in Bags of 10.</i>
1231-5402-02	35011312 	<b>Paper Feed Roller</b> Tire Only	EP 425 Z, AD- 1, AD- 2, C- 500 3, C- 500 3A, T- 302, T- 303, T- 312	<i>Priced per Tire, sold in Bags of 5.</i>







OEM PN	KATUN PN	DESCRIPTION	MODEL NO.	
<b>Feed/Delivery</b>				
1051-5401-01	35012218 	<b>Takeup Roller</b> Tire Only Ribbed Tire	EP 850, EP 870, EP 8010, EP 8600, EP 8601, EP 8602, EP 8605, EP 9765, C- 202, C- 2000 A	<i>Priced per Tire, sold in Bags of 5.</i>
1031-5402-02	35011546 	<b>Paper Feed Roller</b> Tire Only	EP 850, EP 870, EP 8010, EP 8600, EP 8601, EP 8605, EP 9765, C- 202, C- 205, C- 2000 A	<i>Priced per Tire, sold in Bags of 5.</i>
1139-3001-01	35013777 	<b>Paper Pickup Roller</b> Tire Only	EP 1080, EP 1081, EP 2050	<i>Priced per Tire, sold in Bags of 10.</i>
1067-3001-02	35014019 	<b>Paper Pickup Roller</b> Tire Only	EP 2120, EP 2121, EP 2130, EP 2131, EP 2150, EP 2151, EP 2152, EP 2153	<i>Priced per Tire, sold in Bags of 10.</i>
1065-3061-01	35009692 	<b>Paper Pickup Roller</b> Tire Only	EP 3170, EP 4210, EP 4211, EP 4233, EP 5325, EP 5425	<i>Priced per Tire, sold in Bags of 10.</i>
1054-5428-01	35011094 	<b>Paper Feed Roller</b> OEM uses Urethane Material	EP 4230	
1054-5401-01	35011094 	<b>Paper Pickup Roller</b> OEM uses Urethane Material	EP 4230, EP 4232, EP 4250	
1052-5223-01	35018480 	<b>Separation Roller</b> Tire Only	EP 4233, EP 4320, EP 5400	<i>Priced per Tire, sold in Bags of 10.</i>
1053-5402-01	35011093 	<b>Paper Feed Roller</b>	EP 4300	
1261-5402-02	35010188 	<b>Paper Feed Roller</b> Tire Only	EP 8010, EP 9765, AFR- 1, RDH- 1	<i>Priced per Tire, sold in Bags of 4.</i>
1259-5401-03	35011373 	<b>Separation Roller</b> Tire Only	AF- 1, AFR- 2, C- 201, C- 203	<i>Priced per Tire, sold in Bags of 10.</i>
1259-5402-04	35011373 	<b>Paper Feed Roller</b> Tire Only	AF- 1, AFR- 2, C- 201, C- 203, C- 204, C- 401, T- 301	<i>Priced per Tire, sold in Bags of 10.</i>
4433-3023-01	35015555 	<b>Original Pickup Roller</b> Tire Only	AF- 3	<i>Priced per Pickup Roller, sold in Bags of 5.</i>
4474-0217-04	35021495 	<b>Separation Pad</b> "Pad only"	AF- 5, AFR- 12	<i>Priced per Separation Pad, sold in Bags of 10.</i>
4474-3505-01	35016970 	<b>Original Pickup Roller</b> Tire Only	AF- 5, AFR- 12	<i>Priced per Tire, sold in Bags of 4.</i>
4474-3506-01	35021752 	<b>Original Pickup Roller</b>	AF- 5, AFR- 12	

For use in  
**Minolta**  
Copiers

**Central/Eastern Europe**  
Telephone: 31(0)183-696969  
Fax: 31(0)183-629055  
E-mail: order@edc.katun.com

OEM PN	KATUN PN	DESCRIPTION	MODEL NO.	
<b>Feed/Delivery</b>				
4434-0751-13	35021210 	<b>Separation Pad</b> "Pad only"	AFR- 6, AFR- 8	<i>Priced per Separation Pad, sold in Bags of 10.</i>
4408-0751-01	35021209 	<b>Separation Pad</b> "Pad only"	AFR- 7, AFR- 9, AFR- 13	<i>Priced per Separation Pad, sold in Bags of 10.</i>
4408-0751-01	35023916 	<b>Separation Pad</b>	AFR- 7, AFR- 9, AFR- 13	
4426-3128-02	35020979 	<b>Original Feed Roller</b>	AFR- 7, AFR- 9, AFR- 13, AFR- 1000	<i>Priced per Feed/Sep Roller, sold in Bags of 4.</i>
4426-3128-02	35011858 	<b>Original Feed Roller</b> Tire Only	AFR- 7, AFR- 9, AFR- 13, AFR- 1000	<i>Priced per Tire, sold in Bags of 4.</i>
4490-3504-01	35022790 	<b>Paper Feed Roller</b>	AFR- 14, AFR- 16, AFR- 17	<i>Priced per Feed/Sep Roller, sold in Bags of 2.</i>
4490-3505-02	35022624 	<b>Paper Takeup Roller</b>	AFR- 14, AFR- 16, AFR- 17	<i>Priced per Takeup Roller, sold in Bags of 2.</i>
4652-0752-01	35021477 	<b>Separation Pad</b> "Pad only"	AFR- 14, AFR- 16, AFR- 17	<i>Priced per Separation Pad, sold in Bags of 10.</i>
4014-1792-01	35020760 	<b>Torque Limiter</b>	C- 305, C- 305 L, C- 403, C- 404	
4014-1055-01	35022977 	<b>Exit Roller</b>	FN- 4, FN- 6, FN- 7, FN- 104, FN- 112, FN- 113, FN- 115	<i>Priced per Exit Roller, sold in Boxes of 2.</i>
4496-3001-02	35023398 	<b>Paper Feed Roller</b> Tire Only Ribbed Tire	PF- 106, PF- 117, PF- 121	<i>Priced per Tire, sold in Bags of 4.</i>
4496-3046-01	35023398 	<b>Paper Pickup Roller</b> Tire Only Ribbed Tire	PF- 117, PF- 121	<i>Priced per Tire, sold in Bags of 4.</i>



OEM PN	KATUN PN	DESCRIPTION	MODEL NO.
<b>Filters</b>			
1155-3611-01	35023034 	Vacuum Transport Ozone Filter	Di 520, Di 620
4014-1795-01	35018380 	Ozone Filter	Di 551, Di 650, Di 750, Di 850
4014-3014-01 <i>Final Inventory</i>	35021659 	Suction Filter	Di 750, Di 850
1134-4118-01	35012881 	Ozone Filter	EP 3050, EP 4050

For use in  
**Minolta**  
Copiers

**Central/Eastern Europe**  
Telephone: 31(0)183-696969  
Fax: 31(0)183-629055  
E-mail: order@edc.katun.com

OEM PN	KATUN PN	DESCRIPTION	MODEL NO.
<b>Fuser Cleaning</b>			
1061-5545-01	35017937	<b>Fuser Cleaning Roller</b>	CF 80, CF 900, CF 910, CF 9001
1144-5794-02	35018896	<b>Oil Pickup Roller</b>	CF 900, CF 910, CF 9001
1144-5797-01	35019439	<b>Oil Application Roller</b>	CF 900, CF 910, CF 9001
1144-5799-13	35018516	<b>Oil Supply Roller</b>	CF 900, CF 910, CF 9001
1174-5609-01	35022442	<b>Lower Fuser Cleaning Roller</b>	Di 181, EP 1054, EP 1085, EP 2030, EP 3010
1164-5762-01	35021665	<b>Fuser Cleaning Roller</b>	Di 250, Di 250 f, Di 350, Di 350 f
1075-5751-01	35023551	<b>Web Supply Pressure Roller</b>	Di 450, Di 470, Di 520, Di 550, Di 620, EP 6000, EP 6001, EP 8010, EP 8015
1145-5801-01	35014814	<b>Web Supply Roller</b>	Di 450, Di 470, Di 520, Di 550, Di 620, EP 6001, EP 8010, EP 8015
4002-5732-01	35014814	<b>Web Supply Roller</b>	Di 450, Di 550
1051-1716-01	35632305	<b>Oil Supply Roller</b> For use with mod. kit only.	Di 520, Di 620, EP 850, EP 870, EP 6000, EP 6001, EP 8015, EP 8600, EP 8601
4014-3019-01	35019598	<b>Lower Fuser Cleaning Roller</b>	Di 750
4014-3030-01	35019297	<b>Cleaning Web Assembly</b>	Di 750, Di 850
1036-1703-03	35632389	<b>Fuser Cleaning Roller</b>	EP 370, EP 370 Z, EP 410 S, EP 410 Z, EP 415 Z, EP 425 Z, EP 4300
1032-1701-01	35636727	<b>Wave Roller</b>	EP 490 Z, EP 570 Z, EP 4320, EP 5400
1051-1701-01	35632581	<b>Wave Roller</b> Cleaning Belt	EP 850, EP 870, EP 8600, EP 8601, EP 8602
1139-5525-01	35014054	<b>Oil Supply Roller</b>	EP 1050, EP 1052, EP 1080, EP 1081, EP 1083, EP 2010
1151-5609-01	35016366	<b>Lower Fuser Cleaning Roller</b>	EP 1052, EP 1083, EP 2010, EP 2051, EP 2080
1136-5782-02	35012581	<b>Oil Supply Roller FIBRA™ II</b> Enhanced fuser cleaning efficiency.	EP 2050, EP 2051, EP 2080, EP 3050, EP 4000, EP 4050, EP 5000
1050-1703-02	35000867	<b>Fuser Cleaning Roller</b>	EP 2100, EP 3120, EP 3150

*Priced per Bag,  
7 Cleaning Rollers per Bag.*









Katun Performance Product

© 2004 Katun Corporation

**13 September 2004** For the most current product and pricing information, visit the Katun On-Line Catalog at [www.katun.com](http://www.katun.com).

Prices, terms and conditions are subject to change without notice.

OEM PN	KATUN PN	DESCRIPTION	MODEL NO.
<b>Fuser Cleaning</b>			
1067-5729-02	35011281 	Fuser Cleaning Roller	EP 2120, EP 2121, EP 2150, EP 2151
1132-5729-01	35013217 	Fuser Cleaning Roller	EP 2130, EP 2131, EP 2152, EP 2153
1173-5782-02	35019609 	Fuser Cleaning Roller	EP 3010
1054-1702-01	35008781 	Oil Supply Roller	EP 3170, EP 4210, EP 4211, EP 4230, EP 4232, EP 4233, EP 4250
1076-5806-01	35636727 	Web Supply Roller	EP 5325, EP 5425
1074-5787-01	35012597 	Web Supply Roller	EP 6000, EP 8605, EP 9765







For use in  
**Minolta**  
Copiers

**Central/Eastern Europe**  
Telephone: 31(0)183-696969  
Fax: 31(0)183-629055  
E-mail: [order@edc.katun.com](mailto:order@edc.katun.com)

OEM PN	KATUN PN	DESCRIPTION	MODEL NO.
<b>Fuser Oil</b>			
8932-892	35019687 	<b>Fuser Oil</b> 1000 ml / Bottle	CF 900, CF 910, CF 9001

*Priced per Bottle,  
sold in Boxes of 6.*





OEM PN	KATUN PN	DESCRIPTION	MODEL NO.	
<b>Kits</b>				
N/P/N	35023543 	<b>Drum Cartridge Rebuild Kit</b> Kit Contains: • (1) OPC Drum • (1) Drum Cleaning Blade • (1) Black Toner • (1) Disposable Funnel 1 OPC Kit per Master Carton	Di 151, Di 151 f	<i>Priced per OPC Kit, sold per OPC Kit.</i>
N/P/N	35022691 	<b>Drum Cartridge Rebuild Kit</b> Kit Contains: • (1) OPC Drum • (1) Drum Cleaning Blade • (1) Black Developer • (1) Developer Foam Seal/Fuse 1 Kit per Master Carton	Di 200 f, Di 250, Di 250 f, Di 251, DI 251 F, Di 350, Di 350 f, Di 351, DI 351 F	<i>Priced per Kit, sold per Kit.</i>
N/P/N	35022845 	<b>Drum Cartridge Rebuild Kit</b> Kit Contains: • (1) OPC Drum • (1) Drum Cleaning Blade • (1) Developer Foam Seal/Fuse 1 Kit per Master Carton	Di 200 f, Di 250, Di 250 f, Di 251, DI 251 F, Di 350, Di 350 f, Di 351, DI 351 F	<i>Priced per Kit, sold per Kit.</i>
1136-0901-01	35017020 	<b>Drum Cleaning Blade Kit</b>	Di 450, Di 470, Di 550, EP 2050, EP 3050, EP 4000, EP 4050, EP 5000	
1074-0904-01	35010547 	<b>Drum Cleaning Blade Kit</b>	Di 520, Di 620, EP 8010, EP 9765	
N/P/N	35018506 	<b>Imaging Unit Rebuild Kit</b> Kit Contains: • (1) OPC Drum • (1) Drum Cleaning Blade • (2) Developer Spacer Roller • (1) Black Developer • (1) Bulk Fuses 1 OPC Kit per Master Carton	EP 1030, EP 1030 F, EP 1031, EP 1031 F	<i>Priced per OPC Kit, sold per OPC Kit.</i>
N/P/N	35014329 	<b>Upper Fuser Roller Bearing Kit</b> Kit Contains: • (2) Upper Fuser Roller Bushing • (2) Upper Fuser Roller Bearing	EP 2050, EP 3050, EP 4000, EP 4050, EP 5000	

For use in  
**Minolta**  
 Copiers













**Central/Eastern Europe**  
 Telephone: 31(0)183-696969  
 Fax: 31(0)183-629055  
 E-mail: order@edc.katun.com

OEM PN	KATUN PN	DESCRIPTION	MODEL NO.
--------	----------	-------------	-----------

### Kits









N/P/N	35010456 	<b>Imaging Unit Rebuild Kit</b> For rebuilding the "new" style IU. OEM Part Number 4436-200 Kit Contains: <ul style="list-style-type: none"> <li>• (2) Precut Corona Wire</li> <li>• (1) Bulk Fuses</li> <li>• (1) OPC Drum</li> <li>• (1) Black Developer</li> <li>• (1) Drum Cleaning Blade</li> <li>• (2) Developer Unit Seal A</li> </ul> 12 Kits per Master Carton	EP 2120, EP 2121, EP 2130, EP 2131, EP 2150, EP 2151, EP 2152, EP 2153	<i>Priced per Kit, sold per Kit.</i>
1075-0902-01	35014426 	<b>Drum Cleaning Blade Kit</b> Blade only	EP 6000, EP 6001, EP 8015	



OEM PN	KATUN PN	DESCRIPTION	MODEL NO.
<b>Lamps</b>			
9352-2001-21	35023040 	<b>Heater Lamp</b> 230V 800W	Di 251, DI 251 F, Di 351, DI 351 F
9352-2910-62	35023451 	<b>Upper Heater Lamp</b> 230V 1011W	Di 450, Di 550
9351-2221-01	35021179 	<b>Exposure Lamp</b> 160V 350W	EP 450, EP 450 Z
9351-2310-41	35014574 	<b>Exposure Lamp</b> 160V 240W	EP 1050, EP 1080, EP 1081
9351-2610-21	35021174 	<b>Exposure Lamp</b> 160V 240W	EP 1052, EP 1054, EP 1083, EP 1085, EP 2010, EP 2030
9351-2310-81	35016405 	<b>Exposure Lamp</b> 160V 250W	EP 2050, EP 3050, EP 4050
9352-2010-22	35021078 	<b>Heater Lamp</b> 220/240V 800W	EP 2120, EP 2121, EP 2130, EP 2131, EP 2150, EP 2151, EP 2152, EP 2153
1065-0761-01	35021079 	<b>Heater Lamp</b> 220/240V 900W	EP 3170, EP 4210, EP 4211
9351-2010-41	35021137 	<b>Exposure Lamp</b> 160V 260W	EP 3170, EP 4210, EP 4211
9351-2821-01	35021154 	<b>Exposure Lamp</b> 160V 280W	EP 4230, EP 4232, EP 4250
9351-2821-52	35021125 	<b>Exposure Lamp</b> 162V 235W	EP 4320, EP 5325, EP 5400, EP 5425
9351-2311-01	35014703 	<b>Exposure Lamp</b> 160V 250W	EP 6000, EP 6001











For use in  
**Minolta**  
 Copiers

**Central/Eastern Europe**  
 Telephone: 31(0)183-696969  
 Fax: 31(0)183-629055  
 E-mail: order@edc.katun.com

OEM PN	KATUN PN	DESCRIPTION	MODEL NO.
<b>Memory Upgrades</b>			
7640-0001-10	35019995 	<b>Memory Upgrade Board- 64 MB</b> Printer Memory Upgrade	Di 551, Di 650, PI- 6500
7640-0001-11	35019996 	<b>Memory Upgrade Board-128 MB</b> Printer Memory Upgrade	Di 551, Di 650, PI- 6500
4179-461	35018398 	<b>Hard Drive Upgrade Kit</b> Printer Hard Drive	Pi- 3500
N/P/N	35018397 	<b>Memory Upgrade Board- 64 MB</b> Controller Memory	Pi- 3500
N/P/N	35018395 	<b>Memory Upgrade Board- 16 MB</b> Controller Memory	Pi- 3500
N/P/N	35018396 	<b>Memory Upgrade Board- 32 MB</b> Controller Memory	Pi- 3500
4499-6601-01	35018401 	<b>Memory Upgrade Board- 16 MB</b> Controller Memory	Pi- 6000
N/P/N	35018402 	<b>Memory Upgrade Board- 32 MB</b> Controller Memory	Pi- 6000

For current memory upgrade pricing, visit our on-line catalogue at [www.katun.com](http://www.katun.com) or contact your customer service representative.









OEM PN	KATUN PN	DESCRIPTION	MODEL NO.	
<b>Photoreceptors</b>				
1144-0294	35022274 	<b>OPC Drum</b> 6 Drums per Master Carton	CF 900, CF 910	<i>Priced per Drum, sold per Drum.</i>
1179-0297-01	35022274 	<b>OPC Drum</b> 6 Drums per Master Carton	CF 9001	<i>Priced per Drum, sold per Drum.</i>
N/P/N	35023543 	<b>Drum Cartridge Rebuild Kit</b> Kit Contains: • (1) OPC Drum • (1) Drum Cleaning Blade • (1) Black Toner • (1) Disposable Funnel 1 OPC Kit per Master Carton	Di 151, Di 151 f	<i>Priced per OPC Kit, sold per OPC Kit.</i>
4021-0292-01	35023076 	<b>OPC Drum</b> 20 Drums per Master Carton	Di 152, Di 183, DI 1611, DI 2011	<i>Priced per Drum, sold per Drum.</i>
1177-0292	35018890 	<b>OPC Drum</b> 12 Drums per Master Carton	Di 181	<i>Priced per Drum, sold per Drum.</i>
N/P/N	35022691 	<b>Drum Cartridge Rebuild Kit</b> Kit Contains: • (1) OPC Drum • (1) Drum Cleaning Blade • (1) Black Developer • (1) Developer Foam Seal/Fuse 1 Kit per Master Carton	Di 200 f, Di 250, Di 250 f, Di 251, DI 251 F, Di 350, Di 350 f, Di 351, DI 351 F	<i>Priced per Kit, sold per Kit.</i>
N/P/N	35022845 	<b>Drum Cartridge Rebuild Kit</b> Kit Contains: • (1) OPC Drum • (1) Drum Cleaning Blade • (1) Developer Foam Seal/Fuse 1 Kit per Master Carton	Di 200 f, Di 250, Di 250 f, Di 251, DI 251 F, Di 350, Di 350 f, Di 351, DI 351 F	<i>Priced per Kit, sold per Kit.</i>
4002-0291-01	35019888 	<b>OPC Drum</b> 12 Drums per Master Carton	Di 450, Di 470, Di 550	<i>Priced per Drum, sold per Drum.</i>
1155-0292	35018520	<b>OPC Drum</b> <b>Access By Katun</b> 6 Drums per Master Carton	Di 520, Di 620	<i>Priced per Drum, sold per Drum.</i>
4024-0291-01	35022049 	<b>OPC Drum</b> 12 Drums per Master Carton	Di 551, Di 650	<i>Priced per Drum, sold per Drum.</i>
8971-1291-01	35021678 	<b>OPC Drum</b> 6 Drums per Master Carton	Di 750	<i>Priced per Drum, sold per Drum.</i>



For use in  
**Minolta**  
Copiers

**Central/Eastern Europe**  
Telephone: 31(0)183-696969  
Fax: 31(0)183-629055  
E-mail: order@edc.katun.com









OEM PN	KATUN PN	DESCRIPTION	MODEL NO.	
<b>Photoreceptors</b>				
4027-0291-01	35023013 	<b>OPC Drum</b> 6 Drums per Master Carton	Di 850	<i>Priced per Drum, sold per Drum.</i>
N/P/N	35010288 	<b>OPC Drum</b> 50 Drums per Master Carton	EP 70	<i>Priced per Drum, sold per Drum.</i>
1036-0103-05	35502781 	<b>OPC Drum</b> 12 Drums per Master Carton	EP 370, EP 370 Z, EP 410 S, EP 410 Z, EP 415 Z, EP 425 Z, EP 3170, EP 4210, EP 4211, EP 4233	<i>Priced per Drum, sold per Drum.</i>
1036-0103-05	35507881	<b>OPC Drum</b> <b>Access By Katun</b> 12 Drums per Master Carton	EP 370, EP 370 Z, EP 410 S, EP 410 Z, EP 415 Z, EP 425 Z, EP 3170, EP 4210, EP 4211, EP 4233	<i>Priced per Drum, sold per Drum.</i>
1031-0153-05 <i>Final Inventory</i>	35507371 	<b>As2Se3 Drum</b> without Drum Dry Heater or Drum Flanges 6 Drums per Master Carton	EP 850, EP 870	<i>Priced per Drum, sold per Drum.</i>
1159-0291-01	35016772 	<b>OPC Drum</b> 50 Drums per Master Carton	EP 1030, EP 1030 F, EP 1031, EP 1031 F	<i>Priced per Drum, sold per Drum.</i>
4601-300	35021568	<b>Imaging Unit</b> <b>Original</b>	EP 1030, EP 1030 F, EP 1031, EP 1031 F	
N/P/N	35018506 	<b>Imaging Unit Rebuild Kit</b> Kit Contains: • (1) OPC Drum • (1) Drum Cleaning Blade • (2) Developer Spacer Roller • (1) Black Developer • (1) Bulk Fuses 1 OPC Kit per Master Carton	EP 1030, EP 1030 F, EP 1031, EP 1031 F	<i>Priced per OPC Kit, sold per OPC Kit.</i>
1139-0292-01	35012170 	<b>OPC Drum</b> 12 Drums per Master Carton	EP 1050, EP 1052, EP 1054, EP 1080, EP 1081, EP 1083, EP 1085, EP 2010, EP 2030	<i>Priced per Drum, sold per Drum.</i>
1139-0292-01	35016204	<b>OPC Drum</b> <b>Access By Katun</b> 12 Drums per Master Carton	EP 1050, EP 1052, EP 1054, EP 1080, EP 1081, EP 1083, EP 1085, EP 2010, EP 2030	<i>Priced per Drum, sold per Drum.</i>
1136-0293-01	35012584 	<b>OPC Drum</b> 12 Drums per Master Carton	EP 2050	<i>Priced per Drum, sold per Drum.</i>
1136-0293-01	35016205	<b>OPC Drum</b> <b>Access By Katun</b> 12 Drums per Master Carton	EP 2050	<i>Priced per Drum, sold per Drum.</i>
1149-0292-01	35015396 	<b>OPC Drum</b> 12 Drums per Master Carton	EP 2051, EP 2080, EP 3010	<i>Priced per Drum, sold per Drum.</i>



OEM PN	KATUN PN	DESCRIPTION	MODEL NO.	
<b>Photoreceptors</b>				
1050-0154-04 <i>Final Inventory</i>	35502784 	<b>OPC Drum</b> 12 Drums per Master Carton	EP 2100, EP 3120, EP 3150	<i>Priced per Drum, sold per Drum.</i>
1067-0293-01	35010288 	<b>OPC Drum</b> 50 Drums per Master Carton	EP 2120, EP 2121, EP 2130, EP 2131, EP 2150, EP 2151, EP 2152, EP 2153	<i>Priced per Drum, sold per Drum.</i>
1276-300	35013339	<b>Imaging Unit Original</b>	EP 2120, EP 2121, EP 2130, EP 2131, EP 2150, EP 2151, EP 2152, EP 2153	
N/P/N	35010456 	<b>Imaging Unit Rebuild Kit</b> For rebuilding the "new" style IU. OEM Part Number 4436-200 Kit Contains: • (2) Precut Corona Wire • (1) Bulk Fuses • (1) OPC Drum • (1) Black Developer • (1) Drum Cleaning Blade • (2) Developer Unit Seal A 12 Kits per Master Carton	EP 2120, EP 2121, EP 2130, EP 2131, EP 2150, EP 2151, EP 2152, EP 2153	<i>Priced per Kit, sold per Kit.</i>
1135-0296-01	35012585 	<b>OPC Drum</b> 12 Drums per Master Carton	EP 3050	<i>Priced per Drum, sold per Drum.</i>
1135-0296-01	35016206	<b>OPC Drum Access By Katun</b> 12 Drums per Master Carton	EP 3050	<i>Priced per Drum, sold per Drum.</i>
1157-0295	35016202 	<b>OPC Drum</b> 12 Drums per Master Carton	EP 4000	<i>Priced per Drum, sold per Drum.</i>
1134-0296-01	35012586 	<b>OPC Drum</b> 12 Drums per Master Carton	EP 4050	<i>Priced per Drum, sold per Drum.</i>
1134-0296-01	35016207	<b>OPC Drum Access By Katun</b> 12 Drums per Master Carton	EP 4050	<i>Priced per Drum, sold per Drum.</i>
1053-0142-08	35012029 	<b>OPC Drum</b> 12 Drums per Master Carton	EP 4230, EP 4232, EP 4250, EP 4300, EP 4320, EP 5400	<i>Priced per Drum, sold per Drum.</i>
1053-0142-08	35012031	<b>OPC Drum Access By Katun</b> 12 Drums per Master Carton	EP 4230, EP 4232, EP 4250, EP 4300, EP 4320, EP 5400	<i>Priced per Drum, sold per Drum.</i>
1156-0295-01	35016203 	<b>OPC Drum</b> 12 Drums per Master Carton	EP 5000	<i>Priced per Drum, sold per Drum.</i>

For use in  
**Minolta**  
Copiers

**Central/Eastern Europe**  
Telephone: 31(0)183-696969  
Fax: 31(0)183-629055  
E-mail: order@edc.katun.com



















OEM PN	KATUN PN	DESCRIPTION	MODEL NO.	
<b>Photoreceptors</b>				
1078-0292-01	35010079 	<b>OPC Drum</b> 12 Drums per Master Carton	EP 5325	<i>Priced per Drum, sold per Drum.</i>
1076-0292-01	35010084 	<b>OPC Drum</b> 12 Drums per Master Carton	EP 5425	<i>Priced per Drum, sold per Drum.</i>
1076-0292-01	35012217	<b>OPC Drum</b> <b>Access By Katun</b> 12 Drums per Master Carton	EP 5425	<i>Priced per Drum, sold per Drum.</i>
1075-0296-01	35012583 	<b>OPC Drum</b> 12 Drums per Master Carton	EP 6000	<i>Priced per Drum, sold per Drum.</i>
1075-0296-01	35017558	<b>OPC Drum</b> <b>Access By Katun</b> 6 Drums per Master Carton	EP 6000	<i>Priced per Drum, sold per Drum.</i>
1161-0294	35016824 	<b>OPC Drum</b> 12 Drums per Master Carton	EP 6001, EP 8015	<i>Priced per Drum, sold per Drum.</i>
1161-0294	35017559	<b>OPC Drum</b> <b>Access By Katun</b> 6 Drums per Master Carton	EP 6001, EP 8015	<i>Priced per Drum, sold per Drum.</i>
1145-0291-01	35016825 	<b>OPC Drum</b> 12 Drums per Master Carton	EP 8010	<i>Priced per Drum, sold per Drum.</i>
1051-0153-07 <b>Final Inventory</b>	35507371 	<b>As2Se3 Drum</b> without Drum Dry Heater or Drum Flanges 6 Drums per Master Carton	EP 8600, EP 8601, EP 8602	<i>Priced per Drum, sold per Drum.</i>
1140-0291-01	35011981 	<b>OPC Drum</b> 12 Drums per Master Carton	EP 8605	<i>Priced per Drum, sold per Drum.</i>
1074-0293-01	35010080 	<b>OPC Drum</b> without Drum Drive Gear 12 Drums per Master Carton	EP 9765	<i>Priced per Drum, sold per Drum.</i>

















OEM PN	KATUN PN	DESCRIPTION	MODEL NO.	
<b>Picker Fingers</b>				
0966-5770-01	35014547 	<b>Upper Picker Finger</b>	Di 30, EP 3050, EP 4000, EP 4050, EP 5000	<i>Priced per Picker Finger, sold in Packages of 5.</i>
1054-4753-01	35013141 	<b>Upper Picker Finger</b>	Di 181, Di 200 f, Di 251, Di 251 F, Di 351, Di 351 F, EP 1050, EP 1052, EP 1054, EP 1080, EP 1081, EP 1083, EP 1085, EP 2010, EP 2030, EP 2050, EP 2051, EP 2080, EP 3010, EP 3170, EP 4210, EP 4211, EP 4230, EP 4232, EP 4233, EP 4250	<i>Priced per Picker Finger, sold in Bags of 5.</i>
1074-5701-01	35015620 	<b>Upper Picker Finger</b>	Di 520, Di 620, EP 850, EP 870, EP 6000, EP 6001, EP 8010, EP 8015, EP 8600, EP 8601, EP 8602, EP 8605, EP 9765	<i>Priced per Picker Finger, sold in Packages of 6.</i>
1075-5757-01	35242358 	<b>Lower Picker Finger</b>	Di 520, Di 620, EP 6000, EP 6001, EP 8015	<i>Priced per Picker Finger, sold in Bags of 10.</i>
4024-1015-01	35014856 	<b>Lower Picker Finger</b>	Di 551, Di 650	<i>Priced per Set, 3 Picker Fingers per Set.</i>
4014-3013-01	35019648 	<b>Drum Picker Finger</b>	Di 750, Di 850	<i>Priced per Picker Finger, sold in Bags of 3.</i>
1067-5710-01	35013182 	<b>Picker Finger</b>	EP 70, EP 2120, EP 2121, EP 2130, EP 2131, EP 2150, EP 2151, EP 2152, EP 2153	<i>Priced per Picker Finger, sold in Bags of 10.</i>
1131937-020	35015367 	<b>Drum Picker Finger</b>	EP 303 W	<i>Priced per Picker Finger, sold in Packages of 4.</i>
1043-4705-01	35242363 	<b>Picker Finger</b>	EP 370, EP 370 Z, EP 410 S, EP 410 Z, EP 415 Z, EP 425 Z, EP 4300	<i>Priced per Picker Finger, sold in Bags of 10.</i>
1031-4706-01	35242358 	<b>Lower Picker Finger</b>	EP 490 Z, EP 570 Z, EP 850, EP 870, EP 8010, EP 8600, EP 8601, EP 8602, EP 8605, EP 9765	<i>Priced per Picker Finger, sold in Bags of 10.</i>
1052-4701-01	35013095 	<b>Upper Picker Finger</b>	EP 4320, EP 5325, EP 5400, EP 5425	<i>Priced per Picker Finger, sold in Packages of 10.</i>

For use in  
**Minolta**  
Copiers

**Central/Eastern Europe**  
Telephone: 31(0)183-696969  
Fax: 31(0)183-629055  
E-mail: order@edc.katun.com



















OEM PN	KATUN PN	DESCRIPTION	MODEL NO.
<b>Rollers, Fuser/Heat</b>			
1144-5746-04	35021504 	<b>Upper Fuser Roller</b> Silicone Based	CF 900, CF 910
4110-5501-02	35022872 	<b>Upper Fuser Roller</b>	Di 151, Di 151 f
4021-5701-02	35022820 	<b>Upper Fuser Roller</b>	Di 152, Di 152 f, Di 183, Di 183 f
1177-5521-02	35022968 	<b>Upper Fuser Roller</b>	Di 181
1174-5521-02	35022968 	<b>Upper Fuser Roller</b>	Di 181, EP 1054, EP 1085, EP 2030
4012-5730-03	35022060 	<b>Upper Fuser Roller</b>	Di 200 f, Di 251, DI 251 F
1164-5704-01	35022901 	<b>Upper Fuser Roller</b>	Di 250
1165-5703-01	35022901 	<b>Upper Fuser Roller</b>	Di 250, Di 250 f
1165-5706-01	35022902 	<b>Upper Fuser Roller</b>	Di 350, Di 350 f
4117-5702-01	35022902 	<b>Upper Fuser Roller</b>	Di 350, Di 350 f
4002-5701-01	35023245 	<b>Upper Fuser Roller</b> TRITON BLUE™	Di 450, Di 550
1075-5768-01	35023405 	<b>Upper Fuser Roller</b> TRITON BLUE™	Di 520, Di 620, EP 6000, EP 6001, EP 8015
4024-2002-01	35022842 	<b>Upper Fuser Roller</b>	Di 551, Di 650, DI 5510, DI 7210
4014-3015-01	35021654 	<b>Upper Fuser Roller</b>	Di 750
4027-1431-01	35021654 	<b>Upper Fuser Roller</b>	Di 850
1079-5506-01	35011778 	<b>Upper Fuser Roller</b> DURACON™ II	EP 410 S, EP 410 Z, EP 415 Z, EP 425 Z, EP 4230, EP 4233
1031-1708-02	35012814 	<b>Upper Fuser Roller</b> ALUMANA™ Patented TEFLON® coating with reinforcing oxides extends life.	EP 850, EP 870, EP 8600, EP 8601
1139-5562-01	35012464 	<b>Upper Fuser Roller</b> DURACON™ II	EP 1050, EP 1080, EP 1081
1151-5521-02	35022968 	<b>Upper Fuser Roller</b>	EP 1052, EP 1083, EP 2010



OEM PN	KATUN PN	DESCRIPTION	MODEL NO.
<b>Rollers, Fuser/Heat</b>			
N/P/N	35015847 	<b>Upper Fuser Roller Assembly DURACON™ II</b> Includes: • (2) Ball Bearing • (2) Heat Insulating Sleeve	EP 2050, EP 3050, EP 4000, EP 4050
1076-5802-01	35636869 	<b>Upper Fuser Roller DURACON™ II</b>	EP 2050, EP 3050, EP 4000, EP 4050, EP 5325, EP 5425
1012-5521-01	35015397 	<b>Upper Fuser Roller DURACON™ II</b>	EP 2051, EP 2080, EP 3010
1050-1701-04	35636787 	<b>Upper Fuser Roller DURACON™ II</b>	EP 2100, EP 3120
1067-5701-01	35000813 	<b>Upper Fuser Roller DURACON™ II</b>	EP 2120, EP 2121, EP 2150, EP 2151
1132-5701-01	35000813 	<b>Upper Fuser Roller DURACON™ II</b>	EP 2130, EP 2131, EP 2152, EP 2153
1065-5851-01	35000814 	<b>Upper Fuser Roller DURACON™ II</b>	EP 3170, EP 4210, EP 4211
1053-1701-03	35011778 	<b>Upper Fuser Roller DURACON™ II</b>	EP 4300
N/P/N	35010238 	<b>Upper Fuser Roller Assembly DURACON™ II</b> Includes: • (2) Ball Bearing • (2) Heat Insulating Sleeve	EP 4320, EP 5325, EP 5400, EP 5425
1052-1701-03	35636869 	<b>Upper Fuser Roller DURACON™ II</b>	EP 4320, EP 5400
1156-5802-01	35016113 	<b>Upper Fuser Roller DURACON™ II</b>	EP 5000
1074-5714-02	35011315 	<b>Upper Fuser Roller ALUMANA™</b> Patented TEFLON® coating with reinforcing oxides extends life.	EP 8010, EP 9765
1129-2020-01	35012814 	<b>Upper Fuser Roller ALUMANA™</b> Patented TEFLON® coating with reinforcing oxides extends life.	EP 8602
1140-5701-01	35012814 	<b>Upper Fuser Roller ALUMANA™</b> Patented TEFLON® coating with reinforcing oxides extends life.	EP 8602, EP 8605

For use in  
**Minolta**  
Copiers

**Central/Eastern Europe**  
Telephone: 31(0)183-696969  
Fax: 31(0)183-629055  
E-mail: order@edc.katun.com

OEM PN	KATUN PN	DESCRIPTION	MODEL NO.
<b>Rollers, Pressure</b>			
1144-5747-04	35021505 	<b>Lower Pressure Roller</b> Silicone Based	CF 900, CF 910
4110-5502-01	35022053 	<b>Lower Pressure Roller</b> <b>MICROSLEEVE™</b>	Di 151, Di 151 f
4021-5702-01	35022045 	<b>Lower Pressure Roller</b> <b>MICROSLEEVE™</b>	Di 152, Di 152 f, Di 183, Di 183 f
1174-5522-01	35018312 	<b>Lower Pressure Roller</b> <b>MICROSLEEVE™</b>	Di 181, EP 1054, EP 1085, EP 2030, EP 3010
4011-5731-02	35022524 	<b>Lower Pressure Roller</b> <b>MICROSLEEVE™</b>	Di 200 f, Di 251, DI 251 F, Di 351, DI 351 F
1164-5707-01	35018324 	<b>Lower Pressure Roller</b> <b>MICROSLEEVE™</b>	Di 250, Di 250 f, Di 350, Di 350 f
4002-5702-01	35021922 	<b>Lower Pressure Roller</b> <b>MICROSLEEVE™</b>	Di 450, Di 470, Di 550
1129-2021-01	35011120	<b>Lower Pressure Roller</b> <b>MICROSLEEVE™</b> <b>Access By Katun</b>	Di 520, Di 620, EP 6000, EP 6001, EP 8015, EP 8602, EP 8605, EP 9765
4024-1013-01	35022871 	<b>Lower Pressure Roller</b> <b>MICROSLEEVE™</b>	Di 551, Di 650, DI 5510, DI 7210
4014-3031-02	35020932 	<b>Lower Pressure Roller</b> <b>Assembly</b>	Di 750
1029-0761-02	35020962 	<b>Lower Pressure Roller</b> <b>MICROSLEEVE™</b>	EP 470 Z, EP 550 Z, EP 570 Z
1051-1713-01 <i>Final Inventory</i>	35636320 	<b>Lower Pressure Roller</b>	EP 850, EP 870, EP 8600, EP 8601
1159-5702-01	35017450 	<b>Lower Pressure Roller</b>	EP 1030, EP 1030 F, EP 1031, EP 1031 F
1139-5522-01	35013092 	<b>Lower Pressure Roller</b> <b>MICROSLEEVE™</b>	EP 1050, EP 1080, EP 1081
1151-5522-02	35016065 	<b>Lower Pressure Roller</b> <b>MICROSLEEVE™</b>	EP 1052, EP 1083, EP 2010
1136-5779-01	35020954 	<b>Lower Pressure Roller</b> <b>MICROSLEEVE™</b>	EP 2050
1149-5522-01	35016065 	<b>Lower Pressure Roller</b> <b>MICROSLEEVE™</b>	EP 2051, EP 2080
1067-5704-01	35009347 	<b>Lower Pressure Roller</b>	EP 2120, EP 2121, EP 2130, EP 2131, EP 2150, EP 2151, EP 2152, EP 2153
1052-1710-01	35020962 	<b>Lower Pressure Roller</b> <b>MICROSLEEVE™</b>	EP 3050, EP 4000, EP 4050, EP 4320, EP 5325, EP 5400, EP 5425
1156-5803-01	35020955 	<b>Lower Pressure Roller</b> <b>MICROSLEEVE™</b>	EP 5000



Katun Performance Product

© 2004 Katun Corporation

**13 September 2004** For the most current product and pricing information, visit the Katun On-Line Catalog at [www.katun.com](http://www.katun.com).

Prices, terms and conditions are subject to change without notice.

Central/Eastern Europe  
Telephone: 31(0)183-696969  
Fax: 31(0)183-629055  
E-mail: [order@edc.katun.com](mailto:order@edc.katun.com)

For use in  
**Minolta**  
Copiers

OEM PN	KATUN PN	DESCRIPTION	MODEL NO.
-----------	-------------	-------------	--------------

## Rollers, Pressure

1145-5802-01	35019176 	Lower Pressure Roller MICROSLEEVE™	EP 8010
--------------	---	---------------------------------------	---------

For use in  
**Minolta**  
Copiers

**Central/Eastern Europe**  
Telephone: 31(0)183-696969  
Fax: 31(0)183-629055  
E-mail: [order@edc.katun.com](mailto:order@edc.katun.com)

OEM PN	KATUN PN	DESCRIPTION	MODEL NO.
-----------	-------------	-------------	--------------





---

**Thermal Control Devices**

---

4014-1698-01	35021691 	<b>Upper Thermoswitch</b>	CF 5001, Di 750
9334-1310-31	35013233 	<b>Thermoswitch</b>	Di 520, Di 620, EP 6000, EP 6001, EP 8015
9372-2710-31	35017289 	<b>Upper Thermistor</b>	Di 520, Di 620, EP 6000, EP 6001, EP 8015



OEM PN	KATUN PN	DESCRIPTION	MODEL NO.
<b>Toners/Toner Cartridges</b>			
8935-123	35017670	<b>Black Toner Original</b> 295 g / Cartridge	CF 900, CF 910
8935-124	35017671	<b>Yellow Toner Original</b> 295 g / Cartridge	CF 900, CF 910
8935-125	35017672	<b>Magenta Toner Original</b> 295 g / Cartridge	CF 900, CF 910
8935-126	35017673	<b>Cyan Toner Original</b> 295 g / Cartridge	CF 900, CF 910
8937-722	35020800 	<b>Black Toner</b> 413 g / Cartridge Equivalent to 105A, 105B Equivalent to 106A, 106B Equivalent to 302A, 302B 6 Boxes (12 Cartridges) per Master Carton	Di 152, Di 183, DI 1611, DI 2011
8936-604	35020800 	<b>Black Toner</b> 413 g / Cartridge Equivalent to 105A, 105B Equivalent to 106A, 106B Equivalent to 302A, 302B 6 Boxes (12 Cartridges) per Master Carton	Di 181
8936-404	35020800 	<b>Black Toner</b> 413 g / Cartridge Equivalent to 105A, 105B Equivalent to 106A, 106B Equivalent to 302A, 302B 6 Boxes (12 Cartridges) per Master Carton	Di 250, Di 250 f, Di 251, DI 251 F, Di 350, Di 350 f, Di 351, DI 351 F
8936-404	35019191	<b>Black Toner Original</b> 413 g / Cartridge	Di 250, Di 250 f, Di 251, DI 251 F, Di 350, Di 350 f, Di 351, DI 351 F
8936-904	35022085 	<b>Black Toner</b> 1100 g / Cartridge Equivalent to 502A, 502B 6 Cartridges per Master Carton	Di 450, Di 470, Di 550
8936-904	35022704	<b>Black Toner Access By Katun</b> 1100 g / Cartridge Equivalent to 502A, 502B 6 Cartridges per Master Carton	Di 450, Di 470, Di 550
8935-904	35017510 	<b>Black Toner</b> 1600 g / Cartridge Equivalent to 603A, 603B 4 Cartridges per Master Carton	Di 520, Di 620

*Priced per Box,  
2 Cartridges per Box.*

*Priced per Box,  
2 Cartridges per Box.*

*Priced per Box,  
2 Cartridges per Box.*

*Priced per Box,  
2 Cartridges per Box.*

*Priced per Cartridge,  
sold per Cartridge.*

*Priced per Cartridge,  
sold per Cartridge.*

*Priced per Cartridge,  
sold per Cartridge.*

For use in  
**Minolta**  
Copiers





**Central/Eastern Europe**  
Telephone: 31(0)183-696969  
Fax: 31(0)183-629055  
E-mail: order@edc.katun.com

OEM PN	KATUN PN	DESCRIPTION	MODEL NO.	
<b>Toners/Toner Cartridges</b>				
8935-904	35019596	<b>Black Toner</b> <b>Original</b> 1600 g / Cartridge 4 Cartridges per Master Carton	Di 520, Di 620	<i>Priced per Cartridge, sold per Cartridge.</i>
PCUA 950-638	35018895 	<b>Black Toner</b> 1300 g / Cartridge This cartridge is labelled for use in Konica. copiers. 8 Cartridges per Master Carton	Di 750	<i>Priced per Cartridge, sold per Cartridge.</i>
8931-621	35012670	<b>Black Toner</b> <b>Access By Katun</b> 40 g / Cartridge 20 Boxes (80 Cartridges) per Master Carton	EP 70	<i>Priced per Box, 4 Cartridges per Box.</i>
8916-102	35807816 	<b>Black Toner</b> 240 g / Bottle Includes: • (1) Waste Toner Bottle 16 Bottles per Master Carton	EP 470 Z, EP 4230, EP 4232, EP 4233, EP 4250	<i>Priced per Carton, 4 Bottles per Carton.</i>
8935-804	35019604	<b>Black Toner</b> <b>Original</b> 55 g / Cartridge	EP 1030, EP 1030 F, EP 1031, EP 1031 F	<i>Priced per Box, 4 Cartridges per Box.</i>
8935-804	35016972	<b>Black Toner</b> <b>Access By Katun</b> 55 g / Cartridge 20 Boxes (80 Cartridges) per Master Carton	EP 1030, EP 1030 F, EP 1031, EP 1031 F	<i>Priced per Box, 4 Cartridges per Box.</i>
8932-404	35012636 	<b>Black Toner</b> 220 g / Cartridge Equivalent to 101A, 101B 12 Boxes (24 Cartridges) per Master Carton	EP 1050, EP 1080, EP 1081	<i>Priced per Box, 2 Cartridges per Box.</i>
8932-404	35013763	<b>Black Toner</b> <b>Original</b> 220 g / Bottle	EP 1050, EP 1080, EP 1081	<i>Priced per Box, 2 Bottles per Box.</i>
8932-404	35012669	<b>Black Toner</b> <b>Access By Katun</b> 220 g / Cartridge 12 Boxes (24 Cartridges) per Master Carton	EP 1050, EP 1080, EP 1081	<i>Priced per Box, 2 Cartridges per Box.</i>
8935-204	35016254 	<b>Black Toner</b> 240 g / Cartridge Equivalent to 102A, 102B 12 Boxes (24 Cartridges) per Master Carton	EP 1052, EP 1083, EP 2010	<i>Priced per Box, 2 Cartridges per Box.</i>
8935-204	35019603	<b>Black Toner</b> <b>Original</b> 240 g / Cartridge	EP 1052, EP 1083, EP 2010	<i>Priced per Box, 2 Cartridges per Box.</i>
8936-304	35021498 	<b>Black Toner</b> 270 g / Cartridge 12 Boxes (24 Cartridges) per Master Carton	EP 1054, EP 1085	<i>Priced per Box, 2 Cartridges per Box.</i>





Katun Performance Product

© 2004 Katun Corporation

OEM PN	KATUN PN	DESCRIPTION	MODEL NO.	
<b>Toners/Toner Cartridges</b>				
8936-304	35019602	<b>Black Toner Original</b> 270 g / Cartridge	EP 1054, EP 1085	<i>Priced per Box, 2 Cartridges per Box.</i>
8936-204	35018889	<b>Black Toner Access By Katun</b> 410 g / Cartridge 12 Boxes (24 Cartridges) per Master Carton	EP 2030, EP 3010	<i>Priced per Box, 2 Cartridges per Box.</i>
8932-304	35012637 	<b>Black Toner</b> 500 g / Cartridge Equivalent to 201 Equivalent to 201A, 201B 6 Boxes (18 Cartridges) per Master Carton	EP 2050	<i>Priced per Box, 3 Cartridges per Box.</i>
8935-302	35019605	<b>Black Toner Original</b> 360 g / Cartridge	EP 2051, EP 2080	<i>Priced per Box, 2 Cartridges per Box.</i>
8935-302	35016648	<b>Black Toner Access By Katun</b> 360 g / Cartridge 12 Boxes (24 Cartridges) per Master Carton	EP 2051, EP 2080	<i>Priced per Box, 2 Cartridges per Box.</i>
8931-602	35010016 	<b>Black Toner</b> 50 g / Cartridge 18 Boxes (72 Cartridges) per Master Carton	EP 2120, EP 2121, EP 2130, EP 2131, EP 2150, EP 2151, EP 2152, EP 2153	<i>Priced per Box, 4 Cartridges per Box.</i>
8932-604	35017614 	<b>Black Toner</b> 650 g / Cartridge Equivalent to 401A 4 Boxes (16 Cartridges) per Master Carton	EP 3050, EP 4050	<i>Priced per Box, 4 Cartridges per Box.</i>
8932-604	35013827	<b>Black Toner Original</b> 650 g / Bottle	EP 3050, EP 4050	<i>Priced per Box, 4 Bottles per Box.</i>
8931-801	35013717 	<b>Black Toner</b> 150 g / Bottle Includes: • (1) Waste Toner Bottle 36 Bottles per Master Carton	EP 3170, EP 4210, EP 4211	<i>Priced per Carton, 3 Bottles per Carton.</i>
8931-801	35013649	<b>Black Toner Original</b> 150 g / Bottle	EP 3170, EP 4210, EP 4211	<i>Priced per Box, 3 Bottles per Box.</i>
8935-504	35016386 	<b>Black Toner</b> 650 g / Cartridge Equivalent to 501A, 501B 4 Boxes (16 Cartridges) per Master Carton	EP 4000, EP 5000	<i>Priced per Box, 4 Cartridges per Box.</i>
8935-504	35018533	<b>Black Toner Original</b> 650 g / Cartridge	EP 4000, EP 5000	<i>Priced per Box, 4 Cartridges per Box.</i>

For use in  
**Minolta**  
 Copiers



**Central/Eastern Europe**  
 Telephone: 31(0)183-696969  
 Fax: 31(0)183-629055  
 E-mail: order@edc.katun.com

OEM PN	KATUN PN	DESCRIPTION	MODEL NO.	
<b>Toners/Toner Cartridges</b>				
8931-202	35807806	<b>Black Toner</b> <b>Access By Katun</b> 350 g / Bottle 32 Bottles per Master Carton	EP 4320, EP 5400	<i>Priced per Carton, 4 Bottles per Carton.</i>
8932-202	35807806	<b>Black Toner</b> <b>Access By Katun</b> 350 g / Bottle 32 Bottles per Master Carton	EP 5325, EP 5425	<i>Priced per Carton, 4 Bottles per Carton.</i>
8932-704	35016508 	<b>Black Toner</b> 1750 g / Cartridge Equivalent to 602A, 602B 4 Cartridges per Master Carton	EP 6000	<i>Priced per Cartridge, sold per Cartridge.</i>
8935-604	35016508 	<b>Black Toner</b> 1750 g / Cartridge Equivalent to 602A, 602B 4 Cartridges per Master Carton	EP 6001	<i>Priced per Cartridge, sold per Cartridge.</i>
8932-904	35020946	<b>Black Toner</b> <b>Original</b> 670 g / Cartridge	EP 8010	<i>Priced per Box, 4 Cartridges per Box.</i>
8931-142	35012633 	<b>Black Toner</b> 670 g / Cartridge Includes: • (1) Waste Toner Bottle OEM Style Cartridge 1 Box (3 Cartridges) per Master Carton	EP 8600, EP 8601, EP 8602	<i>Priced per Box, 3 Cartridges per Box.</i>



Central/Eastern Europe  
Telephone: 31(0)183-696969  
Fax: 31(0)183-629055  
E-mail: order@edc.katun.com

For use in  
**Minolta**  
Copiers

OEM PN	KATUN PN	DESCRIPTION	MODEL NO.
<b>Waste Toner Containers</b>			
1075-5655-03	35022310 	<b>Toner Collection Bottle</b>	Di 520, Di 620, EP 6000, EP 6001, EP 8015
4444-2027-01	35017532 	<b>Waste Toner Bottle</b>	EP 3050, EP 4000, EP 4050, EP 5000, PF- 5D, PF- 105, PF- 205

## General Information

### Credit Terms and Ordering Information

#### Credit Terms

Standard credit terms are net-30-days from date of invoice. To open a net-30-day account, please contact the Katun Credit Department. Until your credit application is approved, orders will be shipped upon receipt of cash in advance or a confirmed, Sight Draft, or via C.O.D. (Nominal C.O.D. handling charges will apply.)

Katun offers a 3% cash-with-order (CWO) discount. Katun will calculate the 3% discount, promptly inform you of the total charges, and ship your order immediately upon receipt of your payment.

#### Place all orders with Katun (E.D.C.) B.V. via:

- **Telephone: 31(0) 183–696969**
- **Fax: 31(0) 183–629055**
- **E-mail: order@edc.katun.com**
- **Address:**

**Katun (E.D.C.) B.V.**  
**Edisonweg 44**  
**4207 HG Gorinchem**  
**The Netherlands**

Reference Katun part numbers on all orders.

Prices are in Euro, EX WORKS Gorinchem, The Netherlands.

Katun business hours are from 8:30 to 17.00 hours.

Katun has a € 350 minimum order. A € 35 charge will be added to orders under the minimum.

#### Wire transfer funds to:

ABN–AMRO Bank  
Daalsesingel 71  
Postbus 2059  
3500 GB Utrecht  
The Netherlands  
Account Number: 55 70 74 134  
Swift I.D.: ABN ANL 2A  
IBAN: NL51ABNA0557074134

## General Shipping Information and Product Return Policies

### Shipping and Handling

Katun can provide you with alternatives for shipping. We will attempt to select the most convenient and cost-effective carrier for you. However, if you have a preferred carrier, please inform your Katun Customer Service Representative.



## Central/Eastern Europe

Telephone: 31(0)183-696969

Fax: 31(0)183-629055

E-mail: [order@edc.katun.com](mailto:order@edc.katun.com)

Hazardous material shipments will be billed accordingly. A nominal handling charge is incorporated into our shipping costs.

## Product Return Policies

- Katun **must** preauthorize all returns. For return procedures and a return, contact the Customer Service Department at 31(0) 183–696969.
- Toner, toner cartridges, digital duplicator inks and masters, and thermal transfer ribbons with personalized labels cannot be returned to Katun for credit unless a valid warranty claim exists.
- Returns and refused shipments are subject to a minimum 10% restocking charge.
- With the exception of warranty claims, merchandise returned more than 90 days from the invoice date will not be accepted.
- Merchandise which has been written on, marked, relabeled, or placed in other than original Katun packaging will not be accepted.
- All warranty claims submitted to Katun *must* be accompanied by a completed Distributor Choice Warranty Claim Form (included in this catalog). Customers must indicate a warranty choice on the form:
  - (a) Technical Evaluation/ Replacement or technical Evaluation/ Credit: Ship the product and the completed form to:  
**Katun (E.D.C.) B.V.**  
**Edisonweg 44**  
**4207 HG**  
**Gorinchem**  
**The Netherlands**
  - (b) Automatic Replacement: send the completed form to your customer service representative.



## Allgemeine Hinweise

### Zahlungsbedingungen und Bestellinformationen

Die übliche Zahlungsweise ist bar innerhalb von 30 Tagen ab Rechnungsdatum. Zur Eröffnung eines Kontos wenden Sie sich bitte an die Katun Kreditabteilung. Bis zur Gewährung Ihres Kredits erfolgt der Versand von Bestellungen bei Vorkasse oder bei Erhalt eines bestätigten, Sichtwechsel oder gegen Nachnahme (unter Berechnung einer geringen Nachnahmegebühr).

Katun gewährt 3 % Skonto für Barzahlung bei Bestellung. Katun wird den Skontobetrag errechnen, Ihnen den Gesamtbetrag mitteilen und Ihre Bestellung unverzüglich nach Erhalt Ihrer Zahlung zum Versand aufgeben.

Bitte richten Sie alle Bestellungen an Katun (E.D.C.) B.V. unter:

- **Telefon: 31 (0) 183–696969**
- **Fax: 31 (0) 183–629055**
- **E-mail: order@edc.katun.com**
- **Adresse:**

**Katun (E.D.C.) B.V.**  
**Edisonweg 44**  
**NL-4207 HG Gorinchem**  
**Niederlande**

Bitte bei allen Bestellungen die Katun Artikelnummern angeben. Preise verstehen sich in Euro, ab Werk Gorinchem, Niederlande.

Katun Geschäftszeit ist 8.30 - 17.00 Uhr. Für alle Bestellungen gilt ein Mindestbestellwert von € 350. Bei Bestellungen unter dem Mindestbestellwert wird ein Zuschlag von €35 berechnet.

#### Bankverbindung:

ABN AMRO Bank  
Daalsesingel 71  
Postbus 2059  
NL-3500 GB Utrecht  
Niederlande  
Kontonummer: 55 70 74 134  
Bankleitzahl: ABN ANL 2A  
IBAN: NL51ABNA0557074134

### Versand und Warenrücksendung

#### Bearbeitung und Versand

Katun bietet verschiedene Versandmethoden an. Wir bemühen uns, die für Sie günstigste und praktischste Versandart zu wählen. Falls Sie eine bestimmte Versandart/Firma vorziehen, teilen Sie dies bitte Ihrem Katun Repräsentanten mit.



## Central/Eastern Europe

Telephone: 31(0)183-696969

Fax: 31(0)183-629055

E-mail: order@edc.katun.com

Versandkosten für Gefahrgüter werden entsprechend berechnet. Eine geringe Bearbeitungsgebühr ist in unseren Versandgebühren enthalten.

## Warenrücksendung

- Nur von Katun vorher genehmigte Waren- rücksendungen können bearbeitet werden. Bitte lassen Sie sich vom Kundendienst unter der Telefonnummer 31 (0) 183-696969 genaue Anweisungen geben.
- Bei Warenrücksendungen werden 10 % Rücknahmegebühren in Abzug gebracht.
- Toner, Drucker-/Faxkartuschen, Tinten für digitale Duplikatoren sowie Thermo-Transfer-Bänder mit Firmenetiketten sind vom Umtausch ausgeschlossen, es sei denn, es liegt ein Garantiefall vor.
- Ware, die nach Ablauf von 90 Tagen ab Rechnungsdatum zurückgeschickt wird, kann nicht zurückgenommen werden (mit Ausnahme von Reklamationen).
- Ware, deren Verpackung markiert, etikettiert oder beschriftet wurde, oder Ware ohne Originalverpackung kann nicht zurückgenommen werden.
- Alle Garantieansprüche müssen von einem ausgefüllten Händler -Garantieformular begleitet sein ( Formular in diesem Katalog enthalten). Geben Sie Ihren Regulierungswunsch auf dem Formular an:
  - (a) Technische Bewertung/Ersatz oder Technische Bewertung/Gutschrift: schicken Sie das Produkt und das vollständig ausgefüllte Formular an:

**Katun (E.D.C.) B.V.**  
**Edisonweg 44**  
**NL-4207 HG Gorinchem**  
**Niederlande**
  - (b) Ersatz ohne Bewertung: schicken Sie das vollständig ausgefüllte Formular an Ihren Ansprechpartner der Auftragsbearbeitung.

## DISTRIBUTOR CHOICE WARRANTY CLAIM FORM

*Please print all information. For prompt processing of your claim, please complete all sections. Your feedback is important to the ongoing improvement of Katun products. Thank you.*

### I. WARRANTY CHOICE

*Please check one. See Section 2 on reverse side for additional information.*

Technical Evaluation/Replacement       Technical Evaluation/Credit       Automatic Replacement

### II. CUSTOMER INFORMATION

Customer Number: \_\_\_\_\_ Date Shipped: \_\_\_\_\_

Company Name: \_\_\_\_\_ Delivery Date: \_\_\_\_\_

Address: \_\_\_\_\_

City: \_\_\_\_\_ State/Province: \_\_\_\_\_

Country: \_\_\_\_\_ Postal Code: \_\_\_\_\_

Your Name: \_\_\_\_\_ Title: \_\_\_\_\_

### III. PRODUCT INFORMATION

Katun PN	Quantity	Description	Serial/Lot Number
1) _____	_____	_____	_____
2) _____	_____	_____	_____
3) _____	_____	_____	_____
4) _____	_____	_____	_____
5) _____	_____	_____	_____

### IV. DETAILED REASON(S) FOR CLAIM

Provide specific information for each product claimed, explaining the reason for claim in as much detail as possible. Include machine models, machine log information, and copy/print counts. **See Section 3 on reverse side for additional specific requirements for photoreceptors.**

- 1) \_\_\_\_\_
- 2) \_\_\_\_\_
- 3) \_\_\_\_\_
- 4) \_\_\_\_\_
- 5) \_\_\_\_\_

#### **FOR KATUN USE ONLY**

Product Warranty Claim No.: \_\_\_\_\_ Pieces: \_\_\_\_\_  
Received By: \_\_\_\_\_ Date: \_\_\_\_\_



## Central/Eastern Europe

Telephone: 31(0)183-696969

Fax: 31(0)183-629055

E-mail: order@edc.katun.com

## PLEASE READ AND COMPLY WITH ALL THESE REQUIREMENTS TO EXPEDITE THE PROCESSING OF YOUR CLAIM.

### 1. General Instructions

A completed copy of this form must accompany all product warranty claims. Please indicate date of product delivery for determination of warranty coverage time period. *Your feedback is important to the ongoing improvement of Katun products. Please complete all sections on the reverse side.*

### 2. Distributor Choice Warranty Claim Options

Please indicate your choice of Technical Evaluation/Replacement, Technical Evaluation/Credit, or Automatic Replacement. **NOTE:** Automatic Replacement claims must be filed within 90 days of product delivery date, and must not exceed US\$500/€ 550.

If no choice is indicated:

- (a) If product is included with this form, this claim will be treated as Technical Evaluation/Replacement.
- (b) If no product is included with this form, and the claim is less than US\$500/€ 550, this claim will be treated as Automatic Replacement.
- (c) If no product is included with this form, and the claim is more than US\$500/€ 550, the claim is invalid.

### 3. Specific Requirements

If damage (for example, a chip or scratch on a photoreceptor) is noted "out-of-box," **DO NOT INSTALL THE PRODUCT.** No copy/print samples are required. Installing a product with out-of-box damage could void the warranty.

*Include applicable copy/print samples with all claims.* If a photoreceptor is suspected to be defective after machine installation, please attach to this form the copy/print samples indicated below. This will allow a thorough evaluation of the claim. Ensure that neither the form nor copy/print samples will contact the photoreceptor surface during shipment.

**FOR PHOTORECEPTORS USED IN COPIERS,** include:

- (a) Three "sky shot" (open platen; black) copies;
- (b) Three white copies; and
- (c) Three copies of a test pattern.

**NOTE:** If the defect is not visible on the copies indicated above, please attach three copies which clearly show the defect.

**FOR PHOTORECEPTORS USED IN PRINTERS AND PLAIN PAPER FACSIMILES,** include three prints which clearly show the defect.

**IMPORTANT:** The Katun product warranty does not cover damage by operator, technician, or machine (including rotational scratches, gouges, scuff marks, or line scratches).

### 4. Shipping Instructions

**ALL PRODUCT RETURNS MUST BE PROPERLY PACKAGED.** This includes packaging in the correct individual product box and in a second container with adequate protective packaging material. This is required by all carriers.

**NOTE:** Products damaged in transit to Katun due to inadequate packaging cannot be covered by the Katun product warranty, and will be returned.

**Ship Technical Evaluation claims, freight prepaid, to the address specifically indicated for this purpose in the "General Information" section of the Katun On-Line Catalogue and current printed catalogues.** Katun cannot accept responsibility for product warranty claims sent to any other address. **Send Automatic Replacement Claims to your Katun Customer Service Representative.**



## HÄNDLER-GARANTIEFORMULAR

*Das Formular bitte in Druckschrift ausfüllen. Um eine umgehende Bearbeitung Ihrer Reklamation zu ermöglichen, tragen Sie bitte alle Angaben ein.*

*Ihr Feedback trägt zur weiteren Verbesserung von Katun-Produkten bei. Vielen Dank.*

### I. REGULIERUNGSWUNSCH

*Bitte nur einen ankreuzen. Weitere Informationen finden Sie in Abschnitt 2 auf der Rückseite.*

Technische Bewertung/Ersatz     Technische Bewertung/Gutschrift     Ersatz ohne Bewertung

### II. KUNDENINFORMATIONEN

Kunden-Nr.: \_\_\_\_\_ Versanddatum: \_\_\_\_\_

Firmenname: \_\_\_\_\_ Lieferdatum: \_\_\_\_\_

Straße: \_\_\_\_\_

Postleitzahl: \_\_\_\_\_ Ort: \_\_\_\_\_

Land: \_\_\_\_\_

Ihr Name: \_\_\_\_\_ Titel/Funktion: \_\_\_\_\_

### III. PRODUKTINFORMATIONEN

Katun-Artikel-Nr.	Menge	Bezeichnung	Serien-/Lotnummer
1) _____	_____	_____	_____
2) _____	_____	_____	_____
3) _____	_____	_____	_____
4) _____	_____	_____	_____
5) _____	_____	_____	_____

### IV. AUS WELCHEM GRUND REKLAMIEREN SIE DIE WARE?

Machen Sie bitte zu jedem reklamierten Artikel so ausführliche und genaue Angaben wie möglich. Des weiteren benötigen wir Angaben zum Gerätemodell, eine Kopie des Bordbuches sowie Informationen bezüglich der Anzahl der erstellten Kopien/Ausdrucke des Produktes. **Bitte beachten Sie Punkt 3 auf der Rückseite mit wichtigen Informationen zur Reklamation von Fotorezeptoren.**

1) \_\_\_\_\_

2) \_\_\_\_\_

3) \_\_\_\_\_

4) \_\_\_\_\_

5) \_\_\_\_\_

#### **NUR FÜR DEN INTERNEN GEBRAUCH**

Reklamations-Nr.: \_\_\_\_\_ Stückzahl: \_\_\_\_\_

Entgegengenommen von: \_\_\_\_\_ Eingangsdatum: \_\_\_\_\_



## Central/Eastern Europe

Telephone: 31(0)183-696969

Fax: 31(0)183-629055

E-mail: order@edc.katun.com

## BITTE BEACHTEN SIE FOLGENDE HINWEISE, UM DIE BEARBEITUNG IHRER REKLAMATION ZU BESCHLEUNIGEN.

### 1. Allgemeine Hinweise

Verwenden Sie diesen Mängelbericht bei allen Reklamationen. Geben Sie zur Bestimmung der Garantiefrist bitte das Lieferdatum des Produktes an. *Ihr Feedback trägt zur weiteren Verbesserung von Katun-Produkten bei. Bitte tragen Sie alle Angaben auf der Rückseite vollständig ein.*

### 2. Händler-Garantieoption

Geben Sie bitte Ihren Regulierungswunsch an (Technische Bewertung/Ersatz, Technische Bewertung/Gutschrift oder Ersatz ohne Bewertung.) **BITTE BEACHTEN:** Reklamationen ohne Bewertung müssen innerhalb von 90 Tagen nach dem Lieferdatum des Produktes geltend gemacht werden und dürfen einen Wert von USD 500/Euro 550 nicht überschreiten.

Wenn keine Wahl getroffen wurde:

- (a) Wenn diesem Formular das Produkt beigelegt wurde, wird diese Reklamation als Technische Bewertung/Ersatz bearbeitet.
- (b) Wenn diesem Formular kein Produkt beigelegt wurde und der Wert der Reklamation weniger als USD 500/ Euro 550 beträgt, wird diese Reklamation als Ersatz ohne Bewertung bearbeitet.
- (c) Wenn diesem Formular kein Produkt beigelegt wurde und der Wert der Reklamation mehr als USD 500/ Euro 550 beträgt, besteht kein Anspruch auf Reklamation.

### 3. Spezielle Anforderungen

Wenn Schäden (z.B. Splitter oder Kratzer an einem Fotorezeptor) bereits „beim Auspacken“ festgestellt werden, dann **INSTALLIEREN SIE DAS PRODUKT NICHT.** Testkopien sind nicht erforderlich. Die Installation eines Produktes mit bereits bestehendem Schaden könnte zum Erlöschen Ihrer Garantieansprüche führen.

*Fügen Sie allen Reklamationen entsprechende Testkopien bei.* Wenn ein Fotorezeptor nach der Installation einen Defekt aufzuweisen scheint, legen Sie diesem Formular bitte die nachstehend beschriebenen Testkopien bei, um eine genaue Beurteilung der Mängel zu ermöglichen. Das Formular sowie die Testkopien dürfen bei der Rücksendung auf keinen Fall mit der Oberfläche des Fotorezeptors in Berührung kommen.

**FÜR FOTOREZEPTOREN, DIE IN KOPIERERN BENUTZT WURDEN,** folgende Testkopien beilegen:

- (a) 3 schwarze Kopien (bei offener Vorlagenglas-Abdeckung),
- (b) 3 weiße Kopien und
- (c) 3 Testkopien (vom Testbogen).

**BITTE BEACHTEN:** Ist der Defekt auf diesen Mustern nicht sichtbar, legen Sie bitte 3 Kopien bei, auf denen er deutlich zu erkennen ist.

**FÜR FOTOREZEPTOREN, DIE IN DRUCKERN UND NORMALPAPIER-FAXGERÄTEN BENUTZT WURDEN,** legen Sie bitte 3 Kopien bei, auf denen der Defekt deutlich zu erkennen ist.

**WICHTIG:** Schäden, die durch falsche Bedienung des Endanwenders, durch den Techniker oder das Gerät verursacht wurden (d. h. umlaufende Kratzer, Streifen, Abrieb oder querlaufende Kratzer), sind von der Katun Qualitätsgarantie ausgeschlossen.

### 4. Versandrichtlinien

ALLE TEILE, DIE AN UNS ZURÜCKGESANDT WERDEN, MÜSSEN SACHGEMÄSS VERPACKT SEIN, d. h. in dem entsprechenden Einzelkarton und einem zweiten Karton mit entsprechendem Verpackungsmaterial. Dies betrifft jeglichen Transportweg!

**BITTE BEACHTEN:** Teile, die nicht sachgemäß verpackt werden und uns aus diesem Grunde defekt erreichen, sind von der Katun-Qualitätsgarantie ausgeschlossen und werden nicht angenommen.

**Schicken Sie Ihre Reklamation zur technischen Bewertung (frachtfrei) an die für diese Zwecke im Katun-Online-Katalog und dem gültigen regulären Katalog unter den „allgemeinen Hinweisen“ angegebene Adresse.** Katun übernimmt keinerlei Verantwortung für Reklamationen, die an eine andere Adresse als die oben genannte geschickt werden. **Schicken Sie Reklamation zum Ersatz ohne Bewertung an Ihren Katun-Ansprechpartner.**

