

Katun Products for use in
Kyocera Mita

Table of Contents

	<i>Page</i>
Copy Machine Equivalency List	i
Descriptions of Katun Product Brands and Technologies	vii
Beschreibungen der Produktmarken und Technologien von Katun	xi
Personalized Product Agreement	xv
Vereinbarung Über Bestellung Von Produkten Mit Ihrem Firmenetikett	xvii
Bearings/Bushings	1
Belts	4
Blades/Brushes	5
Corona/Charge/Transfer	7
Developers	10
Feed/Delivery	12
Filters	16
Fuser Cleaning	17
Fuser Oil	19
Gears	20
Kits	21
Lamps	22
Memory Upgrades	23
Photoreceptors	24
Picker Fingers	26
Rollers, Fuser/Heat	27
Rollers, Pressure	29
Seals	31
Springs	32
Thermal Control Devices	33
Toners/Toner Cartridges	34
Waste Toner Containers	39
General Information	I
Allgemeine Hinweise	III
Distributor Choice Warranty Claim Form	V
HÄNDLER-GARANTIEFORMULAR	VII



Copy Machine Equivalency List

Central/Eastern Europe
 Telephone: 31(0)183-696969
 Fax: 31(0)183-629055
 E-mail: order@edc.katun.com

Kyocera Mita	Gestetner	Rex Rotary	Triumph-Adler	Utax
AC 6500				CD 20
CC 10	GPC 1	8005	TA 2008	C 88
CC 20	GPC 2	8008		C 89
CC 30	2404	8104	TA 2004	C 40
CC 35			EasyCopy 2104	C 44
			TA 2104	
CC 50	2410 Z	8110 Z	TA 2210	C 90
CC 55	2510 z	8210 Z	DeskCopy 2310	C 96
			TA 2310	
CC 60			DeskCopy 2312	C 98
Ci 7500				DCC 4000
Ci 7600				DCC 4400
CI 9500				DCC 3500
DC A0	LC A0	LC A0		C 011
DC A2	21A2			C 202
DC A2 F				C 208
DC A2 RE	21A2 RE			C 203
DC A2 Z	21A2 Z	80A2 Z		C 204
DC A2 Z II	23A2 Z II	80A2 Z II		C 205
DC 111	2110	7010	TA 210	
DC 111 C	2110 C	7010 C	TA 210 C	C 110
DC 112	2111			
DC 112 C	2111 C	7110 C	TA 210 B	C 114
DC 113	2111 CE			
DC 114	2110 TCE	7210 TCE	TA 210 TC	C 112
DC 121	2000	7040	TA 211	C 160
DC 122		7040 MK II		
DC 122 S	2000 S			
DC 131	2001		TA 212	C 166
DC 132			TA 216	C 170
DC 133 R	2002 R	7040 R	TA 212 R	C 168
DC 142 RE	2112 RE	7215 RE	TA 212 RE	C 115
DC 152 Z	2115 Z	7315	TA 215 Z OLD	C 116 OLD
DC 161	2003		TA 215	C 260
DC 162	2004		TA 215 D	C 266
DC 162 ZS	23A2 Z			C 207
DC 181 R	2005 R	7060 R	TA 218 R	C 321
DC 191			TA 218	C 188
DC 211	2007	7020		C 220
DC 213 RE	2007 RE	7020 RE	TA 220 RE	C 225
DC 232	2006	7070	TA 223	C 288
DC 312 RE	2008 RE	7070 RE	TA 230 RE	C 330
DC 313 Z	2130 Z	7130 Z	TA 230 Z	C 230
DC 313 ZD	2130 ZD	7230 DZ	TA 230 DZ	C 233
DC 412 RE	2140 RE	7145 RE		C 340
DC 513 Z	2150 Z	7050 Z	TA 250 Z	C 350
DC 1001	2200	8010 C	TA 209	C 100
DC 1205	2201	8012 C	TA 2012	C 105
DC 1215			DeskCopy 2412	C 123
			TA 2412	
DC 1255	2203 Z	8112 Z	TA 2212	C 106
DC 1256	2312 Z	8212 Z	TA 2512	C 124
DC 1257	2412 Z	8312 Z		



Copy Machine Equivalency List

Kyocera Mita	Gestetner	Rex Rotary	Triumph-Adler	Utax
DC 1260			DeskCopy 2612 TA 2612	C 127
DC 1405	2202	8214 C		C 104
DC 1415	2301	8014	TA 2014	C 125
DC 1435	2302 Z	8114 Z	TA 2414	C 126
DC 1455	2303 Z	8314 Z	TA 2214	C 128
DC 1460			DeskCopy 2414	C 148
DC 1470			DeskCopy 2614	C 149
DC 1555	2315	8015 Z	TA 2015	C 155
DC 1556	2415 Z	8215 Z	TA 2115	C 154
DC 1560			DeskCopy 2215	C 157
DC 1605	2316	8016	TA 2016	C 140
DC 1655	2216 Z	7315 ZN	TA 215 Z	C 116
DC 1656	2316 Z	8116 Z	TA 2216	C 144
DC 1657	2316 TCE	8216 TCE	TA 2416	C 145
DC 1685	2316 ZD	8316 DEZ	TA 2616	C 142
DC 1755	2417	8017 Z	TA 2017	C 174
DC 1785	2217 ZD	7320 DZ		C 216
DC 1855	2318 Z	8118 Z	TA 2018	C 185
DC 1856	2418 Z	8018	TA 2118	C 184
DC 1860			OfficeCopy 2218	C 187
DC 2050				C 219
DC 2055	2320 Z	8020 TCE	TA 2020	C 250 OLD
DC 2060				C 218
DC 2105	2220	7120	TA 2021	C 222
DC 2155	2321	8021 Z		
DC 2254	2222 Z	8022 Z	TA 2022	C 254
DC 2255	2322 Z	8122 TCE	TA 2122	C 250
DC 2285	2322 ZD	8222 DEZ	TA 2222	C 252
DC 2355	2423	8023 Z	TA 2023	C 234
DC 2360			OfficeCopy 2223	C 237
DC 2555	2325 Z	8025 ZE	TA 2025	C 255
DC 2556	2425 Z	8225 Z	TA 2525	C 264
DC 2557	2425 TCE	8325 TCE		
DC 2560				C 259
DC 2585	2325 ZD	8125 DEZ	TA 2225	C 258
DC 3055	2430	8230 Z	TA 2030	C 294
DC 3060	2530		OfficeCopy 2130	C 307
DC 3255	2332 Z	8132 Z	TA 2032	C 320
DC 3285	2332 ZD	8232 DZ	TA 2232	C 322
DC 3555	2335 Z	8035 Z	TA 2035	C 360
DC 3585	2335 ZD	8135 DZ	TA 2235	C 362
DC 3755	2337 Z	8037 Z	TA 2037	C 370
DC 3785	2337 ZD	8137 DEZ	TA 2237	C 372
DC 4055	2240 Z	7340 ZE		C 240
DC 4056	2440	8140 DZ	TA 2040	C 404
DC 4060	2540		MasterCopy 2140	C 407
DC 4085	2240 ZD	7440 DEZ	TA 2240	C 242
DC 4086	2440 D			
DC 4555	2345 Z	8045 Z	TA 2045	C 450
DC 4585	2345 ZD	8145 DEZ	TA 2245	C 452
DC 4585 F	2345 ZDF	8245 DZF		C 455
DC 4655	2346 Z	8046 Z		

Copy Machine Equivalency List

Central/Eastern Europe
 Telephone: 31(0)183-696969
 Fax: 31(0)183-629055
 E-mail: order@edc.katun.com

Kyocera Mita	Gestetner	Rex Rotary	Triumph-Adler	Utax
DC 4685	2346 ZD	8146 DZ	TA 2246	
DC 4685 F			TA 2446	C 465
DC 5055				C 355
DC 5090			MasterCopy 2250	C 518
DC 5555	2355 Z	8155 Z	TA 2066	C 554
DC 5585	2355 ZDF	8055 DZF	TA 2055	C 550
DC 5590	2655			C 556
DC 5655				C 560
DC 5685	2356 ZDF	8056 DZF	TA 2055 II	C 562
DC 6090	2460	8060 DZF	MasterCopy 2060 TA 2060	C 612
DC 6500				C 658
DC 6590	2665			
DC 7085	2470 ZDH	8070 DZH	TA 2070	C 712
DC 7090			TA 2270	
DC 8090	2480	8080		C 804
DC 8095				C 808
DC 8585	2485 ZDF	8085 DZF		C 812
DC 9285	2492	8092 ZDF		C 924
DR 1000				C 09
DR 3010				C 010
DR 3020				C 012
KM 1500			DC 2315	CD 1315
KM 1505			DC 2115	
KM 1510			DC 2215	CD 1115
				CD 1215
KM 1530			2015 DC 2015	CD 1015
KM 1810			2115 2215	
KM 2030			2020	CD 1020
			DC 2020	
KM 2530			DC 2025	CD 1025
KM 3530			DC 2035	CD 1035
KM 4230				CD 1042
KM 4530			DC 2045	CD 1045
KM 4850 w			CX 8682	CX 9682
				XC 9682
KM 5230				CD 1052
KM 5530			DC 2055	CD 1055
KM 6230			2062 DC 2062	CD 1062
KM 6330			DC 2063	CD 1063
MC 10				C 180
MC 20				C 300
OMEGA D 630			DC 2063	CD 1063
Vi 150			DC 150	CD 16
Vi 155				CD 15
				M 16
Vi 200				CD 21
Vi 230				CD 23
Vi 300			DC 300	CD 37
Vi 310				CD 31

Copy Machine Equivalency List

Kyocera Mita	Gestetner	Rex Rotary	Triumph-Adler	Utax
Vi 400				CD 41
Vi 500				CD 51
Vi 550				CD 55
Vi 600				CD 55
XI 8020				C 026
AD- 52	AD- 52		AD- 52	AD- 52
AD- 53	AD- 53	AD- 53	AD- 53	AD- 53
AD- 54	AD- 54		AD- 54	AD- 54
AD- 55				AD- 55
AD- 56			AD- 56	AD- 56
AD- 60				AD- 60
AD- 61			AD- 61	AD- 61
ADF- 1	ADF- 1	ADF- 1	ADF- 1	ADF- 1
ADF- 1 N	ADF- 1 N	ADF- 1 N	ADF- 1 N	ADF- 1 N
ADF- 2	ADF- 2	ADF- 2	ADF- 2	ADF- 2
ADF- 3	ADF- 3	ADF- 3		ADF- 3
ADF- 4	ADF- 4	ADF- 4	ADF- 4	ADF- 4
ADF- 6	ADF- 6		ADF- 6	ADF- 6
ADF- 7			ADF- 7	ADF- 7
ADF- A2				ADF- A2
ADF- M 5	ADF- M 5	ADF- M 5	ADF- M 5	ADF- M 5
AS- 5	AS- 5	AS- 5	AS- 5	AS- 5
AS- 5 N	AS- 5 N	AS- 5 N		AS- 5 N
AS- 6	AS- 6	AS- 6	AS- 6	AS- 6
AS- 7	AS- 7	AS- 7	AS- 7	AS- 7
AS- 8	AS- 8	AS- 8	AS- 8	AS- 8
AS- 9	AS- 9	AS- 9	AS- 9	AS- 9
AS- 10	AS- 10	AS- 10	AS- 10	AS- 10
AS- 11 A	AS- 11 A	AS- 11 A	AS- 11 A	AS- 11 A
AS- 11 AN	AS- 11 AN	AS- 11 AN	AS- 11 AN	AS- 11 AN
AS- 11 B	AS- 11 B	AS- 11 B	AS- 11 B	AS- 11 B
AS- 11 BN	AS- 11 BN	AS- 11 BN	AS- 11 BN	AS- 11 BN
AS- 1210				AS- 1210
AS- 4020	AS- 4020	AS- 4020	AS- 4020	AS- 4020
AS- 7020 A	AS- 7020 A	AS- 7020 A		AS- 7020 A
AS- 7020 B	AS- 7020 B	AS- 7020 B		AS- 7020 B
AS- F 11	AS- F 11	AS- F 11	AS- F 11	AS- F 11
AS- F 6010			AS- F 6010	AS- F 6010
AS- M 5	AS- M 5	AS- M 5	AS- M 5	AS- M 5
AS- M 10	AS- M 10	AS- M 10	AS- M 10	AS- M 10
AS- S 2010			AS- S 2010	AS- S 2010
AS- S 2020	AS- S 2020	AS- S 2020	AS- S 2020	AS- S 2020
AS- S 2120	AS- S 2120		AS- S 2120	AS- S 2120
AS- S 2210				AS- S 2210
AS- S 5020	AS- S 5020	AS- S 5020	AS- S 5020	AS- S 5020
AS- S 5120	AS- S 5120	AS- S 5120	AS- S 5120	AS- S 5120
AS- S 8020	AS- S 8020	AS- S 8020		AS- S 8020
DF- 1	DF- 1		DF- 1	DF- 1
DF- 2	DF- 2	DF- 2	DF- 2	DF- 2
DF- 3	DF- 3	DF- 3	DF- 3	DF- 3
DF- 4	DF- 4	DF- 4	DF- 4	DF- 4
DF- 71			DF- 71	DF- 71
DF- 75			DF- 75	DF- 75

Copy Machine Equivalency List

Central/Eastern Europe
 Telephone: 31(0)183-696969
 Fax: 31(0)183-629055
 E-mail: order@edc.katun.com

Kyocera Mita	Gestetner	Rex Rotary	Triumph-Adler	Utax
DF- 78			DF- 78	DF- 78
DF- 600			DF- 600	DF- 600
DF- 610			DF- 610	DF- 610
F- 2205			F- 2205	F- 2205
F- 2305			F- 2305	F- 2305
F- 3130				F- 3130
FAX SYSTEM- C			FAX SYSTEM- C	FAX SYSTEM- C
FIERY- X2				FIERY- X2
FIERY- X2 E				FIERY- X2 e
FIERY- X4				FIERY- X4
FIERY- ZX 3300				FIERY- ZX 3300
FIERY- ZX 2100				FIERY- ZX 2100
J- 1302			J- 1302	J- 1302
J- 1402			J- 1402	J- 1402
MD- 4	MD- 4	MD- 4	MD- 4	MD- 4
MD- 6	MD- 6	MD- 6	MD- 6	MD- 6
MD- 9	MD- 9	MD- 9	MD- 9	MD- 9
MD- 10	MD- 10		MD- 10	MD- 10
MD- 14				MD- 14
MD- 15			MD- 15	MD- 15
MULTI BYPASS				MULTI BYPASS
PF- 70			PF- 70	PF- 70
PF- 75			PF- 75	PF- 75
RADF	RADF	RADF		RADF
RADF- 1	RADF- 1	RADF- 1	RADF- 1	RADF- 1
RADF- 2	RADF- 2	RADF- 2	RADF- 2	RADF- 2
RADF- 3	RADF- 3	RADF- 3	RADF- 3	RADF- 3
RADF- 4	RADF- 4	RADF- 4	RADF- 4	RADF- 4
RADF- 5	RADF- 5	RADF- 5	RADF- 5	RADF- 5
RADF- 6	RADF- 6	RADF- 6	RADF- 6	RADF- 6
RADF- 8				RADF- 8
RADF- 9				RADF- 9
RADF- 10				RADF- 10
RDH	RDH	RDH	RDH	RDH
RU- 2				RU- 2
SK- 1	SK- 1	SK- 1	SK- 1	SK- 1
SRDF- 1				SRDF- 1
SRDF- 2			SRDF- 2	SRDF- 2
ST- 1	ST- 1	ST- 1	ST- 1	ST- 1
ST- 2	ST- 2	ST- 2	ST- 2	ST- 2
ST- 2 N	ST- 2 N	ST- 2 N		ST- 2 N
ST- 3	ST- 3	ST- 3	ST- 3	ST- 3
ST- 4	ST- 4	ST- 4	ST- 4	ST- 4
ST- 5	ST- 5		ST- 5	ST- 5
ST- 6	ST- 6	ST- 6	ST- 6	ST- 6
ST- 7	ST- 7	ST- 7	ST- 7	ST- 7
ST- 8	ST- 8		ST- 8	ST- 8
ST- 9			ST- 9	ST- 9
ST- 10				ST- 10
ST- 11			ST- 11	ST- 11
ST- 12			ST- 12	ST- 12
ST- 14			ST- 14	ST- 14
ST- 1100				ST- 1100

Descriptions of Katun Product Brands and Technologies

Katun Performance Products

Katun Performance is our complete line of office automation products that combine our highest quality level with consistent, reliable performance and competitive pricing - and provide excellent overall value.

Katun Performance products meet strict quality guidelines and have been 100% tested and approved according to the Katun 360° Certification process, which includes environmental testing, forward and reverse compatibility testing, model application testing, and component compatibility testing. In addition, all Katun Performance products are warranted to be free from functional defects in material and workmanship for one year and come with the highest level of Katun technical support.

To locate Katun Performance products, look for the Katun Performance icon  throughout this catalog.

Access by Katun Products

Access by Katun is a line of selected products that address the unique pricing or product needs of specific markets. Access by Katun products provide market acceptable quality and market competitive pricing. The Access by Katun product line complements the Katun Performance line by providing a value proposition based primarily on specific market needs.

Access by Katun products come with a limited level of product support and a one-year warranty. Although Access by Katun products provide some price advantages, remember that Katun Performance products always provide excellent overall value.

Original Products

Select OEM brand products that Katun offers to meet certain market needs

Fuser Roller Coating Technologies

Minco Manufacturing, Inc., a wholly owned subsidiary of Katun Corporation, is a world-leading manufacturer of fuser rollers for use in plain paper copiers, facsimiles, and printers. The product development relationship between Katun, Minco, and DuPont, the exclusive manufacturer of genuine TEFLON[®] brand coatings, has produced numerous advanced fuser roller coating technologies, including:

DURAPREM™II upper fuser rollers are manufactured with a heat-resistant, nonstick TEFLON[®] brand coating that provides increased surface hardness for extended potential life. A proprietary finishing process produces an exceptionally smooth surface, which contributes to these rollers' excellent fusing performance and toner release in machines using negative-charge toner.

DURACON™II upper fuser rollers are manufactured with a heat-resistant, nonstick TEFLON[®] brand coating that includes patented conductive additives for static dissipation. These rollers provide excellent fusing performance, toner release, and long life, primarily in machines using positive-charge toner.

ALUMANA™ upper fuser rollers are manufactured with extremely hard, tough primer and midcoat layers for maximum resistance to wear and abrasion. The ceramic ALUMANA coating combines a DuPont-patented polymer blend with reinforcing oxides for enhanced durability. These heavy-duty rollers are specifically designed to meet the demands of hostile fuser station environments and higher-speed machines using either positive-charge or negative-charge toner.

TRITON™II upper fuser rollers are manufactured with an advanced TEFLON[®] brand coating that provides improved fusing performance and nonstick characteristics in comparison to conventional fluoropolymer coatings. Unique static-dissipative particulates within the TRITON II coating, together with enhanced manufacturing processes, contribute to these rollers' superior abrasion- resistance and excellent toner release. These rollers provide extended potential life in selected machines using either positive- charge or negative-charge toner.

Central/Eastern Europe

Telephone: 31(0)183-696969

Fax: 31(0)183-629055

E-mail: order@edc.katun.com

TRITON BLUE™ upper fuser rollers deliver excellent performance for machine applications that are tough on fuser rollers. Manufactured with an advanced TEFLON® brand coating that provides improved fusing performance and nonstick characteristics in comparison to conventional fluoropolymer coatings, TRITON BLUE™ fuser rollers combine improved wear resistance with superior abrasion-resistance and excellent toner release.

REVOLUTION™ upper fuser rollers utilize a PFA sleeve coating that is more environmentally friendly than standard spray technology, while still achieving uniform coating thickness and even heat distribution. These fuser rollers provide proper fusing, excellent abrasion resistance and long life, even during extensive copy runs.

TUF/SIL™ upper fuser rollers are manufactured with a layer of silicone rubber that effectively regulates heat flow to the toner, plus an outermost layer that consists of a specially blended TEFLON® brand coating providing excellent toner release and abrasion-resistance. This combination ensures reduced toner offsetting and improved, more consistent copy quality under certain demanding machine usage conditions. These rollers provide a high-performance, cost-effective solution for selected machines required to consistently produce the best possible copy quality.

MICROSLEEVE™ lower pressure rollers, with nonstick PFA sleeves 50, 70, or 100 microns in thickness, provide excellent wear-resistance for improved copy quality over an extended life. A-Series MICROSLEEVE™ lower pressure rollers are designed specifically for machines utilizing lower fuser cleaning rollers. Their unique surface texture reduces toner buildup and improves cleaning efficiency within the fuser station.

All Katun fuser rollers are designed specifically for their intended applications and manufactured to exacting quality standards, ensuring their excellent performance and long life.

Fuser Cleaning Roller Coating Technologies

Katun has introduced unique fuser cleaning roller technologies for machines requiring efficient removal and absorption of excess toner and contaminants, as well as continuous silicone oil lubrication of critical fuser station parts. For many machines, the ideal parts combination for achieving optimum copy quality and maximum parts life includes a specially designed Katun fuser cleaning roller.

FIBRA™ fuser cleaning rollers incorporate a uniform network of special fibers that aggressively remove excess toner and contaminants from the contacted surface. By efficiently depositing toner and contaminants beneath its outermost surface, the unique FIBRA network also helps maintain a continuous lubricative flow of silicone oil from the roller's internal tank to critical fuser station parts.

FIBRA™ II fuser cleaning rollers incorporate a unique configuration of highly heat-resistant fibers to greatly enhance cleaning performance, especially in hostile fuser station environments. Efficient absorption of excess toner and contaminants, together with continuous silicone oil lubrication of critical fuser station parts, effectively reduce parts and service expenses associated with the fuser station.

TEFLON® is a registered trademark of E.I. DuPont de Nemours and Company used under license by Katun Corporation.

Personalized Product Program

Katun offers an extremely cost-effective way for office equipment dealers/distributors to ensure repeat business and strengthen relations with customers. The **Personalized Product program** enables dealers/distributors to provide high-quality Katun Performance imaging supplies (toner, fax and printer toner cartridges, digital duplicator inks and masters and thermal transfer ribbons) with their business name and /or logo, plus contact information, so end-users always know whom to call to reorder. For a one-time, nominal set-up fee, Katun designs and produces full-color labels to customer specifications and applies them to packaging at no extra charge. Only end-user-replaceable Katun Performance products are eligible under the program. Enrollment is simple and easy. Just complete the agreement form and submit it to your Katun sales representative or visit the [Personalized Products](#) page for more program and enrollment information.



Beschreibungen der Produktmarken und Technologien von Katun

Katun Performance-Produkte

Katun Performance ist unsere umfangreiche Produktreihe von Büromaschinenprodukten, die sich durch hohe Qualität sowie durch beständige, zuverlässige Leistung und attraktive Preise auszeichnen. Mit diesen Produkten soll der Nutzwert für den Kunden maximiert werden.

Katun Performance -Produkte erfüllen strenge Qualitätsstandards und wurden alle im Rahmen des 360° -Zertifizierungsverfahrens von Katun getestet und freigegeben. Die Produkte durchlaufen dabei Prüfungen der Umweltverträglichkeit, der Kompatibilität, der Modellanwendungen und der Komponentenkompatibilität. Darüber hinaus wird bei allen Katun Performance-Produkten ein Jahr lang gewährleistet, dass diese frei von funktionalen Material- und Verarbeitungsfehlern sind. Selbstverständlich steht Ihnen auch der hochwertige technische Support von Katun zur Verfügung.

Um die Katun Performance-Produkte zu finden, halten Sie in diesem Katalog nach dem Namen Performance  und dem entsprechenden Symbol Ausschau.

Originalprodukte

Sie können verschiedene OEM-Produkte auswählen, die Katun aufgrund der Nachfrage auf dem Markt in sein Produktangebot aufgenommen hat.

Beschichtungstechnologien für Heizwalzen

Minco Manufacturing Incorporated, eine hundertprozentige Tochtergesellschaft der Katun Corporation, ist einer der weltweit führenden Hersteller von Heizwalzen für Kopierer, Faxgeräte und Drucker. Die enge Zusammenarbeit zwischen Katun, Minco und DuPont, dem alleinigen Hersteller originaler TEFLON[®] - Beschichtungen, hat zur Entwicklung von zahlreichen neuartigen Beschichtungsmaterialien für Heizwalzen geführt:

DURAPREM[™] II Heizwalzen sind mit einer temperaturbeständigen TEFLON[®] - Antihaf-Beschichtung ausgestattet und besitzen daher eine größere Oberflächenhärte für eine potenziell längere Lebensdauer. Die nach einem speziellen Finish-Verfahren hergestellte, außerordentlich glatte Walzenoberfläche bietet hervorragende Fixier- und Antihaf-Eigenschaften in Geräten mit negativ geladenem Toner.

DURACON[™] II Heizwalzen sind mit einer temperaturbeständigen TEFLON[®] - Antihaf-Beschichtung ausgestattet, der patentierte, elektrisch leitfähige Inhaltsstoffe beigemischt sind, um das Ableiten von sich bildender statischer Ladung zu ermöglichen. Diese Heizwalzen zeichnen sich durch ihre hervorragenden Fixier- und Antihaf-Eigenschaften sowie eine lange Nutzungsdauer aus, besonders in Geräten mit positiv geladenem Toner.

ALUMANA[™] Heizwalzen besitzen eine äußerst harte, widerstandsfähige Grund- und Zwischenschicht für eine höchstmögliche Verschleißfestigkeit und Haltbarkeit. Die ALUMANA Keramiksicht beinhaltet eine patentierte Polymer-Mischung von DuPont mit Verstärkungsoxiden für eine erhöhte Widerstandsfähigkeit.

Diese robusten Heizwalzen sind speziell für anspruchsvolle Betriebsbedingungen in der Fixierstation und für schnellere Kopierer mit positiv oder negativ geladenem Toner konstruiert.

TRITON[™] II Heizwalzen zeichnen sich durch ihre hochwertige TEFLON[®] -Beschichtung aus, die herkömmlichen Fluorpolymer-Beschichtungen in Bezug auf Fixier- und Antihaf-Eigenschaften überlegen ist. Spezielle antistatisch wirkende Partikel in der TRITON II-Beschichtung und hohe Fertigungsstandards tragen zu den ausgezeichneten Antihaf-Eigenschaften und der hervorragenden Verschleißfestigkeit dieser Heizwalzen bei.

Sie bieten potentiell längere Laufzeiten in ausgewählten Geräten sowohl mit positiv als auch mit negativ geladenem Toner.

Central/Eastern Europe

Telephone: 31(0)183-696969

Fax: 31(0)183-629055

E-mail: order@edc.katun.com

Die TRITON BLUE™ Oberen Heizwalzen bieten eine hervorragende Leistung in Maschinenanwendungen, bei denen die Heizwalzen stark beansprucht werden. Die TRITON BLUE™ Heizwalzen werden mit einer fortschrittlichen TEFLON®-Beschichtung hergestellt, die eine höhere Heizleistung und bessere Antihaft-Eigenschaften im Vergleich zu herkömmlichen Fluorpolymerbeschichtungen bietet. Darüber hinaus zeichnen sich diese Heizwalzen durch eine hohe Verschleißfestigkeit aus.

REVOLUTION™ Obere Heizwalzen zeichnen sich durch eine PFA-Beschichtung aus, die umweltfreundlicher ist als die traditionelle Sprühtechnologie. Gleichzeitig werden eine einheitliche Beschichtungsdicke und eine gleichmäßige Hitzeverteilung sichergestellt. Zu den Vorteilen dieser Heizwalzen gehören eine optimale Fixierung, eine hervorragende Verschleißfestigkeit und eine lange Lebensdauer auch bei umfangreichen Druckläufen.

TUF/SIL™ Heizwalzen besitzen eine Silikonbeschichtung, die für eine effiziente regulierte Wärmeableitung an den Toner sorgt, sowie eine besonders zusammengesetzte TEFLON®-Beschichtung mit ausgezeichneten Antihaft-Eigenschaften und hoher Verschleißfestigkeit. Dies führt zu weniger Toner-Offsetting-Problemen und gewährleistet auch unter anspruchsvollen Betriebsbedingungen eine gleichbleibend hohe Kopienqualität. Die TEFLON®/SILIKON Heizwalzen bieten ein sehr gutes Preis-/Leistungsverhältnis für ausgewählte Geräte, die höchste Qualitätsansprüche in Bezug auf die Kopienqualität stellen.

MICROSLEEVE™ Presswalzen mit Antihaft-PFA-Ummantelung in den Stärken 50, 70 und 100 µm bieten eine außergewöhnliche Haltbarkeit und damit eine langfristig bessere Kopienqualität und längere Nutzungsdauer. Die Presswalzen der MICROSLEEVE™ A-Serie sind speziell für den Einsatz in Geräten gedacht, bei denen eine Reinigung der unteren Presswalze mittels Reinigungswalze stattfindet.

Ihre besondere Oberflächenstruktur reduziert Tonerablagerungen und verbessert die Reinigungswirkung in der Fixierstation.

Alle Heizwalzen von Katun wurden speziell im Hinblick auf deren Einsatzzweck entwickelt und erfüllen höchste Qualitätsstandards. Nicht umsonst zeichnen sie sich durch eine herausragende Leistung und eine lange Nutzungsdauer aus.

Beschichtungstechnologien für Reinigungswalzen

Katun hat spezielle Reinigungswalzen für Geräte entwickelt, die eine wirksame Beseitigung von Tonerresten und Schmutz sowie eine kontinuierliche Versorgung wichtiger Teile der Fixierstation mit Silikonöl erfordern. Durch den Einsatz einer Katun Reinigungswalze kann bei vielen Geräten eine optimale Kopienqualität und eine größtmögliche Nutzungsdauer der Komponenten erzielt werden.

FIBRA™ Reinigungswalzen entfernen Tonerreste und Schmutzpartikel durch ein spezielles Fasernetz effizient von der Walzenoberfläche. Während das FIBRA-Fasernetz die Verschmutzungen wirkungsvoll in seiner Oberfläche aufnimmt, sorgt es zugleich für eine Dauerversorgung wichtiger Teile der Fixierstation mit Silikonöl aus dem Vorratstank im Walzeninneren.

FIBRA™II Reinigungswalzen besitzen ein neuartiges, hitzebeständiges Fasernetz, mit denen besonders unter anspruchsvollen Betriebsbedingungen eine erheblich verbesserte Reinigungswirkung erzielt wird.

Durch die wirksame Aufnahme von Tonerresten und Schmutzstoffen bei gleichzeitiger Dauerversorgung wichtiger Teile in der Fixierstation mit Silikonöl können die Austausch- und Servicekosten für die Fixierstation erheblich gesenkt werden.

TEFLON® ist ein eingetragenes Warenzeichen von E.I. DuPont de Nemours and Company und wird von der Katun Corporation unter Lizenz verwendet.

Firmenetiketten-Programm

Katun bietet Händlern einen äußerst kostengünstigen Weg, ihre Kunden an sich zu binden und Kundenbeziehungen zu verbessern. Das **Firmenetiketten-Programm** erlaubt es Händlern, qualitativ hochwertige Verbrauchsmaterialien von Katun Performance (Toner, Drucker-/Faxkartuschen, Tinten für Digitalkopierer und Thermotransferrollen) mit ihrem Firmennamen und/oder Logo sowie mit Kontaktinformationen zu versehen. So wissen Verbraucher immer, bei wem sie Produkte nachbestellen können. Für eine einmalige, geringe Bearbeitungsgebühr entwirft und produziert Katun Performance vollfarbige Etiketten nach Ihren eigenen Angaben. Diese werden kostenfrei auf die entsprechenden Verpackungen aufgebracht. Unter dieses Programm fallen nur Produkte, die vom Endverbraucher nachbestellt werden können. Die Teilnahme an dem Programm ist ganz einfach. Füllen Sie einfach die Vereinbarung aus und senden Sie diese an Ihren Katun- Ansprechpartner oder besuchen Sie uns auf unserer Homepage-unter Firmenetiketten-Programm für weitere Information zu diesem Programm und den Teilnahmebedingungen.

Personalized Product Agreement

Customer Information

Customer Number: _____ Phone Number: _____
 Contact Name: _____ Fax Number: _____
 Title: _____ Katun Representative: _____

Customer agrees to:

- Provide pertinent information, a scanable copy of your company logo, or other desired label artwork, and color specifications for the labels.
- Pay a one-time, nominal setup fee upon approval of the label design. (Ask your sales representative for details.)
- Order in full master carton quantities.

Katun agrees to:

- Create a personalized, full-color label design to your specifications, per the information provided on page two of this form, for a one-time, nominal setup fee and send a proof for approval within a minimum of 7 days of receipt of this agreement.
- Produce labels printed with the customer's approved design on white label stock, and affix them over the Katun Performance logo* on copier toner, printer/fax toner cartridge, digital duplicator ink/master packaging.
- Ship initial order within one week after the customer approves their Personalized Product label proof. Reorders will also ship within one week.

Projected Personalized Product Purchases

<i>Katun Part Number**</i>	<i>OEM Line</i>	<i>Product/Model Description</i>	<i>Minimum Order Quantity</i>	<i>Projected Monthly Order***</i>
P			<i>One master carton</i>	
P			<i>One master carton</i>	
P			<i>One master carton</i>	
P			<i>One master carton</i>	
P			<i>One master carton</i>	
P			<i>One master carton</i>	

Signature: _____ **Date:** _____

*Only Katun Performance products can be personalized.

**The Personalized Product part number is the regular Katun Performance part number with a 'P' added at the end. See the Katun catalog for master carton quantities.

*****Projection only.** You are not committed to ordering the quantity you list on this form.

NOTE: Products with personalized labels cannot be returned to Katun for credit unless a valid warranty claim exists.

Please Also Complete Page 2

Central/Eastern Europe

Telephone: 31(0)183-696969

Fax: 31(0)183-629055

E-mail: order@edc.katun.com

Information for Personalized Product Label

Please list *only* the information you want to appear on your Personalized Product label.

Company Name: _____

Street Address: _____

City: _____

State/Province: _____ **Postal Code:** _____

Phone Number: _____ **Fax Number:** _____

Other: _____

Label Artwork

- **Attach a copy of your company logo and/or any other requested graphic elements.** Artwork may be full color or black and white. We prefer original-quality artwork 4" x 4" (100mm x 100mm) or larger, but will accept a business card or sheet of company letterhead.
- **Please indicate your color preferences.** In the space below, please indicate the color(s) you want to use for all text, your company logo, and any other graphic elements. If appropriate, please supply accurate samples to be matched or specify Pantone or PMS color numbers. **NOTE:** Your labels will be printed on a thermal-transfer printer at a resolution of 300 dpi. Therefore color photographs cannot be printed and some colors may be difficult to match precisely.

Label Sizes

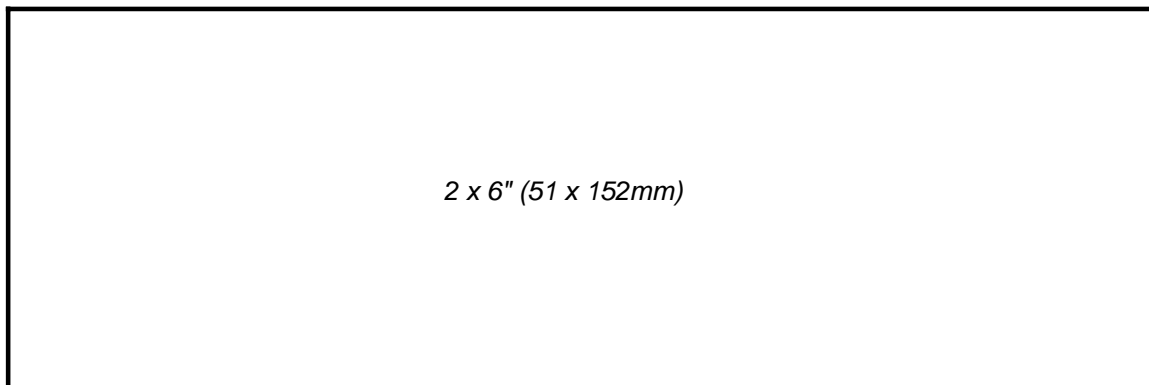
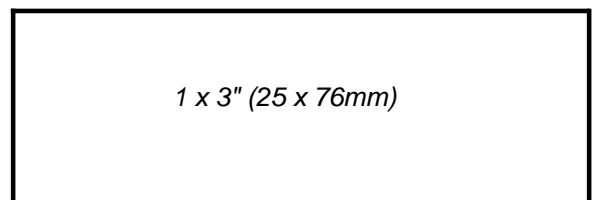
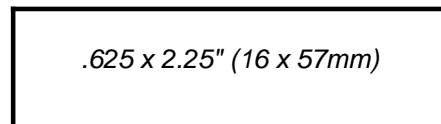
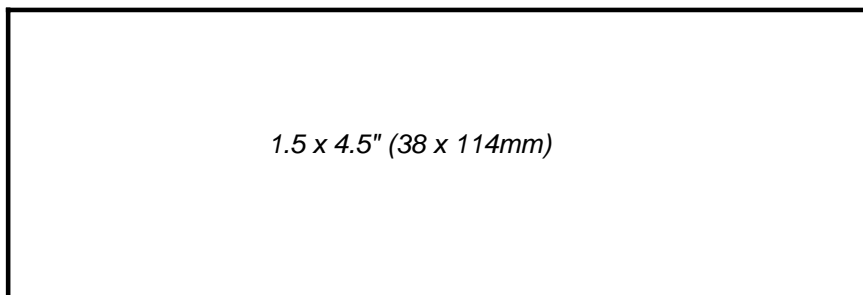

Vereinbarung über Bestellung von Produkten mit Ihrem Firmenetikett

Kundeninformationen

Kundennummer: _____ Telefon: _____
 Ansprechpartner: _____ Fax: _____
 Position: _____ Ihr Katun-Repräsentant: _____

Der Kunde ist einverstanden:

- Katun die benötigten Informationen vorzulegen (ein zum Scannen geeignetes Muster Ihres Firmenlogos bzw. Muster anderer gewünschter Grafikelemente sowie Farbspezifikationen für die Etiketten);
- nach Genehmigung des Etiketten-Layouts eine einmalige, geringe Bearbeitungsgebühr zu entrichten. Weitere Informationen erhalten Sie von Ihrem Katun-Repräsentanten;
- Toner in den jeweiligen Verpackungseinheiten/Umkartons zu bestellen.

Katun verpflichtet sich:

- ein Vollfarbetikett nach den Kundenangaben zu entwerfen (siehe Seite 2 dieses Formulars). Hierfür wird eine einmalige, geringe Bearbeitungsgebühr erhoben. Nach Eingang dieser Vereinbarung bei Katun erhält der Kunde innerhalb von ca. sieben Werktagen einen Korrekturabzug.
- Etiketten in Standardgröße mit dem vom Kunden genehmigten Layout auf weißem Etikettenpapier zu drucken und über dem Katun Performance-Logo* auf der Verpackung von Toner für Kopierer, Tonerkartuschen für Drucker/Faxgeräte, Tinte bzw. deren Umkartons für digitale Duplikatoren anzubringen.
- den Toner-Erstauftrag innerhalb von einer Woche nach Genehmigung des firmeneigenen Etiketts zu versenden. Nachbestellungen werden ebenfalls innerhalb einer Woche erledigt.

Erwartete Abnahmemenge von Produkten mit Ihrem Firmenetikett

Katun Artikelnummer**	Maschinenlinie	Produkt-/Modellbeschreibung	Mindestmenge	Erwartete monatliche Bestellung***
P			Ein Umkarton	
P			Ein Umkarton	
P			Ein Umkarton	
P			Ein Umkarton	
P			Ein Umkarton	
P			Ein Umkarton	

Unterschrift: _____ Datum: _____

*Nur Katun Performance Produkte können mit Firmenetiketten bestellt werden.

**Die Artikelnummer für Produkte mit Ihrem Firmenetikett ist die normale Katun Performance Artikelnummer, der ein "P" am Ende nachgestellt ist. Sehen Sie die Umkartonmengen im Katun-Katalog nach.

*****Nur Schätzungen.** Sie sind nicht verpflichtet, die hier angegebene Menge abzunehmen.

HINWEIS: Produkte mit Firmenetiketten können nur bei einer berechtigten Reklamation gutgeschrieben werden.

Füllen Sie bitte auch Seite 2 aus.

Bestellinformationen für firmeneigenes Etikett

Geben Sie bitte *nur* die Informationen an, die auf dem Etikett erscheinen sollen.

Name der Firma: _____

Strasse: _____

PLZ/Ort: _____

Telefon: _____ Fax: _____

Sonstiges: _____

Layout des Etiketts

- **Bitte legen Sie kein Muster Ihres Firmenlogos sowie ggf. Muster anderer gewünschter Grafikelemente bei.** Geeignet sind Grafiken in Farbe oder Schwarzweiß, vorzugsweise Originale mit einer Mindestgröße von 100 x 100 mm. Wir können auch Ihre Visitenkarte oder Ihren Briefkopf verarbeiten.
- **Bitte geben Sie die gewünschten Farben an.** Tragen Sie unten bitte die Farbe(n) für alle Textelemente, Ihr Firmenlogo sowie andere grafische Elemente ein. Legen Sie ggf. ein Farbmuster bei, oder geben Sie die Pantone- bzw. PMS-Farbnummern an.
HINWEIS: Ihre Firmenetiketten werden auf einem Thermodrucker mit einer Auflösung von 300 DPI erstellt. Es können daher keine Farbfotos gedruckt werden, und bestimmte Farben können u. U. nicht exakt wiedergegeben werden.





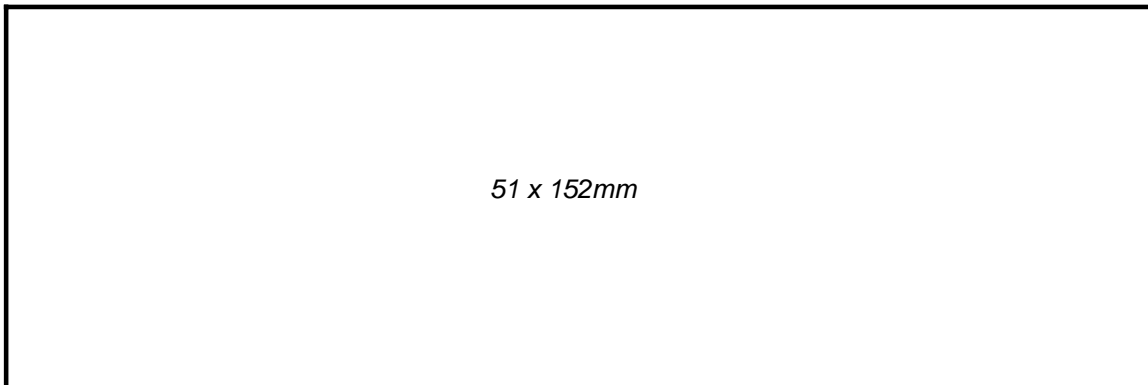
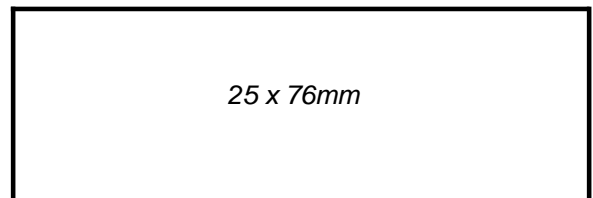
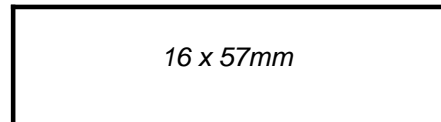
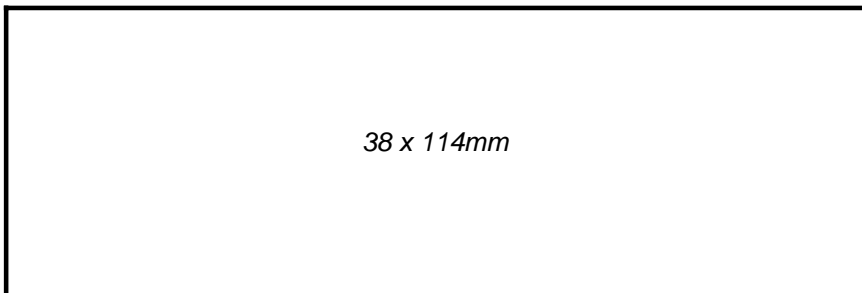

















Etikettengrößen



For use in
Kyocera Mita
 Copiers

Central/Eastern Europe
 Telephone: 31(0)183-696969
 Fax: 31(0)183-629055
 E-mail: order@edc.katun.com

OEM PN	KATUN PN	DESCRIPTION	MODEL NO.
Bearings/Bushings			
28107400	38576233 	Bearing Various Applications Various Applications	KM 1505, KM 1510, KM 1810, KM 4230, KM 5230, KM C 830, KM C 830 D, KM C 850, KM C 850 D, KM C 850 PN, DD- 1, RADF, RADF- 6, RU- 2, SK- 1, ST- 11 AC 6500, DC A2 F, DC 1657, DC 1685, DC 1785, DC 3555, DC 3585, DC 4555, DC 4585, DC 4585 F, DC 5090, DC 5555, DC 5585, DC 5585 H, DC 5590, DC 5655, DC 5660, DC 5685, DC 5690, DC 6090, DC 6500, DC 6590, DC 6595, DC 7085, DC 7090, DC 8090, DC 8095, DC 8585, DC 9285, DR 3020, KM 4530, KM 4850 w, KM 5530, KM 6230, KM 6330, KM 7530, OMEGA D 630, XI 8020, ADF- A2, AS- 7020 A, AS- 7020 B, AS- F 6010, AS- S 5120
75720060	38013292 	Upper Fuser Roller Bushing	AC 6500, DC 1555, DC 1556, DC 1560, DC 1605, DC 1656, DC 1657, DC 1685, DC 1755, DC 1855, DC 1856, DC 1860, DC 2050, DC 2060, DC 2155, DC 2355, DC 2360, DC 2556, DC 2557, DC 2560, DC 3055 <i>Priced per Bushing, sold in Bags of 10.</i>
60912270	38576233 	Bearing Various Applications	Ai 1810 F, DC 1556, DC 1755, DC 1856, DC 2355, DC 2556, DC 2557, DC 3055, DC 3060, DC 3755, DC 3785, DC 4056, DC 4060, DC 4086, DC 4655, DC 4685, DC 4685 F, DC 5090, DC 6500, KM 4230, KM 4530, KM 5230, KM 5530, KM 6330, OMEGA D 630, Vi 150, Vi 155, Vi 200, Vi 230, Vi 230 L, Vi 300, Vi 310, Vi 310 L, Vi 400, Vi 500, DF- 35, DF- 71, F- 4730
35920130	38576233 	Lower Fuser Roller Bearing Various Applications Lower Fuser Roller	KM 4530, KM 5530 Ai 1810 F, KM 1525, KM 1530, KM 2030, KM 2530, KM 3530, KM 4030, Vi 150, Vi 155, Vi 200, Vi 230, Vi 230 L, Vi 310, Vi 310 L
50306090	38576209 	Fuser Roller Bearing For use with Heat Insulating Sleeve OEM Part No. 29720050.	Ci 7500, Ci 7600
50331060	38576233 	Bearing Various Applications Various Applications	F- 8110, F- 8430, RADF- 11 Ci 7500, Ci 7600, KM C 1530, KM C 2030, KM C 2230, KM C 3130, RADF- 8, RADF- 10
49025502	38576203 	Fuser Roller Bearing Upper Upper, Lower	DC A2, DC A2 Z, DC 121, DC 122, DC 122 S, DC 131, DC 132, DC 133 R, DC 161, DC 162, DC 181 R, DC 191, DC 211, DC 213 RE, DC 232, DC 312 RE, DC 313 Z, DC 412 RE, DC 2105, DC 2555, DC 2585, DC 3255, DC 3285, DC 3555, DC 3585, DC 3755, DC 3785, DC 4555, DC 4585, DC 4585 F, DC 4655, DC 4685, DC 4685 F DC A2 F



















OEM PN	KATUN PN	DESCRIPTION	MODEL NO.
Bearings/Bushings			
G3006880	38576118 	Bearing Various Applications Various Applications	KM 4230, KM 4530, KM 5230, KM 5530 DC A2 RE, DC A2 Z, DC A2 Z II, DC 111, DC 111 C, DC 112, DC 112 C, DC 162, DC 191, DC 232, DC 2555, DC 2585, DC 3060, DC 3255, DC 3285, DC 3555, DC 3585, DC 3755, DC 3785, DC 4060, DC 4555, DC 4585, DC 4585 F, DC 4655, DC 4685, DC 4685 F, DC 5590, DC 6090, DC 6590, DC 6595, DC 8090, DC 8095, Vi 400, Vi 500, ST- 3
45528101	38016005 	Upper Fuser Roller Bearing	DC 111, DC 111 C, DC 114
G3060000	38576107 	Bearing Various Applications Lower Fuser Roller	DC 131, DC 132, DC 133 R, DC 161, DC 162, DC 181 R, DC 232, DC 2105, DC 4055, DC 4085, DC 8585, DC 9285 DC 191, DC 211, DC 213 RE, DC 312 RE, DC 412 RE
G3106080	38576204 	Bearing Various Applications	DC 161, DC 162, DC 213 RE, DC 232, DC 4685 F, AS- 7020 A, AS- 7020 B, AS- F 6010
29720040	38576209 	Upper Fuser Roller Bearing For use with Heat Insulating Sleeve OEM Part No. 29720050.	DC 313 ZD, DC 4055, DC 4056, DC 4085, DC 4086, DR 3010, DR 3020
73820070	38015755 	Heat Insulating Sleeve	DC 513 Z, DC 5055, DC 5555, DC 5585, DC 5585 H, DC 5590, DC 5655, DC 5660, DC 5685, DC 5690, DC 6090, DC 7085, DC 7090
45529400	38021630 	Upper Fuser Roller Bearing	DC 513 Z, DC 5055, DC 5555, DC 5585, DC 5585 H, DC 5590, DC 5655, DC 5660, DC 5685, DC 5690, DC 6090, DC 7085, DC 7090, KM 4850 w, XI 8020
77020010	38576205 	Lower Fuser Roller Bearing	DC 1556, DC 1560, DC 1755, DC 1856, DC 1860, DC 2050, DC 2060, DC 2355, DC 2360, DC 2560, DC 3055, Vi 300
72120040	38576225 	Upper Fuser Roller Bearing	DC 2055, DC 2254, DC 2255, DC 2285
72120060	38576205 	Lower Fuser Roller Bearing	DC 2055, DC 2254, DC 2255, DC 2285
65420060	38016005 	Upper Fuser Roller Bearing	DC 3055
G3006860	38015954 	Bearing Various Applications Various Applications	KM C 850, KM C 850 D, KM C 850 PN DC 5090, DC 5590, DC 6590, DC 6595, DC 8090, DC 8095, KM C 830, KM C 830 D, ADF- 1 N, ADF- 2
G3169070	38576216 	Upper Fuser Roller Bearing	DC 5090, DC 6500, DC 6590, DC 6595, DC 8090, DC 8095, DC 8585, DC 9285, KM 6230, KM 6330, KM 7530, OMEGA D 630

*Priced per Heat Sleeve,
 sold in Bags of 10.*











For use in
Kyocera Mita
 Copiers

Central/Eastern Europe
 Telephone: 31(0)183-696969
 Fax: 31(0)183-629055
 E-mail: order@edc.katun.com

OEM PN	KATUN PN	DESCRIPTION	MODEL NO.
Bearings/Bushings			
57306740	38576233 	Bearing Various Applications	DC 5585 H, DC 5690, DC 7085, DC 7090
5A824360	38576118 	Bearing	KM 8530
5C319240	38576205 	Bearing	KM 8530
5C319540	38576203 	Bearing	KM 8530
5C330690	38016005 	Bearing Fuser Auxiliary Roller	KM 8530
5C330800	38576205 	Bearing	KM 8530
5C330940	38576204 	Bearing	KM 8530
5C331100	38576233 	Bearing	KM 8530
5A818460	38014269 	Heat Insulating Sleeve	KM 8530, Vi 550, Vi 600
5A818470	38576216 	Upper Fuser Roller Bearing	KM 8530, Vi 550, Vi 600
5A810950	38576233 	Bearing Various Applications Various Applications	KM 8530, DF- 630, DF- 635, F- 8230, F- 8330, LT- 402, LT- 412, ST- 4000, ST- 4001, TU- 108 Vi 550, Vi 600
5C319380	38576118 	Bearing	KM 8530, DF- 630, DF- 635
5C319220	38576233 	Bearing	KM 8530, DF- 630, DF- 635, F- 8230, F- 8330, TU- 108
G3169010	38018657 	Bearing	KM C 830, KM C 830 D, KM C 850, KM C 850 D, KM C 850 PN
5A826440	38021522 	Lower Fuser Roller Bearing	Vi 550, Vi 600
58010160	38576204 	Bearing	AS- S 5020
58620940	38576204 	Bearing Various Applications	AS- S 8020
50209310	38576118 	Bearing	RADF- 8, RADF- 10, RADF- 11

















*Priced per Heat Sleeve,
 sold in Bags of 10.*

















OEM PN	KATUN PN	DESCRIPTION	MODEL NO.
Belts			
36793281	38022269 	Transfer Belt	DC 5090, DC 6500, KM 6230, KM 6330, KM 7530, OMEGA D 630
65708010 <i>Final Inventory</i>	38021609 	Original Document Feed Belt Fabric Reinforced	DC 5090, DC 6500, RADF- 5, RADF- 6
68721651 <i>Final Inventory</i>	38017589 	Separation Belt	DC 5090, AD- 54, AD- 56
57316090	38018127 	Original Document Feed Belt	DC 5585 H, DC 5690, DC 7085, DC 7090, RDH
63208180	38012037 	Original Document Feed Belt	DC 5590, DC 6090, DC 6590, DC 6595, DC 8090, DC 8095, UDH
5A824440	38012538 	Original Document Feed Belt	Vi 550, Vi 600
59608000	38019644 	Original Document Feed Belt	ADF- 6, ADF- 7
57904580	38012545 	Original Document Feed Belt	RADF- 4
50210010	38014361 	Original Document Feed Belt	RADF- 8, RADF- 10

For use in
Kyocera Mita
 Copiers



Central/Eastern Europe
 Telephone: 31(0)183-696969
 Fax: 31(0)183-629055
 E-mail: order@edc.katun.com







OEM PN	KATUN PN	DESCRIPTION	MODEL NO.
Blades/Brushes			
73920080	38012697 	Fuser Roller Cleaning Blade	AC 6500, DC 1205, DC 1255, DC 1405, DC 1555, DC 1556, DC 1560, DC 1605, DC 1656, DC 1657, DC 1685, DC 1755, DC 1855, DC 1856, DC 1860, DC 2050, DC 2060, DC 2155, DC 2355, DC 2360, DC 2556, DC 2557, DC 2560, DC 3055, DC 3060, DC 4060, Vi 300
			<i>Priced per Blade, sold in Packages of 5.</i>
35993432	38019969 	Drum Cleaning Blade	Ai 1810 F, Vi 150, Vi 155, Vi 200
63818012	38014640 	Drum Cleaning Blade	CC 50, CC 55, DC 1215, DC 1256, DC 1260
50306130	38018830 	Drum Cleaning Blade	Ci 7500, Ci 7600
43228102	38244598 	Drum Cleaning Blade	DC 111, DC 111 C, DC 114
43228102	38022575	Drum Cleaning Blade Access By Katun	DC 111, DC 111 C, DC 114
43228105 <i>Final Inventory</i>	38243450 	Drum Cleaning Blade Seal	DC 111, DC 111 C, DC 114
43229205 <i>Final Inventory</i>	38243452 	Seal Blade	DC 152 Z, DC 1655, DC 1785, DC 2055, DC 2254, DC 2255, DC 2285
77718060	38243463 	Drum Cleaning Blade	DC 152 Z, DC 1655, DC 1785, DC 2055, DC 2254, DC 2255, DC 2285, DC 2555, DC 2585, DC 3255, DC 3285, DC 3555, DC 3585, DC 4555, DC 4585, DC 4585 F
43228203	38243483 	Drum Cleaning Blade B Japan	DC 211, DC 213 RE, DC 313 Z, DC 313 ZD, DC 2105
43228202	38243482 	Drum Cleaning Blade A Japan	DC 211, DC 213 RE, DC 313 Z, DC 2105
43229501	38243482 	Drum Cleaning Blade A Japan	DC 313 ZD
73918030	38243449 	Upper Drum Cleaning Blade	DC 1205, DC 1255, DC 1415, DC 1435, DC 1455
73918030	38022576	Upper Drum Cleaning Blade Access By Katun	DC 1205, DC 1255, DC 1415, DC 1435, DC 1455
75718022	38013179 	Drum Cleaning Blade	DC 1555, DC 1605, DC 1656, DC 1657, DC 1685, DC 1855, DC 2155
66018023	38012929 	Drum Cleaning Blade	DC 1556, DC 1755
34993370	38019184 	Drum Cleaning Blade	DC 1560, DC 1860, DC 2050, DC 2060, DC 2360, DC 2560
66218092	38015554 	Drum Cleaning Blade	DC 1856, DC 2355

OEM PN	KATUN PN	DESCRIPTION	MODEL NO.
Blades/Brushes			
60918040	38011228 	Drum Cleaning Blade	DC 2556, DC 2557, DC 3055
33918012	38016216 	Drum Cleaning Blade	DC 3060, DC 4060
64318031	38012698 	Drum Cleaning Blade	DC 3755, DC 3785, DC 4655, DC 4685, DC 4685 F
72418080 <i>Final Inventory</i>	38243448 	Drum Cleaning Blade	DC 4055, DC 4085
67318020	38013906 	Drum Cleaning Blade	DC 4056, DC 4086
77618310	38243494 	Drum Cleaning Blade	DC 5055, DC 5555, DC 5585, DC 5585 H, DC 5590, DC 5655, DC 5660, DC 5685, DC 5690, DC 6090, DC 6590, DC 6595, DC 7085, DC 7090, DC 8090, DC 8095
61718041 <i>Final Inventory</i>	38013907 	Drum Cleaning Brush	DC 5590, DC 6090
2A193050	38022931 	Drum Cleaning Blade B	KM 1505, KM 1510, KM 1810
2AC93030	38019972 	Drum Cleaning Blade	KM 4230, KM 4530, KM 5230, KM 5530, Vi 400, Vi 500
5C315671 <i>Final Inventory</i>	38021534 	Toner Guide Brush Assembly	KM 8530
5HA10010	38019787 	Drum Cleaning Blade	KM 8530
2AR93102	38019970 	Drum Cleaning Blade	Vi 230, Vi 230 L, Vi 310, Vi 310 L
18593550	38019971 	Drum Cleaning Blade	Vi 300
55WA-2040	38021573 	Toner Collection Assembly	Vi 550, Vi 600
55WA20020	38021730 	Drum Cleaning Blade	Vi 550, Vi 600

For use in
Kyocera Mita
 Copiers

Central/Eastern Europe
 Telephone: 31(0)183-696969
 Fax: 31(0)183-629055
 E-mail: order@edc.katun.com





OEM PN	KATUN PN	DESCRIPTION	MODEL NO.
Corona/Charge/Transfer			
41626652	38375138 	Corona Wire Spool 100 m / Spool 50μ Oxidized Charge	AC 6500, DC 1205, DC 1215, DC 1255, DC 1256, DC 1260, DC 1405, DC 1415, DC 1435, DC 1455, DC 1460, DC 1470, DC 1555, DC 1556, DC 1560, DC 1605, DC 1656, DC 1657, DC 1685, DC 1755, DC 1855, DC 1856, DC 1860, DC 2155, DC 2355, DC 2360, DC 2556, DC 2557, DC 3055, DC 4056, DC 4086 All Applications CC 10, CC 20, CC 50, DC A2, DC A2 RE, DC A2 Z, DC 111, DC 111 C, DC 112, DC 112 C, DC 113, DC 114, DC 121, DC 122, DC 122 S, DC 131, DC 132, DC 133 R, DC 142 RE, DC 152 Z, DC 161, DC 162, DC 181 R, DC 191, DC 211, DC 213 RE, DC 232, DC 312 RE, DC 412 RE, DC 1001, DC 1655, DC 1785, DC 2055, DC 2105, DC 2254, DC 2255, DC 2285, DC 2555, DC 2585, MC 10, MC 20 Transfer, Separation DC 313 Z, DC 313 ZD, DC 513 Z, DC 4055, DC 4085, DC 5055, DC 5555, DC 5585, DC 5585 H, DC 5655, DC 5660, DC 5685, DC 5690, DC 7085, DC 7090 Charge, Transfer Separation DC 1257 DC 3255, DC 3285, DC 3555, DC 3585, DC 3755, DC 3785, DC 4555, DC 4585, DC 4585 F, DC 4655, DC 4685, DC 4685 F
42929503	38375139 	Corona Wire Spool 100 m / Spool 60μ 0.3μ Gold Plated Transfer, Separation	AC 6500, DC 1205, DC 1255, DC 1405, DC 1415, DC 1435, DC 1455, DC 1460, DC 1470, DC 1555, DC 1605, DC 1656, DC 1657, DC 1685, DC 1855, DC 1860, DC 2060, DC 2155, DC 2360, DC 2556, DC 2557, DC 2560, DC 3055, DC 4056, DC 4086, DC 5590, DC 6090, DC 6590, DC 6595, DC 8090 Charge DC A2 Z II, DC 313 Z, DC 313 ZD, DC 513 Z, DC 4055, DC 4085, DC 5055, DC 5555, DC 5585, DC 5585 H, DC 5655, DC 5660, DC 5685, DC 5690, DC 7085, DC 7090, KM 4230, KM 5230, Vi 400, Vi 500 Transfer DC 1215, DC 1256, DC 1260, DC 1556, DC 1560, DC 1755, DC 1856, DC 2355 All Applications DC 3060, DC 4060, DC 8585, DC 9285 Charge, Transfer DC 3255, DC 3285, DC 3555, DC 3585, DC 3755, DC 3785, DC 4555, DC 4585, DC 4585 F, DC 4655, DC 4685, DC 4685 F









OEM PN	KATUN PN	DESCRIPTION	MODEL NO.
Corona/Charge/Transfer			
N/P/N	38375228 	Corona Wire Spool Platinum alloy clad technology extends corona wire life. 60μ 7.5 m / Spool Transfer, Separation Charge Transfer Charge, Transfer All Applications	AC 6500, DC 1205, DC 1255, DC 1405, DC 1415, DC 1435, DC 1455, DC 1555, DC 1605, DC 1656, DC 1657, DC 1685, DC 1855, DC 2155, DC 2556, DC 2557, DC 6090, DC 8090, DC 8095 DC A2 Z II, DC 313 Z, DC 313 ZD, DC 513 Z, DC 4055, DC 4085, DC 5055, DC 5555, DC 5585, DC 5585 H, DC 5655, DC 5660, DC 5685, DC 5690, DC 7085, DC 7090 DC 1256, DC 1755, DC 1856, DC 2355 DC 3255, DC 3285, DC 3555, DC 3585, DC 3755, DC 3785, DC 4555, DC 4585, DC 4585 F, DC 4655, DC 4685, DC 4685 F DC 8585, DC 9285
74669000	38011002 	Corona Wire Spool 50 m / Spool 60μ Oxidized Charge All Applications	Ai 1810 F, DC 5090, DC 5590, DC 6090, DC 6500, DC 6590, DC 6595, DC 8090, DC 8095, KM 4230, KM 4530, KM 5230, KM 5530, Vi 150, Vi 155, Vi 200, Vi 300, Vi 400, Vi 500 DC A2 F
50369030	38375208 	Corona Wire 60μ 0.3μ Gold Plated Pretransfer	Ci 7500, Ci 7600
34910040	38016700 	Charge Corona Grid	DC 1560, DC 2360
N/P/N	38375549 	Grid Wire Spool 50 m / Spool 100μ Stainless Steel	DC 6090
61768110	38375121 	Grid Wire Spool 50 m / Spool 100μ 0.3μ Gold Plated	DC 6090, DC 8090, DC 8095
74710090	38375547 	Corona Wire Spool 50 m / Spool 80μ 0.3μ Gold Plated Charge	DR 3010, DR 3020

*Priced per Set,
 10 Corona Wires per Set.*

For use in
Kyocera Mita
 Copiers



Central/Eastern Europe
 Telephone: 31(0)183-696969
 Fax: 31(0)183-629055
 E-mail: order@edc.katun.com













OEM PN	KATUN PN	DESCRIPTION	MODEL NO.
Corona/Charge/Transfer			
74716280	38011002 	Corona Wire Spool 50 m / Spool 60μ Oxidized Transfer, Separation All Applications	DR 3010, DR 3020, KM 4850 w XI 8020
5C311240	38021637 	Charge Corona Grid	KM 8530
55FA25011	38015764 	Corona Wire 60μ "Skin Pass Corona Wire"	Vi 550, Vi 600 <i>Priced per Corona Wire, sold in Sets of 10.</i>
5A812500	38017260 	Charge Corona Grid	Vi 550, Vi 600
5A812770	38013105 	Corona Wire 60μ Oxidized Transfer, Separation	Vi 550, Vi 600 <i>Priced per Set, 10 Corona Wires per Set.</i>

OEM PN	KATUN PN	DESCRIPTION	MODEL NO.	
Developers				
37002732 <i>Final Inventory</i>	38818131 	Black Developer 900 g / Bottle 10 Bottles per Master Carton	DC A2 RE, DC A2 Z, DC A2 Z II, DC 152 Z, DC 1655, DC 1785, DC 2555, DC 2585, DC 3255, DC 3285	<i>Priced per Bottle, sold per Bottle.</i>
37002832 <i>Final Inventory</i>	38818131 	Black Developer 900 g / Bottle 10 Bottles per Master Carton	DC A2 RE, DC A2 Z, DC A2 Z II, DC 152 Z, DC 1655, DC 1785, DC 2555, DC 2585, DC 3255, DC 3285	<i>Priced per Bottle, sold per Bottle.</i>
37031110	38817839 	Black Developer 350 g / Bottle 10 Bottles per Master Carton	DC 114, DC 1205, DC 1255	<i>Priced per Bottle, sold per Bottle.</i>
37002122 <i>Final Inventory</i>	38818113 	Black Developer 900 g / Bottle 10 Bottles per Master Carton	DC 211, DC 213 RE, DC 313 Z, DC 313 ZD, DC 2105, DC 4055, DC 4085	<i>Priced per Bottle, sold per Bottle.</i>
37068110	38013589	Black Developer Original 220 g / Bottle	DC 1215, DC 1256, DC 1260	
12510020	38010573 	Black Developer 310 g / Bottle 10 Bottles per Master Carton	DC 1415, DC 1435, DC 1455	<i>Priced per Bottle, sold per Bottle.</i>
37054110	38010573 	Black Developer 310 g / Bottle 10 Bottles per Master Carton	DC 1415, DC 1435, DC 1455	<i>Priced per Bottle, sold per Bottle.</i>
37098110	38016981	Black Developer Original 220 g / Bottle	DC 1460, DC 1470	
37046110	38818102 	Black Developer 650 g / Bottle 10 Bottles per Master Carton	DC 1555, DC 1605, DC 1656, DC 1657, DC 1685, DC 1855, DC 2155	<i>Priced per Bottle, sold per Bottle.</i>
37046110	38013561	Black Developer Original 650 g / Bottle	DC 1555, DC 1605, DC 1656, DC 1657, DC 1685, DC 1855, DC 2155	
37067110	38016008 	Black Developer 450 g / Bottle 10 Bottles per Master Carton	DC 1556, DC 1755, DC 1856, DC 2355	<i>Priced per Bottle, sold per Bottle.</i>
37067110	38013549	Black Developer Original 450 g / Bottle	DC 1556, DC 1755, DC 1856, DC 2355	
37090109	38015689	Black Developer Original 850 g / Bottle	DC 1560, DC 1860, DC 2050, DC 2060, DC 2360, DC 2560	
37090111	38015689	Black Developer Original 850 g / Bottle	DC 1560, DC 1860, DC 2360	

For use in
Kyocera Mita
 Copiers













Central/Eastern Europe
 Telephone: 31(0)183-696969
 Fax: 31(0)183-629055
 E-mail: order@edc.katun.com















OEM PN	KATUN PN	DESCRIPTION	MODEL NO.
Developers			
37037110	38817822 	Black Developer 550 g / Bottle 10 Bottles per Master Carton	DC 2055, DC 2254, DC 2255, DC 2285 <i>Priced per Bottle, sold per Bottle.</i>
37058110	38015640 	Black Developer 650 g / Bottle 10 Bottles per Master Carton	DC 2556, DC 2557, DC 3055 <i>Priced per Bottle, sold per Bottle.</i>
37058110	38013557	Black Developer Original 650 g / Bottle	DC 2556, DC 2557, DC 3055
37085110	38015691	Black Developer Original 800 g / Bottle	DC 3060, DC 4060
37061110	38013604 	Black Developer 1050 g / Bottle 10 Bottles per Master Carton	DC 3755, DC 3785, DC 4655, DC 4685, DC 4685 F <i>Priced per Bottle, sold per Bottle.</i>
37016110	38019190	Black Developer Original 600 g / Bottle	KM 1525, KM 1530, KM 2030, Vi 230, Vi 230 L, Vi 310, Vi 310 L

OEM PN	KATUN PN	DESCRIPTION	MODEL NO.	
Feed/Delivery				
5AA08340	38019943 	Paper Pickup Roller Ribbed Tire For Document Feeder	DC 1470	<i>Priced per Pickup Roller, sold in Bags of 10.</i>
5AA08470	38014070 	Original Feed Roller Tire Only	DC 1470	<i>Priced per Tire, sold in Bags of 4.</i>
60906161	38012115 	Paper Pickup Roller Tire Only Ribbed Tire	DC 1856, DC 2355, DC 2556, DC 2557, DC 3055, DC 3060, DC 4060, DC 5090, DC 6500, KM 6230, KM 6330, KM 7530, OMEGA D 630, Vi 300, AD- 53, MD- 4, MD- 6, MD- 9, MD- 10, ST- 5	<i>Priced per Tire, sold in Bags of 10.</i>
66106110	38015401 	Paper Feed Roller Tire Only	DC 1856, DC 2355, AD- 53, MD- 9, ST- 5	<i>Priced per Tire, sold in Bags of 10.</i>
61706770	38020148 	Bypass Upper Separation Roller Tire Only	DC 1860, DC 2060, DC 2360, DC 2560, DC 3060, DC 4056, DC 4060, DC 4086, DC 5090, DC 5590, DC 6090, DC 6500, DC 6590, DC 6595, DC 8090, DC 8095, KM 2530, KM 3035, KM 3530, KM 4030, KM 4035, KM 4230, KM 4530, KM 5035, KM 5230, KM 5530, KM 6230, KM 6330, KM 7530, OMEGA D 630, Vi 300, Vi 400, Vi 500, AD- 56, MD- 10, MULTI BYPASS, ST- 9	<i>Priced per Tire, sold in Bags of 10.</i>
61706780	38020757 	Bypass Lower Separation Roller Tire Only	DC 1860, DC 2060, DC 2360, DC 2560, DC 4056, DC 4086, DC 5090, DC 5590, DC 6090, DC 6500, DC 6590, DC 6595, DC 8090, DC 8095, KM 6230, KM 6330, KM 7530, OMEGA D 630	<i>Priced per Tire, sold in Bags of 10.</i>
34806090	38012115 	Paper Feed Tire Tire Only Ribbed Tire	DC 1860, DC 2060, DC 2360, DC 2560, KM 4230, KM 5230, Vi 400, Vi 500, AD- 56, ST- 9	<i>Priced per Tire, sold in Bags of 10.</i>
72707110	38013621 	Bypass Upper Paper Feed Roller Tire Only	DC 2055, DC 2254, DC 2255, DC 2285, DC 2556, DC 2557, DC 3055, DC 5655, DC 5660, DC 5685, DC 5690, DC 7085, DC 7090	<i>Priced per Tire, sold in Bags of 10.</i>
71806260	38636681 	Bypass Feed Roller Tire Only	DC 2555, DC 2585, DC 3255, DC 3285, DC 3555, DC 3585, DC 3755, DC 3785, DC 4555, DC 4585, DC 4585 F, DC 4655, DC 4685, DC 4685 F	<i>Priced per Tire, sold in Bags of 10.</i>
60906131	38012114 	Paper Feed Tire Tire Only Ribbed Tire	DC 2556, DC 2557, DC 3055, MD- 4, MD- 6	<i>Priced per Tire, sold in Bags of 10.</i>
33906060	38020148 	Lower Paper Feed Roller Tire Only	DC 3060, DC 4060, DC 5090, DC 6500, KM 4230, KM 4530, KM 5230, KM 5530, KM 6230, KM 6330, KM 7530, OMEGA D 630, Vi 300, Vi 400, Vi 500	<i>Priced per Tire, sold in Bags of 10.</i>
68721030	38020149 	Duplex Turn Over Roller Tire Only	DC 5090, KM 4230, KM 5230, Vi 400, Vi 500, AD- 54, AD- 56	
68721420	38020769 	Duplex Registration Roller Tire Only Ribbed Tire	DC 5090, KM 4230, KM 5230, Vi 400, Vi 500, AD- 54, AD- 56	<i>Priced per Tire, sold in Bags of 10.</i>

For use in
Kyocera Mita
 Copiers









Central/Eastern Europe
 Telephone: 31(0)183-696969
 Fax: 31(0)183-629055
 E-mail: order@edc.katun.com







OEM PN	KATUN PN	DESCRIPTION	MODEL NO.	
Feed/Delivery				
57306400	38011549 	Original Pickup Roller	DC 5585, DC 5585 H, DC 5690, DC 7085, DC 7090	<i>Priced per Roller, sold in Bags of 2.</i>
57316190	38011368 	Original Feed Roller Unit Tire Only Crepe Tire	DC 5585 H, DC 5690, DC 7085, DC 7090	<i>Priced per Tire, sold in Bags of 9.</i>
57316191	38014698 	Original Feed Roller Unit Ribbed Tire	DC 5585 H, DC 5690, DC 7085, DC 7090	
57316191	38019854 	Original Feed Roller Unit Tire Only Ribbed Tire	DC 5585 H, DC 5690, DC 7085, DC 7090	<i>Priced per Tire, sold in Bags of 9.</i>
57306370	38011334 	Reverse Roller Unit Tire Only	DC 5585 H, DC 5690, DC 7085, DC 7090, RDH	<i>Priced per Tire, sold in Bags of 4.</i>
57316260	38015001 	Paper Feed Belt	DC 5585 H, DC 5690, DC 7085, DC 7090, RDH	<i>Priced per Belt, sold in Packages of 3.</i>
N/P/N	38011753 	Document Feeder Replacement Kit Kit Contains: • (6) Separation Belt • (4) Reverse Tire • (9) Original Feed Tire • (2) Original Pickup Roller	DC 5585 H, DC 5690, DC 7085, DC 7090, RDH	
N/P/N	38012139 	Document Feeder Replacement Kit Kit Contains: • (9) Original Feed Tire • (2) Original Pickup Roller • (6) Separation Belt	DC 5585 H, DC 5690, DC 7085, DC 7090, RDH	
63207540	38015781 	Separation Belt	DC 5590, DC 6590, DC 6595, DC 8090, DC 8095, Vi 300, RADF, RADF- 5, RADF- 6	<i>Priced per Belt, sold in Packages of 6.</i>
3AL07010	38020145 	Leading Feed Roller Tire Only	KM 4230, KM 5230, Vi 400, Vi 500, SRDF- 1	<i>Priced per Tire, sold in Bags of 10.</i>
3AL07020	38020146 	Paper Feed Roller Tire Only	KM 4230, KM 5230, Vi 400, Vi 500, SRDF- 1	<i>Priced per Tire, sold in Bags of 10.</i>
3AL07350	38020147 	Separation Roller Tire Only	KM 4230, KM 5230, Vi 400, Vi 500, SRDF- 1	<i>Priced per Tire, sold in Bags of 10.</i>

OEM PN	KATUN PN	DESCRIPTION	MODEL NO.	
Feed/Delivery				
N/P/N	38021751 	Feed Tire Replacement Kit Tire Only Kit Contains: • (1) Paper Feed Tire • (2) Paper Pickup Tire • (1) Separation Tire	KM 4230, KM 5230, Vi 400, Vi 500, SRDF- 1	
3BC07010	38022681 	Leading Feed Roller Tire Only Ribbed Tire	KM 4530, KM 5530, KM 6230, KM 6330, KM 7530, OMEGA D 630, SRDF- 2	<i>Priced per Tire, sold in Bags of 5.</i>
3BC07020	38022682 	Separation Roller Tire Only	KM 4530, KM 5530, KM 6230, KM 6330, KM 7530, OMEGA D 630, SRDF- 2	<i>Priced per Tire, sold in Bags of 10.</i>
5C314340	38019940 	Feed/Double Feed Prevention Roller Assy Tire Only	KM 8530, LT- 402, LT- 412, ST- 4000, ST- 4001	<i>Priced per Tire, sold in Bags of 10.</i>
5C314350	38019941 	Paper Feed Roller Assembly	KM 8530, LT- 402, LT- 412, ST- 4000, ST- 4001	<i>Priced per Feed/Sep Roller, sold in Bags of 10.</i>
25SA-4851	38020852 	Paper Feed Tire Four Feed Rollers with Shaft Pin	Vi 550, Vi 600	<i>Priced per Tire, sold in Bags of 4.</i>
5A814370	38016677 	Double Feed Prevention Tire Tire Only	Vi 550, Vi 600	<i>Priced per Tire, sold in Bags of 8.</i>
5A814500	38016268 	Paper Feed Tire A Tire Only	Vi 550, Vi 600	<i>Priced per Tire, sold in Bags of 10.</i>
5A826350	38018142 	Paper Pickup Tire Tire Only Ribbed Tire	Vi 550, Vi 600	<i>Priced per Tire, sold in Bags of 10.</i>
5A826520	38015378 	Paper Feed Tire Tire Only	Vi 550, Vi 600	<i>Priced per Tire, sold in Bags of 10.</i>
5A821360	38020760 	Torque Limiter	Vi 550, Vi 600, LT- 402, LT- 412, ST- 4000, ST- 4001	
5A909420	38022977 	Exit Roller	DF- 630, DF- 635, F- 8230, F- 8330	<i>Priced per Exit Roller, sold in Boxes of 2.</i>
4496-3001-02	38023398 	Paper Feed Roller Tire Only Ribbed Tire	PF- 620	<i>Priced per Tire, sold in Bags of 4.</i>
4496-3046-01	38023398 	Paper Pickup Roller Tire Only Ribbed Tire	PF- 620	<i>Priced per Tire, sold in Bags of 4.</i>

For use in
Kyocera Mita
 Copiers

Central/Eastern Europe
 Telephone: 31(0)183-696969
 Fax: 31(0)183-629055
 E-mail: order@edc.katun.com

OEM PN	KATUN PN	DESCRIPTION	MODEL NO.	
Feed/Delivery				
65707030	38015298 	Original Pickup Roller Tire Only	RADF, RADF- 5, RADF- 6	<i>Priced per Roller, sold in Bags of 10.</i>
65707050	38013139 	Original Feed Roller Tire Only	RADF, RADF- 5, RADF- 6	<i>Priced per Tire, sold in Bags of 10.</i>
50206570	38023916 	Separation Pad	RADF- 8	
50208140	38020979 	Original Feed Roller	RADF- 8	<i>Priced per Feed/Sep Roller, sold in Bags of 4.</i>
50208140	38011858 	Original Feed Roller Tire Only	RADF- 8	<i>Priced per Tire, sold in Bags of 4.</i>
4474-0217-04	38021495 	Separation Pad "Pad only"	RADF- 10	<i>Priced per Separation Pad, sold in Bags of 10.</i>
5BM07020	38016970 	Original Pickup Roller Tire Only	RADF- 10	<i>Priced per Tire, sold in Bags of 4.</i>
5BM07030	38021752 	Original Pickup Roller	RADF- 10	

OEM PN	KATUN PN	DESCRIPTION	MODEL NO.
Filters			
5C311820 <i>Final Inventory</i>	38021659 	Suction Filter	KM 8530
5A823040	38018380 	Ozone Filter	KM 8530, Vi 550, Vi 600
25SA-6940	38016792 	Dust Proof Filter Assembly	Vi 550, Vi 600
25SA62100	38016792 	Dust Proof Filter	Vi 550, Vi 600
540073071	38013832 	Toner Filter	Vi 550, Vi 600
5A823390	38013832 	Toner Filter	Vi 550, Vi 600

For use in
Kyocera Mita
 Copiers







Central/Eastern Europe
 Telephone: 31(0)183-696969
 Fax: 31(0)183-629055
 E-mail: order@edc.katun.com

OEM PN	KATUN PN	DESCRIPTION	MODEL NO.
Fuser Cleaning			
50306120	38017937	Fuser Cleaning Roller	Ci 7500, Ci 7600
50306740	38019439	Oil Application Roller	Ci 7500, Ci 7600
50306751	38018516	Oil Supply Roller	Ci 7500, Ci 7600
50346100	38018896	Oil Pickup Roller	Ci 7500, Ci 7600
77720041	38011219	Oil Supply Roller	DC 3555, DC 3585, DC 3755, DC 3785, DC 4555, DC 4585, DC 4585 F, DC 4655, DC 4685, DC 4685 F
36793371	38016671	Oil Roller	DC 5090, DC 6500
36793380 <i>Final Inventory</i>	38016929	Upper Fuser Cleaning Roller	DC 5090, DC 6500
61720421 <i>Final Inventory</i>	38011975	Upper Fuser Cleaning Roller FIBRA™ II Extended fuser component life.	DC 5590, DC 6090
61720431 <i>Final Inventory</i>	38017828	Lower Fuser Cleaning Roller	DC 5590, DC 6090, DC 6590, DC 6595, DC 8090, DC 8095
61720501 <i>Final Inventory</i>	38011974	Oil Roller	DC 5590, DC 6090, DC 6590, DC 6595, DC 8090, DC 8095
77620060	38010200	Oil Roller	DC 5655, DC 5660, DC 5685, DC 5690, DC 7085, DC 7090
77620091	38010508	Upper Fuser Cleaning Roller	DC 5655, DC 5660, DC 5685, DC 5690, DC 7085, DC 7090
77620091 <i>Final Inventory</i>	38021397	Upper Fuser Cleaning Roller	DC 5655, DC 5660, DC 5685, DC 5690, DC 7085, DC 7090
77620100	38632518	Lower Fuser Cleaning Roller	DC 5655, DC 5660, DC 5685, DC 5690, DC 7085, DC 7090
77620100	38021396	Lower Fuser Cleaning Roller	DC 5655, DC 5660, DC 5685, DC 5690, DC 7085, DC 7090
68320330 <i>Final Inventory</i>	38015512	Upper Fuser Cleaning Roller	DC 6590, DC 6595, DC 8090, DC 8095
78620240 <i>Final Inventory</i>	38011977	Oil Roller	DC 8585, DC 9285
78620250 <i>Final Inventory</i>	38011979	Fuser Cleaning Roller	DC 8585, DC 9285
2A020330	38019738	Web Supply Roller	KM 4530, KM 5530, KM 6230, KM 6330, KM 7530, OMEGA D 630



Katun Performance Product

© 2004 Katun Corporation

OEM PN	KATUN PN	DESCRIPTION	MODEL NO.
Fuser Cleaning			
2A020340	38020097 	Lower Fuser Cleaning Roller	KM 4530, KM 5530, KM 6230, KM 7530
5C314650	38019297 	Cleaning Web Assembly	KM 8530
2AR20570	38019868 	Fuser Cleaning Roller	Vi 230, Vi 230 L, Vi 310, Vi 310 L
5A817850	38017007 	Oil Pad	Vi 550, Vi 600
5A818250	38017527 	Oil Supply Roller	Vi 550, Vi 600
5A818340	38015652 	Upper Fuser Cleaning Roller	Vi 550, Vi 600



For use in
Kyocera Mita
Copiers

Central/Eastern Europe
Telephone: 31(0)183-696969
Fax: 31(0)183-629055
E-mail: order@edc.katun.com

OEM PN	KATUN PN	DESCRIPTION	MODEL NO.
Fuser Oil			
82220012	38019687 	Fuser Oil 1000 ml / Bottle	Ci 7500, Ci 7600

*Priced per Bottle,
sold in Boxes of 6.*

Central/Eastern Europe
Telephone: 31(0)183-696969
Fax: 31(0)183-629055
E-mail: order@edc.katun.com

For use in
Kyocera Mita
Copiers





OEM PN	KATUN PN	DESCRIPTION	MODEL NO.
-----------	-------------	-------------	--------------









Gears

5A812400	38019318 	Cleaner Idler Gear (18T)	Vi 550, Vi 600
----------	---	--------------------------	----------------

For use in
Kyocera Mita
 Copiers



Central/Eastern Europe
 Telephone: 31(0)183-696969
 Fax: 31(0)183-629055
 E-mail: order@edc.katun.com

OEM PN	KATUN PN	DESCRIPTION	MODEL NO.
Kits			
N/P/N	38015982 	Fuser Rebuild Kit Kit Contains: <ul style="list-style-type: none"> • (2) Upper Fuser Roller Bushing • (1) Upper Fuser Roller TRITON™ II • (1) Lower Pressure Roller MICROSLEEVE™ • (6) Fuser Picker Finger • (1) Fuser Roller Cleaning Blade 	AC 6500, DC 1555, DC 1605, DC 1656, DC 1657, DC 1685, DC 1855, DC 1856, DC 2155, DC 2355, DC 2556, DC 2557
N/P/N	38011753 	Document Feeder Replacement Kit Kit Contains: <ul style="list-style-type: none"> • (6) Separation Belt • (4) Reverse Tire • (9) Original Feed Tire • (2) Original Pickup Roller 	DC 5585 H, DC 5690, DC 7085, DC 7090, RDH
N/P/N	38012139 	Document Feeder Replacement Kit Kit Contains: <ul style="list-style-type: none"> • (9) Original Feed Tire • (2) Original Pickup Roller • (6) Separation Belt 	DC 5585 H, DC 5690, DC 7085, DC 7090, RDH
N/P/N	38021751 	Feed Tire Replacement Kit Tire Only Kit Contains: <ul style="list-style-type: none"> • (1) Paper Feed Tire • (2) Paper Pickup Tire • (1) Separation Tire 	KM 4230, KM 5230, Vi 400, Vi 500, SRDF- 1













OEM PN	KATUN PN	DESCRIPTION	MODEL NO.
Lamps			
42166521	38021185 	Exposure Lamp 170V 350W	DC 152 Z, DC 1655
73968030	38021200 	Exposure Lamp 170V 270W	DC 1205
29912040	38021186 	Exposure Lamp 170V 400W	DC 1255, DC 1455
60168020	38021159 	Exposure Lamp 170V 280W	DC 1415, DC 1435
60120250	38021091 	Heater Lamp 240V 1145W	DC 1415, DC 1435, DC 1455
75768030	38021155 	Exposure Lamp 170V 350W	DC 1555, DC 1605, DC 1656, DC 1657, DC 1685, DC 1855, DC 2155, DC 2556, DC 2557, DC 3055
67368120	38021165 	Exposure Lamp 170V 350W	DC 1556, DC 1755, DC 1856, DC 2355, DC 4056, DC 4086
75768150	38021083 	Heater Lamp 220V 850W	DC 1605, DC 1656, DC 1657, DC 1685, DC 1755, DC 1855
71968030	38021187 	Exposure Lamp 170V 300W	DC 3255, DC 3285

For use in
Kyocera Mita
 Copiers

Central/Eastern Europe
 Telephone: 31(0)183-696969
 Fax: 31(0)183-629055
 E-mail: order@edc.katun.com

OEM PN	KATUN PN	DESCRIPTION	MODEL NO.
Memory Upgrades			
19082120	38018413 	Memory Upgrade Board- 4 MB Copier Memory	Ai 1810 F, Vi 150, Vi 155, Vi 200, Vi 230, Vi 230 L, Vi 300, Vi 310, Vi 310 L
19082110	38018415 	Memory Upgrade Board- 2 MB Copier Memory	Ai 1810 F, Vi 150, Vi 155, Vi 200, Vi 230, Vi 230 L, Vi 310, Vi 310 L
19082130	38018414 	Memory Upgrade Board- 8 MB Copier Memory	Ai 1810 F, Vi 150, Vi 155, Vi 200, Vi 300











For current memory upgrade pricing, visit our on-line catalogue at www.katun.com or contact your customer service representative.









OEM PN	KATUN PN	DESCRIPTION	MODEL NO.
Photoreceptors			
82220011	38022274 	OPC Drum 6 Drums per Master Carton	Ci 7500, Ci 7600 <i>Priced per Drum, sold per Drum.</i>
58281100	38503135 	SeTe Drum 6 Drums per Master Carton	DC 111, DC 111 C, DC 114 <i>Priced per Drum, sold per Drum.</i>
83152000	38503138 	SeTe Drum 6 Drums per Master Carton	DC 152 Z, DC 1655, DC 1785, DC 2055, DC 2254, DC 2255, DC 2285 <i>Priced per Drum, sold per Drum.</i>
83513000	38507373 	As2Se3 Drum 6 Drums per Master Carton	DC 513 Z, DC 5055, DC 5555, DC 5585, DC 5585 H, DC 5655, DC 5660, DC 5685, DC 5690 <i>Priced per Drum, sold per Drum.</i>
83120500	38503141 	SeTe Drum 6 Drums per Master Carton	DC 1205, DC 1255, DC 1415, DC 1435, DC 1455 <i>Priced per Drum, sold per Drum.</i>
65882020	38013412	OPC Drum Original	DC 1215, DC 1256, DC 1260
19582030	38016684 	OPC Drum 20 Drums per Master Carton	DC 1460, DC 1470 <i>Priced per Drum, sold per Drum.</i>
19582030	38017075	OPC Drum Original	DC 1460, DC 1470
67382500	38000925 	OPC Drum 12 Drums per Master Carton	DC 1555, DC 1605, DC 1656, DC 1657, DC 1685, DC 1855, DC 2155, DC 2556, DC 2557, DC 3055, DC 4056, DC 4086 <i>Priced per Drum, sold per Drum.</i>
75782052	38000925 	OPC Drum 12 Drums per Master Carton	DC 1555, DC 1605, DC 1656, DC 1657, DC 1685, DC 1855, DC 2155, DC 2556, DC 2557, DC 3055, DC 4056, DC 4086 <i>Priced per Drum, sold per Drum.</i>
66082020	38016487 	OPC Drum 20 Drums per Master Carton	DC 1556, DC 1755 <i>Priced per Drum, sold per Drum.</i>
1AA82010	38015412 	OPC Drum 12 Drums per Master Carton	DC 1560, DC 1860, DC 2050, DC 2060, DC 2360, DC 2560 <i>Priced per Drum, sold per Drum.</i>
1AA82010	38015690	OPC Drum Original	DC 1560, DC 1860, DC 2050, DC 2060, DC 2360, DC 2560
66282020	38016487 	OPC Drum 20 Drums per Master Carton	DC 1856, DC 2355 <i>Priced per Drum, sold per Drum.</i>
33982010	38015393 	OPC Drum 12 Drums per Master Carton	DC 3060, DC 4060 <i>Priced per Drum, sold per Drum.</i>



For use in
Kyocera Mita
 Copiers















Central/Eastern Europe
 Telephone: 31(0)183-696969
 Fax: 31(0)183-629055
 E-mail: order@edc.katun.com

















OEM PN	KATUN PN	DESCRIPTION	MODEL NO.	
Photoreceptors				
71982030	38505351 	As2Se3 Drum 6 Drums per Master Carton	DC 3255, DC 3285, DC 3555, DC 3585, DC 3755, DC 3785, DC 4555, DC 4585, DC 4585 F, DC 4655, DC 4685, DC 4685 F	<i>Priced per Drum, sold per Drum.</i>
36782010	38018505	a-Si Drum Original	DC 5090, DC 6500	
83708500 <i>Final Inventory</i>	38505352 	As2Se3 Drum 6 Drums per Master Carton	DC 7085, DC 7090	<i>Priced per Drum, sold per Drum.</i>
78682010	38009132 	As2Se3 Drum 6 Drums per Master Carton	DC 8585, DC 9285	<i>Priced per Drum, sold per Drum.</i>
N/P/N	38022537 	OPC Drum 50 Drums per Master Carton	KM 1505, KM 1510, KM 1810	<i>Priced per Drum, sold per Drum.</i>
2AV82010	38021748 	OPC Drum 50 Drums per Master Carton	KM 1525, KM 1530, KM 2030	<i>Priced per Drum, sold per Drum.</i>
2AV82010	38022029	OPC Drum Original	KM 1525, KM 1530, KM 2030	
2AC82040	38018595 	OPC Drum 12 Drums per Master Carton	KM 4230, KM 5230, Vi 400, Vi 500	<i>Priced per Drum, sold per Drum.</i>
2BC82020	38022050	OPC Drum Access By Katun 12 Drums per Master Carton	KM 4530, KM 5530	<i>Priced per Drum, sold per Drum.</i>
2AR82020	38020777 	OPC Drum 50 Drums per Master Carton	Vi 230, Vi 310	<i>Priced per Drum, sold per Drum.</i>
2AR82020	38019849	OPC Drum Original	Vi 230, Vi 310	
2AR82080	38020778 	OPC Drum 100 K 50 Drums per Master Carton	Vi 230 L, Vi 310 L	<i>Priced per Drum, sold per Drum.</i>
18582030	38018595 	OPC Drum 12 Drums per Master Carton	Vi 300	<i>Priced per Drum, sold per Drum.</i>
82220105	38021515 	OPC Drum 12 Drums per Master Carton	Vi 550, Vi 600	<i>Priced per Drum, sold per Drum.</i>

OEM PN	KATUN PN	DESCRIPTION	MODEL NO.	
Picker Fingers				
28120470	38013100 	Picker Finger	AC 6500, DC 1555, DC 1556, DC 1560, DC 1605, DC 1656, DC 1657, DC 1685, DC 1755, DC 1855, DC 1856, DC 2050, DC 2155, DC 2355, DC 2556, DC 2557, DC 3055	<i>Priced per Picker Finger, sold in Packages of 10.</i>
43426601	38247060 	Upper Picker Finger	DC A2 F, DC 121, DC 122, DC 122 S, DC 131, DC 132, DC 133 R, DC 152 Z, DC 181 R, DC 211, DC 213 RE, DC 313 Z, DC 1655, DC 1785, DC 2105, DC 2555, DC 2585, DC 3255, DC 3285, DC 3555, DC 3585, DC 3755, DC 3785, DC 4555, DC 4585, DC 4585 F, DC 4655, DC 4685, DC 4685 F	<i>Priced per Picker Finger, sold in Packages of 10.</i>
42528100	38013100 	Picker Finger	DC 111, DC 111 C, DC 112, DC 112 C, DC 113, DC 114, DC 142 RE, DC 2055, DC 2254, DC 2255, DC 2285	<i>Priced per Picker Finger, sold in Packages of 10.</i>
29820380	38014608 	Picker Finger	DC 1001, DC 1205, DC 1255, DC 1405	<i>Priced per Picker Finger, sold in Packages of 6.</i>
61720750	38014643 	Upper Picker Finger B	DC 1860, DC 2060, DC 2360, DC 2560, DC 3060, DC 4056, DC 4060, DC 4086, DC 5590, DC 6090, DC 6590, DC 6595, DC 8090, DC 8095, KM 4530, KM 5530, KM 6230, KM 6330, KM 7530, OMEGA D 630, Vi 300, Vi 400, Vi 500	<i>Priced per Picker Finger, sold in Packages of 7.</i>
78620520	38015661 	Lower Picker Finger	DC 5590, DC 6090, DC 6590, DC 6595, DC 8090, DC 8095, DC 8585, DC 9285, Vi 300	<i>Priced per Picker Finger, sold in Bags of 10.</i>
5C311731	38019648 	Drum Picker Finger	KM 8530	<i>Priced per Picker Finger, sold in Bags of 3.</i>
5A817470	38013478 	Upper Picker Finger	Vi 550, Vi 600	<i>Priced per Set, 6 Picker Fingers per Set.</i>
5A817800	38014856 	Lower Picker Finger	Vi 550, Vi 600	<i>Priced per Set, 3 Picker Fingers per Set.</i>

For use in
Kyocera Mita
 Copiers

Central/Eastern Europe
 Telephone: 31(0)183-696969
 Fax: 31(0)183-629055
 E-mail: order@edc.katun.com















OEM PN	KATUN PN	DESCRIPTION	MODEL NO.
Rollers, Fuser/Heat			
65420090	38012578 	Upper Fuser Roller TRITON™ II Improved Toner Release Characteristics	AC 6500, DC 1555, DC 1605, DC 1656, DC 1657, DC 1685, DC 1855, DC 2055, DC 2155, DC 2254, DC 2255, DC 2285, DC 2556, DC 2557, DC 3055
65420090	38014841	Upper Fuser Roller Access By Katun	AC 6500, DC 1555, DC 1605, DC 1656, DC 1657, DC 1685, DC 1855, DC 2055, DC 2155, DC 2254, DC 2255, DC 2285, DC 2556, DC 2557, DC 3055
35993211	38018865 	Upper Fuser Roller	Ai 1810 F, Vi 150, Vi 155
50306071	38021504 	Upper Fuser Roller Silicone Based	Ci 7500, Ci 7600
43328110	38636395 	Upper Fuser Roller DURAPREM™ II	DC 111, DC 111 C
71620030	38636395 	Upper Fuser Roller DURAPREM™ II	DC 114
73920390	38636841 	Upper Fuser Roller DURAPREM™ II	DC 1205, DC 1255, DC 1415, DC 1435, DC 1455
73920390	38014842	Upper Fuser Roller Access By Katun	DC 1205, DC 1255, DC 1415, DC 1435, DC 1455
33220010	38012450 	Upper Fuser Roller OEM Type	DC 1215, DC 1260
65820070	38012450 	Upper Fuser Roller OEM Type	DC 1256
66220150	38012578 	Upper Fuser Roller TRITON™ II Improved Toner Release Characteristics	DC 1556, DC 1755, DC 1856, DC 2355
66220150	38014841	Upper Fuser Roller Access By Katun	DC 1556, DC 1755, DC 1856, DC 2355
34993201	38015858 	Upper Fuser Roller OEM Type	DC 1560, DC 1860, DC 2050, DC 2060, DC 2360, DC 2560
71820060	38010422 	Upper Fuser Roller DURACON™ II	DC 2555, DC 2585
33893101	38016687 	Upper Fuser Roller OEM Type	DC 3060
71920020	38010422 	Upper Fuser Roller DURACON™ II	DC 3255, DC 3285
64368410	38010422 	Upper Fuser Roller DURACON™ II	DC 3555, DC 3585, DC 3755, DC 3785, DC 4555, DC 4585, DC 4585 F, DC 4655, DC 4685, DC 4685 F
67320030	38012550 	Upper Fuser Roller DURACON™ II	DC 4056, DC 4086

OEM PN	KATUN PN	DESCRIPTION	MODEL NO.
Rollers, Fuser/Heat			
33920101	38015402 	Upper Fuser Roller OEM Type	DC 4060
36793350	38018539 	Upper Fuser Roller TRITON™ II	DC 5090, DC 6500
2A020010	38018539 	Upper Fuser Roller TRITON™ II	DC 5090, DC 6500, KM 6230, KM 6330, KM 7530, OMEGA D 630
61720411	38012316 	Upper Fuser Roller ALUMANA™ Patented TEFLON® coating with reinforcing oxides extends life.	DC 5590, DC 6090
61520010 <i>Final Inventory</i>	38016662 	Upper Fuser Roller ALUMANA™	DC 5655, DC 5660, DC 5685, DC 5690
68320141	38014751 	Upper Fuser Roller ALUMANA™ Patented TEFLON® coating with reinforcing oxides extends life.	DC 6590, DC 6595, DC 8090, DC 8095
77620270 <i>Final Inventory</i>	38016662 	Upper Fuser Roller ALUMANA™	DC 7085, DC 7090
2AV93071	38022141 	Upper Fuser Roller	KM 1525
2AV20100	38022141 	Upper Fuser Roller	KM 1525, KM 1530, KM 2030
2BK20012	38022893 	Upper Fuser Roller	KM 2530, KM 3530, KM 4030
2AC20370	38015402 	Upper Fuser Roller OEM Type	KM 4230, KM 5230, Vi 400, Vi 500
2BC20530	38023203 	Upper Fuser Roller TRITON™ II	KM 4530, KM 5530
5HA10050	38021654 	Upper Fuser Roller	KM 8530
2AB20380	38018865 	Upper Fuser Roller	Vi 200
2AR93122	38022032 	Upper Fuser Roller Access By Katun	Vi 230, Vi 230 L, Vi 310, Vi 310 L
5A818350	38014808 	Upper Fuser Roller TRITON™ II	Vi 550, Vi 600



For use in
Kyocera Mita
 Copiers















Central/Eastern Europe
 Telephone: 31(0)183-696969
 Fax: 31(0)183-629055
 E-mail: order@edc.katun.com

OEM PN	KATUN PN	DESCRIPTION	MODEL NO.
Rollers, Pressure			
75858592	38014104 	Lower Pressure Roller MICROSLEEVE™	AC 6500, DC 1555, DC 1605, DC 1656, DC 1657, DC 1685, DC 1855, DC 1856, DC 2055, DC 2155, DC 2254, DC 2255, DC 2285, DC 2355, DC 2556, DC 2557, DC 3055
75720122	38011324 	Lower Pressure Roller	AC 6500, DC 1555, DC 1605, DC 1656, DC 1657, DC 1685, DC 1855, DC 2055, DC 2155, DC 2254, DC 2255, DC 2285, DC 2355, DC 2556, DC 2557, DC 3055
2AB93040	38018322 	Lower Pressure Roller MICROSLEEVE™	Ai 1810 F, KM 1525, KM 1530, KM 2030, Vi 200
19593161	38021376 	Lower Pressure Roller MICROSLEEVE™	CC 60, DC 1460, DC 1470
50306081	38021505 	Lower Pressure Roller Silicone Based	Ci 7500, Ci 7600
72620210	38001050 	Lower Pressure Roller MICROSLEEVE™ PFA Sleeve extends life. A-Series Technology improves cleaning efficiency. with Ball Bearings	DC 152 Z, DC 1655, DC 1785
29720020	38001050 	Lower Pressure Roller MICROSLEEVE™ PFA Sleeve extends life. A-Series Technology improves cleaning efficiency. with Ball Bearings	DC 313 ZD
29820052	38636842 	Lower Pressure Roller	DC 1001, DC 1205, DC 1255, DC 1415, DC 1435, DC 1455
65820010	38016788 	Lower Pressure Roller	DC 1215, DC 1256, DC 1260
66068450	38013739 	Lower Pressure Roller MICROSLEEVE™ PFA Sleeve extends life.	DC 1556, DC 1560, DC 1755, DC 1860, DC 2050, DC 2060, DC 2360, DC 2560
66020100	38013739 	Lower Pressure Roller MICROSLEEVE™ PFA Sleeve extends life.	DC 1556, DC 1755
72120031	38014104 	Lower Pressure Roller MICROSLEEVE™	DC 2055, DC 2254, DC 2255, DC 2285
72120031	38011324 	Lower Pressure Roller	DC 2055, DC 2254, DC 2255, DC 2285
71820420	38001050 	Lower Pressure Roller MICROSLEEVE™ PFA Sleeve extends life. A-Series Technology improves cleaning efficiency. with Ball Bearings	DC 2555, DC 2585, DC 3255, DC 3285
33920660	38016733 	Lower Pressure Roller MICROSLEEVE™	DC 3060, DC 4060



Katun Performance Product

© 2004 Katun Corporation

OEM PN	KATUN PN	DESCRIPTION	MODEL NO.
Rollers, Pressure			
64368090	38001050 	Lower Pressure Roller MICROSLEEVE™ PFA Sleeve extends life. A-Series Technology improves cleaning efficiency. with Ball Bearings	DC 3555, DC 3585, DC 3755, DC 3785, DC 4555, DC 4585, DC 4585 F, DC 4655, DC 4685, DC 4685 F
72520160	38001050 	Lower Pressure Roller MICROSLEEVE™ PFA Sleeve extends life. A-Series Technology improves cleaning efficiency. with Ball Bearings	DC 4055, DC 4085
67320040	38001050 	Lower Pressure Roller MICROSLEEVE™ PFA Sleeve extends life. A-Series Technology improves cleaning efficiency. with Ball Bearings	DC 4056, DC 4086
36793361	38020956 	Lower Pressure Roller MICROSLEEVE™	DC 5090, DC 6500
74320051	38020964 	Lower Pressure Roller MICROSLEEVE™	DC 5555, DC 5585, DC 5585 H, DC 7085, DC 7090
68320190	38020964 	Lower Pressure Roller MICROSLEEVE™	DC 5590, DC 6590, DC 8090
61520020	38020964 	Lower Pressure Roller MICROSLEEVE™	DC 5655, DC 5660, DC 5685, DC 5690
61720450	38020964 	Lower Pressure Roller MICROSLEEVE™	DC 6090
2A193070	38021598 	Lower Pressure Roller MICROSLEEVE™	KM 1505, KM 1510, KM 1810
2BL20060	38022026 	Lower Pressure Roller MICROSLEEVE™	KM 2530, KM 3530, KM 4030
2AC20380	38018323 	Lower Pressure Roller MICROSLEEVE™	KM 4230, KM 5230, Vi 400, Vi 500
2BC20260	38018323 	Lower Pressure Roller MICROSLEEVE™	KM 4530, KM 5530, KM 6330, OMEGA D 630
2AR93130	38019295 	Lower Pressure Roller MICROSLEEVE™	Vi 230, Vi 230 L, Vi 310, Vi 310 L
18593271 <i>Final Inventory</i>	38019296 	Lower Pressure Roller MICROSLEEVE™	Vi 300
5A818260	38020960 	Lower Pressure Roller MICROSLEEVE™	Vi 550, Vi 600

For use in
Kyocera Mita
Copiers

Central/Eastern Europe
Telephone: 31(0)183-696969
Fax: 31(0)183-629055
E-mail: order@edc.katun.com

OEM PN	KATUN PN	DESCRIPTION	MODEL NO.
Seals			
75768080	38011980 	Cleaning Unit Lower Seal Assembly	DC 1555, DC 1605, DC 1656, DC 1657, DC 1685, DC 1855, DC 2155

Central/Eastern Europe
Telephone: 31(0)183-696969
Fax: 31(0)183-629055
E-mail: order@edc.katun.com

For use in
Kyocera Mita
Copiers

OEM PN	KATUN PN	DESCRIPTION	MODEL NO.
-----------	-------------	-------------	--------------

Springs

72916070	38524654 	Corona Wire Spring Stainless Steel Transfer, Separation Transfer	CC 10, CC 20, CC 50 DC 1215, DC 1256, DC 1260	<i>Priced per Spring, sold in Bags of 10.</i>
----------	---	--	--	---





For use in
Kyocera Mita
Copiers

Central/Eastern Europe
Telephone: 31(0)183-696969
Fax: 31(0)183-629055
E-mail: order@edc.katun.com

OEM PN	KATUN PN	DESCRIPTION	MODEL NO.
-----------	-------------	-------------	--------------





Thermal Control Devices









5A817700	38021691 	Upper Thermoswitch	Vi 550, Vi 600
----------	---	--------------------	----------------

OEM PN	KATUN PN	DESCRIPTION	MODEL NO.
Toners/Toner Cartridges			
37092010	38019185	Black Toner Original 190 g / Cartridge	Ai 1810 F, Vi 150, Vi 155, Vi 200
37079010	38013443	Black Toner Original 50 g / Cartridge	CC 30, CC 35
37082010	38013384	Black Toner Original 105 g / Cartridge	CC 50, CC 55
37082010	38015295	Black Toner Access By Katun 105 g / Cartridge 30 Cartridges per Master Carton	CC 50, CC 55 <i>Priced per Cartridge, sold per Cartridge.</i>
37007010	38019611	Black Toner Access By Katun 100 g / Cartridge 10 Cartridges per Master Carton	CC 60 <i>Priced per Cartridge, sold per Cartridge.</i>
37002259	38808146 	Black Toner 90 g / Cartridge 10 Cartridges per Master Carton	DC 111, DC 111 C <i>Priced per Cartridge, sold per Cartridge.</i>
37001612 <i>Final Inventory</i>	38808101 	Black Toner 300 g / Bottle 10 Bottles per Master Carton	DC 121, DC 122, DC 122 S, DC 131, DC 132, DC 133 R <i>Priced per Bottle, sold per Bottle.</i>
37002812	38808130 	Black Toner 150 g / Cartridge 12 Boxes (24 Cartridges) per Master Carton	DC 152 Z, DC 1655, DC 1785 <i>Priced per Cartridge, sold in Boxes of 2.</i>
37001518 <i>Final Inventory</i>	38808101 	Black Toner 300 g / Bottle 10 Bottles per Master Carton	DC 161, DC 162, DC 232 <i>Priced per Bottle, sold per Bottle.</i>
37002112	38808112 	Black Toner 150 g / Cartridge 12 Boxes (24 Cartridges) per Master Carton	DC 211, DC 213 RE, DC 313 Z, DC 313 ZD, DC 2105 <i>Priced per Cartridge, sold in Boxes of 2.</i>
37041085	38807838 	Black Toner 65 g / Cartridge 24 Cartridges per Master Carton	DC 1205, DC 1255 <i>Priced per Cartridge, sold per Cartridge.</i>
37041085	38013345	Black Toner Original 65 g / Cartridge	DC 1205, DC 1255
37068010	38017242 	Black Toner 88 g / Cartridge 24 Cartridges per Master Carton	DC 1215, DC 1256, DC 1260 <i>Priced per Cartridge, sold per Cartridge.</i>
37068010	38013458	Black Toner Original 88 g / Cartridge	DC 1215, DC 1256, DC 1260

For use in
Kyocera Mita
 Copiers









Central/Eastern Europe
 Telephone: 31(0)183-696969
 Fax: 31(0)183-629055
 E-mail: order@edc.katun.com

OEM PN	KATUN PN	DESCRIPTION	MODEL NO.
Toners/Toner Cartridges			
37054010	38010550 	Black Toner 65 g / Cartridge 24 Cartridges per Master Carton	DC 1415, DC 1435, DC 1455 <i>Priced per Cartridge, sold per Cartridge.</i>
37054010	38013344	Black Toner Original 65 g / Cartridge	DC 1415, DC 1435, DC 1455
37098010	38020400 	Black Toner 220 g / Cartridge 40 Cartridges per Master Carton	DC 1460, DC 1470 <i>Priced per Cartridge, sold per Cartridge.</i>
37098010	38016980	Black Toner Original 240 g / Cartridge	DC 1460, DC 1470
37057010	38807899 	Black Toner 180 g / Cartridge 12 Boxes (24 Cartridges) per Master Carton	DC 1555, DC 1855, DC 2155 <i>Priced per Cartridge, sold in Boxes of 2.</i>
37057010	38013453	Black Toner Original 180 g / Cartridge	DC 1555, DC 1855, DC 2155 <i>Priced per Cartridge, sold in Boxes of 2.</i>
37075010	38015821	Black Toner Access By Katun 111 g / Cartridge 16 Boxes (32 Cartridges) per Master Carton	DC 1556 <i>Priced per Cartridge, sold in Boxes of 2.</i>
37075011	38014332	Black Toner Original 111 g / Cartridge	DC 1556 <i>Priced per Cartridge, sold in Boxes of 2.</i>
37090009	38019723 	Black Toner 205 g / Cartridge	DC 1560, DC 1860, DC 2050, DC 2060, DC 2360, DC 2560 <i>Priced per Cartridge, sold in Boxes of 2.</i>
37090009	38015658	Black Toner Original 205 g / Cartridge	DC 1560, DC 1860, DC 2050, DC 2060, DC 2360, DC 2560 <i>Priced per Cartridge, sold in Boxes of 2.</i>
37090009	38018358	Black Toner Access By Katun 205 g / Cartridge 16 Boxes (32 Cartridges) per Master Carton	DC 1560, DC 1860, DC 2050, DC 2060, DC 2360, DC 2560 <i>Priced per Cartridge, sold in Boxes of 2.</i>
37046010	38807899 	Black Toner 180 g / Cartridge 12 Boxes (24 Cartridges) per Master Carton	DC 1605, DC 1656, DC 1657, DC 1685 <i>Priced per Cartridge, sold in Boxes of 2.</i>
37046010	38013653	Black Toner Original 180 g / Cartridge	DC 1605, DC 1656, DC 1657, DC 1685 <i>Priced per Cartridge, sold in Boxes of 2.</i>
37084010	38014623 	Black Toner 180 g / Cartridge 12 Boxes (24 Cartridges) per Master Carton	DC 1755 <i>Priced per Cartridge, sold in Boxes of 2.</i>

OEM PN	KATUN PN	DESCRIPTION	MODEL NO.	
Toners/Toner Cartridges				
37077010	38014333	Black Toner Original 190 g / Bottle	DC 1856, DC 2355	<i>Priced per Bottle, sold in Boxes of 2.</i>
37077010	38015822	Black Toner Access By Katun 190 g / Cartridge 16 Boxes (32 Cartridges) per Master Carton	DC 1856, DC 2355	<i>Priced per Cartridge, sold in Boxes of 2.</i>
37037085	38807841 	Black Toner 200 g / Cartridge 12 Boxes (24 Cartridges) per Master Carton	DC 2055, DC 2254, DC 2255, DC 2285	<i>Priced per Cartridge, sold in Boxes of 2.</i>
37037085	38013652	Black Toner Original 200 g / Cartridge	DC 2055, DC 2254, DC 2255, DC 2285	<i>Priced per Cartridge, sold in Boxes of 2.</i>
37040010	38807843 	Black Toner 200 g / Cartridge 24 Cartridges per Master Carton	DC 2555, DC 2585, DC 3255, DC 3285	<i>Priced per Cartridge, sold per Cartridge.</i>
37058010	38012836 	Black Toner 250 g / Cartridge 12 Boxes (24 Cartridges) per Master Carton	DC 2556, DC 2557, DC 3055	<i>Priced per Cartridge, sold in Boxes of 2.</i>
37058010	38013660	Black Toner Original 250 g / Cartridge	DC 2556, DC 2557, DC 3055	<i>Priced per Cartridge, sold in Boxes of 2.</i>
37085010	38019722 	Black Toner 550 g / Cartridge 10 Cartridges per Master Carton	DC 3060, DC 4060	<i>Priced per Cartridge, sold per Cartridge.</i>
37085010	38015657	Black Toner Original 550 g / Cartridge	DC 3060, DC 4060	
37085010	38018565	Black Toner Access By Katun 550 g / Cartridge 12 Cartridges per Master Carton	DC 3060, DC 4060	<i>Priced per Cartridge, sold per Cartridge.</i>
37056010	38011961 	Black Toner 400 g / Cartridge 12 Cartridges per Master Carton	DC 3555, DC 3585	<i>Priced per Cartridge, sold per Cartridge.</i>
37064010	38011961 	Black Toner 400 g / Cartridge 12 Cartridges per Master Carton	DC 3755, DC 3785	<i>Priced per Cartridge, sold per Cartridge.</i>
37033010	38807840 	Black Toner 200 g / Cartridge 12 Boxes (24 Cartridges) per Master Carton	DC 4055, DC 4085	<i>Priced per Cartridge, sold in Boxes of 2.</i>
37071010	38013148 	Black Toner 425 g / Cartridge 12 Cartridges per Master Carton	DC 4056, DC 4086	<i>Priced per Cartridge, sold per Cartridge.</i>

For use in
Kyocera Mita
 Copiers

Central/Eastern Europe
 Telephone: 31(0)183-696969
 Fax: 31(0)183-629055
 E-mail: order@edc.katun.com

OEM PN	KATUN PN	DESCRIPTION	MODEL NO.
Toners/Toner Cartridges			
37071010	38013447	Black Toner Original 425 g / Cartridge	DC 4056, DC 4086
37050085	38011961 	Black Toner 400 g / Cartridge 12 Cartridges per Master Carton	DC 4555, DC 4585, DC 4585 F
37061010	38011961 	Black Toner 400 g / Cartridge 12 Cartridges per Master Carton	DC 4655, DC 4685, DC 4685 F
37095010	38018503	Black Toner Original 1050 g / Cartridge	DC 5090
37042010	38010024 	Black Toner 500 g / Bottle 12 Boxes (24 Bottles) per Master Carton	DC 5555, DC 5585, DC 5585 H
37066010	38013448	Black Toner Original 1500 g / Cartridge	DC 5590, DC 6090
37059010	38012654 	Black Toner 800 g / Cartridge 12 Cartridges per Master Carton	DC 5655, DC 5660, DC 5685, DC 5690, DC 7090
37048080	38009135 	Black Toner 550 g / Bottle 12 Boxes (24 Bottles) per Master Carton	DC 7085
37029010	38023154 	Black Toner 300 g / Cartridge • (1) Waste Toner Bottle 20 Cartridges per Master Carton	KM 1505, KM 1510, KM 1810
37028000	38023152 	Black Toner 450 g / Cartridge • (1) Waste Toner Bottle 15 Cartridges per Master Carton	KM 1525, KM 1530, KM 2030
37028000	38022027	Black Toner Original 450 g / Cartridge	KM 1525, KM 1530, KM 2030
37015010	38019705	Black Toner Original 700 g / Cartridge	KM 4230, KM 5230, Vi 400, Vi 500
37016010	38023156 	Black Toner 315 g / Cartridge 20 Cartridges per Master Carton	Vi 230, Vi 230 L, Vi 310, Vi 310 L
37016010	38019189	Black Toner Original 315 g / Cartridge	Vi 230, Vi 230 L, Vi 310, Vi 310 L

*Priced per Cartridge,
 sold per Cartridge.*

*Priced per Cartridge,
 sold per Cartridge.*

*Priced per Bottle,
 sold in Boxes of 2.*

*Priced per Cartridge,
 sold per Cartridge.*

*Priced per Bottle,
 sold in Boxes of 2.*

*Priced per Cartridge,
 sold per Cartridge.*

*Priced per Cartridge,
 sold per Cartridge.*

*Priced per Cartridge,
 sold per Cartridge.*

Central/Eastern Europe
Telephone: 31(0)183-696969
Fax: 31(0)183-629055
E-mail: order@edc.katun.com

For use in
Kyocera Mita
Copiers

OEM PN	KATUN PN	DESCRIPTION	MODEL NO.
-----------	-------------	-------------	--------------

Toners/Toner Cartridges

37016010	38022934	Black Toner Access By Katun 315 g / Cartridge 10 Cartridges per Master Carton	Vi 230, Vi 230 L, Vi 310, Vi 310 L	<i>Priced per Cartridge, sold per Cartridge.</i>
----------	----------	--	------------------------------------	--

For use in
Kyocera Mita
Copiers

Central/Eastern Europe
Telephone: 31(0)183-696969
Fax: 31(0)183-629055
E-mail: order@edc.katun.com

OEM PN	KATUN PN	DESCRIPTION	MODEL NO.
-----------	-------------	-------------	--------------

Waste Toner Containers

79568070 <i>Final Inventory</i>	38014147 	Waste Toner Bottle	DC 1555, DC 1855, DC 2155
75700720 <i>Final Inventory</i>	38014147 	Waste Toner Bottle	DC 1605, DC 1656, DC 1657

General Information

Credit Terms and Ordering Information

Credit Terms

Standard credit terms are net-30-days from date of invoice. To open a net-30-day account, please contact the Katun Credit Department. Until your credit application is approved, orders will be shipped upon receipt of cash in advance or a confirmed, Sight Draft, or via C.O.D. (Nominal C.O.D. handling charges will apply.)

Katun offers a 3% cash-with-order (CWO) discount. Katun will calculate the 3% discount, promptly inform you of the total charges, and ship your order immediately upon receipt of your payment.

Place all orders with Katun (E.D.C.) B.V. via:

- Telephone: 31(0) 183–696969
- Fax: 31(0) 183–629055
- E-mail: order@edc.katun.com
- Address:

Katun (E.D.C.) B.V.
Edisonweg 44
4207 HG Gorinchem
The Netherlands

Reference Katun part numbers on all orders.

Prices are in Euro, EX WORKS Gorinchem, The Netherlands.

Katun business hours are from 8:30 to 17.00 hours.

Katun has a € 350 minimum order. A € 35 charge will be added to orders under the minimum.

Wire transfer funds to:

ABN–AMRO Bank
Daalsesingel 71
Postbus 2059
3500 GB Utrecht
The Netherlands
Account Number: 55 70 74 134
Swift I.D.: ABN ANL 2A
IBAN: NL51ABNA0557074134

General Shipping Information and Product Return Policies

Shipping and Handling

Katun can provide you with alternatives for shipping. We will attempt to select the most convenient and cost-effective carrier for you. However, if you have a preferred carrier, please inform your Katun Customer Service Representative.

Central/Eastern Europe

Telephone: 31(0)183-696969

Fax: 31(0)183-629055

E-mail: order@edc.katun.com

Hazardous material shipments will be billed accordingly. A nominal handling charge is incorporated into our shipping costs.

Product Return Policies

- Katun **must** preauthorize all returns. For return procedures and a return, contact the Customer Service Department at 31(0) 183–696969.
- Toner, toner cartridges, digital duplicator inks and masters, and thermal transfer ribbons with personalized labels cannot be returned to Katun for credit unless a valid warranty claim exists.
- Returns and refused shipments are subject to a minimum 10% restocking charge.
- With the exception of warranty claims, merchandise returned more than 90 days from the invoice date will not be accepted.
- Merchandise which has been written on, marked, relabeled, or placed in other than original Katun packaging will not be accepted.
- All warranty claims submitted to Katun *must* be accompanied by a completed Distributor Choice Warranty Claim Form (included in this catalog). Customers must indicate a warranty choice on the form:
 - (a) Technical Evaluation/ Replacement or technical Evaluation/ Credit: Ship the product and the completed form to:

Katun (E.D.C.) B.V.
Edisonweg 44
4207 HG
Gorinchem
The Netherlands
 - (b) Automatic Replacement: send the completed form to your customer service representative.



Allgemeine Hinweise

Zahlungsbedingungen und Bestellinformationen

Die übliche Zahlungsweise ist bar innerhalb von 30 Tagen ab Rechnungsdatum. Zur Eröffnung eines Kontos wenden Sie sich bitte an die Katun Kreditabteilung. Bis zur Gewährung Ihres Kredits erfolgt der Versand von Bestellungen bei Vorkasse oder bei Erhalt eines bestätigten, Sichtwechsel oder gegen Nachnahme (unter Berechnung einer geringen Nachnahmegebühr).

Katun gewährt 3 % Skonto für Barzahlung bei Bestellung. Katun wird den Skontobetrag errechnen, Ihnen den Gesamtbetrag mitteilen und Ihre Bestellung unverzüglich nach Erhalt Ihrer Zahlung zum Versand aufgeben.

Bitte richten Sie alle Bestellungen an Katun (E.D.C.) B.V. unter:

- **Telefon: 31 (0) 183–696969**
- **Fax: 31 (0) 183–629055**
- **E-mail: order@edc.katun.com**
- **Adresse:**

Katun (E.D.C.) B.V.
Edisonweg 44
NL-4207 HG Gorinchem
Niederlande

Bitte bei allen Bestellungen die Katun Artikelnummern angeben. Preise verstehen sich in Euro, ab Werk Gorinchem, Niederlande.

Katun Geschäftszeit ist 8.30 - 17.00 Uhr. Für alle Bestellungen gilt ein Mindestbestellwert von € 350. Bei Bestellungen unter dem Mindestbestellwert wird ein Zuschlag von €35 berechnet.

Bankverbindung:

ABN AMRO Bank
Daalsesingel 71
Postbus 2059
NL-3500 GB Utrecht
Niederlande
Kontonummer: 55 70 74 134
Bankleitzahl: ABN ANL 2A
IBAN: NL51ABNA0557074134

Versand und Warenrücksendung

Bearbeitung und Versand

Katun bietet verschiedene Versandmethoden an. Wir bemühen uns, die für Sie günstigste und praktischste Versandart zu wählen. Falls Sie eine bestimmte Versandart/Firma vorziehen, teilen Sie dies bitte Ihrem Katun Repräsentanten mit.

Central/Eastern Europe

Telephone: 31(0)183-696969

Fax: 31(0)183-629055

E-mail: order@edc.katun.com

Versandkosten für Gefahrgüter werden entsprechend berechnet. Eine geringe Bearbeitungsgebühr ist in unseren Versandgebühren enthalten.

Warenrücksendung

- Nur von Katun vorher genehmigte Waren- rücksendungen könnenbearbeitet werden. Bitte lassen Sie sich vom Kundendienst unter der Telefonnummer 31 (0) 183-696969 genaue Anweisungen geben.
- Bei Warenrücksendungen werden 10 % Rücknahmegebühren in Abzug gebracht.
- Toner, Drucker-/Faxkartuschen, Tinten für digitale Duplikatoren sowie Thermo-Transfer-Bänder mit Firmenetiketten sind vom Umtausch ausgeschlossen, es sei denn, es liegt ein Garantiefall for.
- Ware, die nach Ablauf von 90 Tagen ab Rechnungsdatum zurückgeschickt wird, kann nicht zurückgenommen werden (mit Ausnahme von Reklamationen).
- Ware, deren Verpackung markiert, etikettiert oder beschriftet wurde, oder Ware ohne Originalverpackung kann nicht zurückgenommen werden.
- Alle Garantieansprüche müssen von einem ausgefüllten Händler -Garantieformular begleitet sein (Formular in diesem Katalog enthaltrn). Geben Sie Ihren Regulierungswunsch auf dem Formular an:
 - (a) Technische Bewertung/Ersatz oder Technische Bewertung/Gutschrift: schicken Sie das Produkt und das vollständig ausgefüllte Formular an:

Katun (E.D.C.) B.V.
Edisonweg 44
NL-4207 HG Gorinchem
Niederlande
 - (b) Ersatz ohne Bewertung: schicken Sie das vollständig ausgefüllte Formular an Ihren Ansprechpartner der Auftragsbearbeitung.

DISTRIBUTOR CHOICE WARRANTY CLAIM FORM

Please print all information. For prompt processing of your claim, please complete all sections. Your feedback is important to the ongoing improvement of Katun products. Thank you.

I. WARRANTY CHOICE

Please check one. See Section 2 on reverse side for additional information.

Technical Evaluation/Replacement Technical Evaluation/Credit Automatic Replacement

II. CUSTOMER INFORMATION

Customer Number: _____ Date Shipped: _____

Company Name: _____ Delivery Date: _____

Address: _____

City: _____ State/Province: _____

Country: _____ Postal Code: _____

Your Name: _____ Title: _____

III. PRODUCT INFORMATION

Katun PN	Quantity	Description	Serial/Lot Number
1) _____	_____	_____	_____
2) _____	_____	_____	_____
3) _____	_____	_____	_____
4) _____	_____	_____	_____
5) _____	_____	_____	_____

IV. DETAILED REASON(S) FOR CLAIM

Provide specific information for each product claimed, explaining the reason for claim in as much detail as possible. Include machine models, machine log information, and copy/print counts. **See Section 3 on reverse side for additional specific requirements for photoreceptors.**

- 1) _____
- 2) _____
- 3) _____
- 4) _____
- 5) _____

FOR KATUN USE ONLY

Product Warranty Claim No.: _____ Pieces: _____
Received By: _____ Date: _____

Central/Eastern Europe

Telephone: 31(0)183-696969

Fax: 31(0)183-629055

E-mail: order@edc.katun.com

PLEASE READ AND COMPLY WITH ALL THESE REQUIREMENTS TO EXPEDITE THE PROCESSING OF YOUR CLAIM.

1. General Instructions

A completed copy of this form must accompany all product warranty claims. Please indicate date of product delivery for determination of warranty coverage time period. *Your feedback is important to the ongoing improvement of Katun products. Please complete all sections on the reverse side.*

2. Distributor Choice Warranty Claim Options

Please indicate your choice of Technical Evaluation/Replacement, Technical Evaluation/Credit, or Automatic Replacement. **NOTE:** Automatic Replacement claims must be filed within 90 days of product delivery date, and must not exceed US\$500/€ 550.

If no choice is indicated:

- (a) If product is included with this form, this claim will be treated as Technical Evaluation/Replacement.
- (b) If no product is included with this form, and the claim is less than US\$500/€ 550, this claim will be treated as Automatic Replacement.
- (c) If no product is included with this form, and the claim is more than US\$500/€ 550, the claim is invalid.

3. Specific Requirements

If damage (for example, a chip or scratch on a photoreceptor) is noted "out-of-box," DO NOT INSTALL THE PRODUCT. No copy/print samples are required. Installing a product with out-of-box damage could void the warranty.

Include applicable copy/print samples with all claims. If a photoreceptor is suspected to be defective after machine installation, please attach to this form the copy/print samples indicated below. This will allow a thorough evaluation of the claim. Ensure that neither the form nor copy/print samples will contact the photoreceptor surface during shipment.

FOR PHOTORECEPTORS USED IN COPIERS, include:

- (a) Three "sky shot" (open platen; black) copies;
- (b) Three white copies; and
- (c) Three copies of a test pattern.

NOTE: If the defect is not visible on the copies indicated above, please attach three copies which clearly show the defect.

FOR PHOTORECEPTORS USED IN PRINTERS AND PLAIN PAPER FACSIMILES, include three prints which clearly show the defect.

IMPORTANT: The Katun product warranty does not cover damage by operator, technician, or machine (including rotational scratches, gouges, scuff marks, or line scratches).

4. Shipping Instructions

ALL PRODUCT RETURNS MUST BE PROPERLY PACKAGED. This includes packaging in the correct individual product box and in a second container with adequate protective packaging material. This is required by all carriers.

NOTE: Products damaged in transit to Katun due to inadequate packaging cannot be covered by the Katun product warranty, and will be returned.

Ship Technical Evaluation claims, freight prepaid, to the address specifically indicated for this purpose in the "General Information" section of the Katun On-Line Catalogue and current printed catalogues. Katun cannot accept responsibility for product warranty claims sent to any other address. **Send Automatic Replacement Claims to your Katun Customer Service Representative.**

HÄNDLER-GARANTIEFORMULAR

Das Formular bitte in Druckschrift ausfüllen. Um eine umgehende Bearbeitung Ihrer Reklamation zu ermöglichen, tragen Sie bitte alle Angaben ein.

Ihr Feedback trägt zur weiteren Verbesserung von Katun-Produkten bei. Vielen Dank.

I. REGULIERUNGSWUNSCH

Bitte nur einen ankreuzen. Weitere Informationen finden Sie in Abschnitt 2 auf der Rückseite.

Technische Bewertung/Ersatz Technische Bewertung/Gutschrift Ersatz ohne Bewertung

II. KUNDENINFORMATIONEN

Kunden-Nr.: _____ Versanddatum: _____

Firmenname: _____ Lieferdatum: _____

Straße: _____

Postleitzahl: _____ Ort: _____

Land: _____

Ihr Name: _____ Titel/Funktion: _____

III. PRODUKTINFORMATIONEN

Katun-Artikel-Nr.	Menge	Bezeichnung	Serien-/Lotnummer
1) _____	_____	_____	_____
2) _____	_____	_____	_____
3) _____	_____	_____	_____
4) _____	_____	_____	_____
5) _____	_____	_____	_____

IV. AUS WELCHEM GRUND REKLAMIEREN SIE DIE WARE?

Machen Sie bitte zu jedem reklamierten Artikel so ausführliche und genaue Angaben wie möglich. Des weiteren benötigen wir Angaben zum Gerätemodell, eine Kopie des Bordbuches sowie Informationen bezüglich der Anzahl der erstellten Kopien/Ausdrucke des Produktes. **Bitte beachten Sie Punkt 3 auf der Rückseite mit wichtigen Informationen zur Reklamation von Fotorezeptoren.**

1) _____

2) _____

3) _____

4) _____

5) _____

NUR FÜR DEN INTERNEN GEBRAUCH

Reklamations-Nr.: _____ Stückzahl: _____

Entgegengenommen von: _____ Eingangsdatum: _____

Central/Eastern Europe

Telephone: 31(0)183-696969

Fax: 31(0)183-629055

E-mail: order@edc.katun.com

BITTE BEACHTEN SIE FOLGENDE HINWEISE, UM DIE BEARBEITUNG IHRER REKLAMATION ZU BESCHLEUNIGEN.

1. Allgemeine Hinweise

Verwenden Sie diesen Mängelbericht bei allen Reklamationen. Geben Sie zur Bestimmung der Garantiefrist bitte das Lieferdatum des Produktes an. *Ihr Feedback trägt zur weiteren Verbesserung von Katun-Produkten bei. Bitte tragen Sie alle Angaben auf der Rückseite vollständig ein.*

2. Händler-Garantieoption

Geben Sie bitte Ihren Regulierungswunsch an (Technische Bewertung/Ersatz, Technische Bewertung/Gutschrift oder Ersatz ohne Bewertung.) **BITTE BEACHTEN:** Reklamationen ohne Bewertung müssen innerhalb von 90 Tagen nach dem Lieferdatum des Produktes geltend gemacht werden und dürfen einen Wert von USD 500/Euro 550 nicht überschreiten.

Wenn keine Wahl getroffen wurde:

- (a) Wenn diesem Formular das Produkt beigelegt wurde, wird diese Reklamation als Technische Bewertung/Ersatz bearbeitet.
- (b) Wenn diesem Formular kein Produkt beigelegt wurde und der Wert der Reklamation weniger als USD 500/ Euro 550 beträgt, wird diese Reklamation als Ersatz ohne Bewertung bearbeitet.
- (c) Wenn diesem Formular kein Produkt beigelegt wurde und der Wert der Reklamation mehr als USD 500/ Euro 550 beträgt, besteht kein Anspruch auf Reklamation.

3. Spezielle Anforderungen

Wenn Schäden (z.B. Splitter oder Kratzer an einem Fotorezeptor) bereits „beim Auspacken“ festgestellt werden, dann **INSTALLIEREN SIE DAS PRODUKT NICHT.** Testkopien sind nicht erforderlich. Die Installation eines Produktes mit bereits bestehendem Schaden könnte zum Erlöschen Ihrer Garantiesprüche führen.

Fügen Sie allen Reklamationen entsprechende Testkopien bei. Wenn ein Fotorezeptor nach der Installation einen Defekt aufzuweisen scheint, legen Sie diesem Formular bitte die nachstehend beschriebenen Testkopien bei, um eine genaue Beurteilung der Mängel zu ermöglichen. Das Formular sowie die Testkopien dürfen bei der Rücksendung auf keinen Fall mit der Oberfläche des Fotorezeptors in Berührung kommen.

FÜR FOTOREZEPTOREN, DIE IN KOPIERERN BENUTZT WURDEN, folgende Testkopien beilegen:

- (a) 3 schwarze Kopien (bei offener Vorlagenglas-Abdeckung),
- (b) 3 weiße Kopien und
- (c) 3 Testkopien (vom Testbogen).

BITTE BEACHTEN: Ist der Defekt auf diesen Mustern nicht sichtbar, legen Sie bitte 3 Kopien bei, auf denen er deutlich zu erkennen ist.

FÜR FOTOREZEPTOREN, DIE IN DRUCKERN UND NORMALPAPIER-FAXGERÄTEN BENUTZT WURDEN, legen Sie bitte 3 Kopien bei, auf denen der Defekt deutlich zu erkennen ist.

WICHTIG: Schäden, die durch falsche Bedienung des Endanwenders, durch den Techniker oder das Gerät verursacht wurden (d. h. umlaufende Kratzer, Streifen, Abrieb oder querlaufende Kratzer), sind von der Katun Qualitätsgarantie ausgeschlossen.

4. Versandrichtlinien

ALLE TEILE, DIE AN UNS ZURÜCKGESANDT WERDEN, MÜSSEN SACHGEMÄSS VERPACKT SEIN, d. h. in dem entsprechenden Einzelkarton und einem zweiten Karton mit entsprechendem Verpackungsmaterial. Dies betrifft jeglichen Transportweg!

BITTE BEACHTEN: Teile, die nicht sachgemäß verpackt werden und uns aus diesem Grunde defekt erreichen, sind von der Katun-Qualitätsgarantie ausgeschlossen und werden nicht angenommen.

Schicken Sie Ihre Reklamation zur technischen Bewertung (frachtfrei) an die für diese Zwecke im Katun-Online-Katalog und dem gültigen regulären Katalog unter den „allgemeinen Hinweisen“ angegebene Adresse. Katun übernimmt keinerlei Verantwortung für Reklamationen, die an eine andere Adresse als die oben genannte geschickt werden. **Schicken Sie Reklamation zum Ersatz ohne Bewertung an Ihren Katun-Ansprechpartner.**

