

Katun Products for use in
Panasonic

Table of Contents

	<i>Page</i>
Copy Machine Equivalency List	i
Descriptions of Katun Product Brands and Technologies	iii
Beschreibungen der Produktmarken und Technologien von Katun	vii
Personalized Product Agreement	xi
Vereinbarung Über Bestellung Von Produkten Mit Ihrem Firmenetikett	xiii
Bearings/Bushings	1
Belts	4
Blades/Brushes	5
Corona/Charge/Transfer	6
Developers	9
Electrical	10
Feed/Delivery	11
Filters	14
Fuser Cleaning	15
Kits	16
Lamps	17
Memory Upgrades	18
Photoreceptors	19
Picker Fingers	21
Rollers, Fuser/Heat	22
Rollers, Pressure	23
Thermal Control Devices	24
Toners/Toner Cartridges	25
Waste Toner Containers	28
General Information	I
Allgemeine Hinweise	III
Distributor Choice Warranty Claim Form	V
HÄNDLER-GARANTIEFORMULAR	VII



Copy Machine Equivalency List

Central/Eastern Europe
 Telephone: 31(0)183-696969
 Fax: 31(0)183-629055
 E-mail: order@edc.katun.com

Panasonic	Develop	Minolta	Olympia	Roneo-Alcatel
FP 820			OMEGA 5008	308
FP 1000			OMEGA 3010	
FP 1100			OMEGA 3011	214 RE
FP 1270	1211	EP 2120		
FP 1275	1212	EP 2121		
FP 1300			OMEGA 3013	213
FP 1307			OMEGA 3013 E	313
FP 1370	1311	EP 2130		
FP 1510			OMEGA 3015 E	315 RE
FP 1520			OMEGA 3015	215 RE
FP 1530			OMEGA 3015 Z	315 ZC
FP 1540			OMEGA 3015 D	415 ZD
FP 1570			OMEGA 5015 Z	515 ZC
FP 1800			OMEGA 2020	
FP 1802			OMEGA 2002 U	218
FP 2230			OMEGA 5022	322 ZC
FP 2520			OMEGA 3025	225 RE
FP 2625			OMEGA 3026	226 RE
FP 3000			OMEGA 2030 S	
FP 3001			OMEGA 2030 M	230
FP 3007			OMEGA 3030 E	330
FP 3010 R			OMEGA 2050 M	230 R
FP 3030			OMEGA 3030	330 Z
FP 3037			OMEGA 5030	
FP 3040			OMEGA 3040	430 Z
FP 4520			OMEGA 3045	245 RE
FP 4630			OMEGA 5046 Z	446 Z
FP 4650			OMEGA 3046	446 ZD
FP 5060			OMEGA 5050 ZD	550 ZD
FP 6070	6060	EP 8600		
FP 7160	D 6050	EP 6000		
FP 7181	D 8150	EP 8010		
FP 7760	D 6051	EP 6001		
FP 7781	D 8151	EP 8015		
FP D620	D 6200 iD	Di 620		
A- 620	EDH- 1	EDH- 1		
A- 780	AFR- 2	AFR- 2		
A- 901	AFR- 10	AFR- 10		
A- 910	AFR- 9	AFR- 9		
A- 920	AFR- 13	AFR- 13		
A- 990	AFR- 1000	AFR- 1000		
AFR- 4	AFR- 4	AFR- 4		
F 620		FN- 102		
F 630		FN- 502		
F 640	FN- 3	FN- 3		
F- 500	FN- 1	FN- 1		
F- 800		RDH- 1		
L 3010	C- 304	C- 304		
L 3020	C- 304 L	C- 304 L		
L- 2060	C- 202	C- 202		
L- 3000	C- 302	C- 302		
L- 3005	C- 303	C- 303		
L- 4001	C- 402	C- 402		

Central/Eastern Europe
Telephone: 31(0)183-696969
Fax: 31(0)183-629055
E-mail: order@edc.katun.com

Copy Machine Equivalency List

Panasonic	Develop	Minolta	Olympia	Roneo-Alcatel
S- 420	S- 202	S- 202		
S- 430	S- 20 VI	S- 20 VI		
S- 490	ST- 201	ST- 201		
S- 700	S- 206	S- 206		
S- 710	ST- 207	ST- 207		
S- 720	S- 209	S- 209		
S- 740	ST- 212	ST- 212		
S- 750	ST- 213	ST- 213		
S- 755	ST- 1100	ST- 1100		
S- 810	ST- 208	ST- 208		
SP- 810	HP- 1	HP- 1		
T- 303	T- 303	T- 303		
T- 312	T- 312	T- 312		
UF- 60	T- 302	T- 302		

Descriptions of Katun Product Brands and Technologies

Katun Performance Products

Katun Performance is our complete line of office automation products that combine our highest quality level with consistent, reliable performance and competitive pricing - and provide excellent overall value.

Katun Performance products meet strict quality guidelines and have been 100% tested and approved according to the Katun 360° Certification process, which includes environmental testing, forward and reverse compatibility testing, model application testing, and component compatibility testing. In addition, all Katun Performance products are warranted to be free from functional defects in material and workmanship for one year and come with the highest level of Katun technical support.

To locate Katun Performance products, look for the Katun Performance icon  throughout this catalog.

Access by Katun Products

Access by Katun is a line of selected products that address the unique pricing or product needs of specific markets. Access by Katun products provide market acceptable quality and market competitive pricing. The Access by Katun product line complements the Katun Performance line by providing a value proposition based primarily on specific market needs.

Access by Katun products come with a limited level of product support and a one-year warranty. Although Access by Katun products provide some price advantages, remember that Katun Performance products always provide excellent overall value.

Original Products

Select OEM brand products that Katun offers to meet certain market needs

Fuser Roller Coating Technologies

Minco Manufacturing, Inc., a wholly owned subsidiary of Katun Corporation, is a world-leading manufacturer of fuser rollers for use in plain paper copiers, facsimiles, and printers. The product development relationship between Katun, Minco, and DuPont, the exclusive manufacturer of genuine TEFLON[®] brand coatings, has produced numerous advanced fuser roller coating technologies, including:

DURAPREM[™] II upper fuser rollers are manufactured with a heat-resistant, nonstick TEFLON[®] brand coating that provides increased surface hardness for extended potential life. A proprietary finishing process produces an exceptionally smooth surface, which contributes to these rollers' excellent fusing performance and toner release in machines using negative-charge toner.

DURACON[™] II upper fuser rollers are manufactured with a heat-resistant, nonstick TEFLON[®] brand coating that includes patented conductive additives for static dissipation. These rollers provide excellent fusing performance, toner release, and long life, primarily in machines using positive-charge toner.

ALUMANA[™] upper fuser rollers are manufactured with extremely hard, tough primer and midcoat layers for maximum resistance to wear and abrasion. The ceramic ALUMANA coating combines a DuPont-patented polymer blend with reinforcing oxides for enhanced durability. These heavy-duty rollers are specifically designed to meet the demands of hostile fuser station environments and higher-speed machines using either positive-charge or negative-charge toner.

TRITON[™] II upper fuser rollers are manufactured with an advanced TEFLON[®] brand coating that provides improved fusing performance and nonstick characteristics in comparison to conventional fluoropolymer coatings. Unique static-dissipative particulates within the TRITON II coating, together with enhanced manufacturing processes, contribute to these rollers' superior abrasion- resistance and excellent toner release. These rollers provide extended potential life in selected machines using either positive- charge or negative-charge toner.

Central/Eastern Europe

Telephone: 31(0)183-696969

Fax: 31(0)183-629055

E-mail: order@edc.katun.com

TRITON BLUE™ upper fuser rollers deliver excellent performance for machine applications that are tough on fuser rollers. Manufactured with an advanced TEFLON® brand coating that provides improved fusing performance and nonstick characteristics in comparison to conventional fluoropolymer coatings, TRITON BLUE™ fuser rollers combine improved wear resistance with superior abrasion-resistance and excellent toner release.

REVOLUTION™ upper fuser rollers utilize a PFA sleeve coating that is more environmentally friendly than standard spray technology, while still achieving uniform coating thickness and even heat distribution. These fuser rollers provide proper fusing, excellent abrasion resistance and long life, even during extensive copy runs.

TUF/SIL™ upper fuser rollers are manufactured with a layer of silicone rubber that effectively regulates heat flow to the toner, plus an outermost layer that consists of a specially blended TEFLON® brand coating providing excellent toner release and abrasion-resistance. This combination ensures reduced toner offsetting and improved, more consistent copy quality under certain demanding machine usage conditions. These rollers provide a high-performance, cost-effective solution for selected machines required to consistently produce the best possible copy quality.

MICROSLEEVE™ lower pressure rollers, with nonstick PFA sleeves 50, 70, or 100 microns in thickness, provide excellent wear-resistance for improved copy quality over an extended life. A-Series MICROSLEEVE™ lower pressure rollers are designed specifically for machines utilizing lower fuser cleaning rollers. Their unique surface texture reduces toner buildup and improves cleaning efficiency within the fuser station.

All Katun fuser rollers are designed specifically for their intended applications and manufactured to exacting quality standards, ensuring their excellent performance and long life.

Fuser Cleaning Roller Coating Technologies

Katun has introduced unique fuser cleaning roller technologies for machines requiring efficient removal and absorption of excess toner and contaminants, as well as continuous silicone oil lubrication of critical fuser station parts. For many machines, the ideal parts combination for achieving optimum copy quality and maximum parts life includes a specially designed Katun fuser cleaning roller.

FIBRA™ fuser cleaning rollers incorporate a uniform network of special fibers that aggressively remove excess toner and contaminants from the contacted surface. By efficiently depositing toner and contaminants beneath its outermost surface, the unique FIBRA network also helps maintain a continuous lubricative flow of silicone oil from the roller's internal tank to critical fuser station parts.

FIBRA™ II fuser cleaning rollers incorporate a unique configuration of highly heat-resistant fibers to greatly enhance cleaning performance, especially in hostile fuser station environments. Efficient absorption of excess toner and contaminants, together with continuous silicone oil lubrication of critical fuser station parts, effectively reduce parts and service expenses associated with the fuser station.

TEFLON® is a registered trademark of E.I. DuPont de Nemours and Company used under license by Katun Corporation.

Personalized Product Program

Katun offers an extremely cost-effective way for office equipment dealers/distributors to ensure repeat business and strengthen relations with customers. The **Personalized Product program** enables dealers/distributors to provide high-quality Katun Performance imaging supplies (toner, fax and printer toner cartridges, digital duplicator inks and masters and thermal transfer ribbons) with their business name and /or logo, plus contact information, so end-users always know whom to call to reorder. For a one-time, nominal set-up fee, Katun designs and produces full-color labels to customer specifications and applies them to packaging at no extra charge. Only end-user-replaceable Katun Performance products are eligible under the program. Enrollment is simple and easy. Just complete the agreement form and submit it to your Katun sales representative or visit the [Personalized Products](#) page for more program and enrollment information.



Beschreibungen der Produktmarken und Technologien von Katun

Katun Performance-Produkte

Katun Performance ist unsere umfangreiche Produktreihe von Büromaschinenprodukten, die sich durch hohe Qualität sowie durch beständige, zuverlässige Leistung und attraktive Preise auszeichnen. Mit diesen Produkten soll der Nutzwert für den Kunden maximiert werden.

Katun Performance -Produkte erfüllen strenge Qualitätsstandards und wurden alle im Rahmen des 360° -Zertifizierungsverfahrens von Katun getestet und freigegeben. Die Produkte durchlaufen dabei Prüfungen der Umweltverträglichkeit, der Kompatibilität, der Modellanwendungen und der Komponentenkompatibilität. Darüber hinaus wird bei allen Katun Performance-Produkten ein Jahr lang gewährleistet, dass diese frei von funktionalen Material- und Verarbeitungsfehlern sind. Selbstverständlich steht Ihnen auch der hochwertige technische Support von Katun zur Verfügung.

Um die Katun Performance-Produkte zu finden, halten Sie in diesem Katalog nach dem Namen Performance  und dem entsprechenden Symbol Ausschau.

Originalprodukte

Sie können verschiedene OEM-Produkte auswählen, die Katun aufgrund der Nachfrage auf dem Markt in sein Produktangebot aufgenommen hat.

Beschichtungstechnologien für Heizwalzen

Minco Manufacturing Incorporated, eine hundertprozentige Tochtergesellschaft der Katun Corporation, ist einer der weltweit führenden Hersteller von Heizwalzen für Kopierer, Faxgeräte und Drucker. Die enge Zusammenarbeit zwischen Katun, Minco und DuPont, dem alleinigen Hersteller originaler TEFLON[®] - Beschichtungen, hat zur Entwicklung von zahlreichen neuartigen Beschichtungsmaterialien für Heizwalzen geführt:

DURAPREM[™] II Heizwalzen sind mit einer temperaturbeständigen TEFLON[®] - Antihaf-Beschichtung ausgestattet und besitzen daher eine größere Oberflächenhärte für eine potenziell längere Lebensdauer. Die nach einem speziellen Finish-Verfahren hergestellte, außerordentlich glatte Walzenoberfläche bietet hervorragende Fixier- und Antihaf-Eigenschaften in Geräten mit negativ geladenem Toner.

DURACON[™] II Heizwalzen sind mit einer temperaturbeständigen TEFLON[®] - Antihaf-Beschichtung ausgestattet, der patentierte, elektrisch leitfähige Inhaltsstoffe beigemischt sind, um das Ableiten von sich bildender statischer Ladung zu ermöglichen. Diese Heizwalzen zeichnen sich durch ihre hervorragenden Fixier- und Antihaf-Eigenschaften sowie eine lange Nutzungsdauer aus, besonders in Geräten mit positiv geladenem Toner.

ALUMANA[™] Heizwalzen besitzen eine äußerst harte, widerstandsfähige Grund- und Zwischenschicht für eine höchstmögliche Verschleißfestigkeit und Haltbarkeit. Die ALUMANA Keramiksicht beinhaltet eine patentierte Polymer-Mischung von DuPont mit Verstärkungsoxiden für eine erhöhte Widerstandsfähigkeit.

Diese robusten Heizwalzen sind speziell für anspruchsvolle Betriebsbedingungen in der Fixierstation und für schnellere Kopierer mit positiv oder negativ geladenem Toner konstruiert.

TRITON[™] II Heizwalzen zeichnen sich durch ihre hochwertige TEFLON[®] -Beschichtung aus, die herkömmlichen Fluorpolymer-Beschichtungen in Bezug auf Fixier- und Antihaf-Eigenschaften überlegen ist. Spezielle antistatisch wirkende Partikel in der TRITON II-Beschichtung und hohe Fertigungsstandards tragen zu den ausgezeichneten Antihaf-Eigenschaften und der hervorragenden Verschleißfestigkeit dieser Heizwalzen bei.

Sie bieten potentiell längere Laufzeiten in ausgewählten Geräten sowohl mit positiv als auch mit negativ geladenem Toner.

Central/Eastern Europe

Telephone: 31(0)183-696969

Fax: 31(0)183-629055

E-mail: order@edc.katun.com

Die TRITON BLUE™ Oberen Heizwalzen bieten eine hervorragende Leistung in Maschinenanwendungen, bei denen die Heizwalzen stark beansprucht werden. Die TRITON BLUE™ Heizwalzen werden mit einer fortschrittlichen TEFLON®-Beschichtung hergestellt, die eine höhere Heizleistung und bessere Antihaft-Eigenschaften im Vergleich zu herkömmlichen Fluorpolymerbeschichtungen bietet. Darüber hinaus zeichnen sich diese Heizwalzen durch eine hohe Verschleißfestigkeit aus.

REVOLUTION™ Obere Heizwalzen zeichnen sich durch eine PFA-Beschichtung aus, die umweltfreundlicher ist als die traditionelle Sprühtechnologie. Gleichzeitig werden eine einheitliche Beschichtungsdicke und eine gleichmäßige Hitzeverteilung sichergestellt. Zu den Vorteilen dieser Heizwalzen gehören eine optimale Fixierung, eine hervorragende Verschleißfestigkeit und eine lange Lebensdauer auch bei umfangreichen Druckläufen.

TUF/SIL™ Heizwalzen besitzen eine Silikonbeschichtung, die für eine effiziente regulierte Wärmeableitung an den Toner sorgt, sowie eine besonders zusammengesetzte TEFLON®-Beschichtung mit ausgezeichneten Antihaft-Eigenschaften und hoher Verschleißfestigkeit. Dies führt zu weniger Toner-Offsetting-Problemen und gewährleistet auch unter anspruchsvollen Betriebsbedingungen eine gleichbleibend hohe Kopienqualität. Die TEFLON®/SILIKON Heizwalzen bieten ein sehr gutes Preis-/Leistungsverhältnis für ausgewählte Geräte, die höchste Qualitätsansprüche in Bezug auf die Kopienqualität stellen.

MICROSLEEVE™ Presswalzen mit Antihaft-PFA-Ummantelung in den Stärken 50, 70 und 100 µm bieten eine außergewöhnliche Haltbarkeit und damit eine langfristig bessere Kopienqualität und längere Nutzungsdauer. Die Presswalzen der MICROSLEEVE™ A-Serie sind speziell für den Einsatz in Geräten gedacht, bei denen eine Reinigung der unteren Presswalze mittels Reinigungswalze stattfindet.

Ihre besondere Oberflächenstruktur reduziert Tonerablagerungen und verbessert die Reinigungswirkung in der Fixierstation.

Alle Heizwalzen von Katun wurden speziell im Hinblick auf deren Einsatzzweck entwickelt und erfüllen höchste Qualitätsstandards. Nicht umsonst zeichnen sie sich durch eine herausragende Leistung und eine lange Nutzungsdauer aus.

Beschichtungstechnologien für Reinigungswalzen

Katun hat spezielle Reinigungswalzen für Geräte entwickelt, die eine wirksame Beseitigung von Tonerresten und Schmutz sowie eine kontinuierliche Versorgung wichtiger Teile der Fixierstation mit Silikonöl erfordern. Durch den Einsatz einer Katun Reinigungswalze kann bei vielen Geräten eine optimale Kopienqualität und eine größtmögliche Nutzungsdauer der Komponenten erzielt werden.

FIBRA™ Reinigungswalzen entfernen Tonerreste und Schmutzpartikel durch ein spezielles Fasernetz effizient von der Walzenoberfläche. Während das FIBRA-Fasernetz die Verschmutzungen wirkungsvoll in seiner Oberfläche aufnimmt, sorgt es zugleich für eine Dauerversorgung wichtiger Teile der Fixierstation mit Silikonöl aus dem Vorratstank im Walzeninneren.

FIBRA™II Reinigungswalzen besitzen ein neuartiges, hitzebeständiges Fasernetz, mit denen besonders unter anspruchsvollen Betriebsbedingungen eine erheblich verbesserte Reinigungswirkung erzielt wird.

Durch die wirksame Aufnahme von Tonerresten und Schmutzstoffen bei gleichzeitiger Dauerversorgung wichtiger Teile in der Fixierstation mit Silikonöl können die Austausch- und Servicekosten für die Fixierstation erheblich gesenkt werden.

TEFLON® ist ein eingetragenes Warenzeichen von E.I. DuPont de Nemours and Company und wird von der Katun Corporation unter Lizenz verwendet.

Firmenetiketten-Programm

Katun bietet Händlern einen äußerst kostengünstigen Weg, ihre Kunden an sich zu binden und Kundenbeziehungen zu verbessern. Das **Firmenetiketten-Programm** erlaubt es Händlern, qualitativ hochwertige Verbrauchsmaterialien von Katun Performance (Toner, Drucker-/Faxkartuschen, Tinten für Digitalkopierer und Thermotransferrollen) mit ihrem Firmennamen und/oder Logo sowie mit Kontaktinformationen zu versehen. So wissen Verbraucher immer, bei wem sie Produkte nachbestellen können. Für eine einmalige, geringe Bearbeitungsgebühr entwirft und produziert Katun Performance vollfarbige Etiketten nach Ihren eigenen Angaben. Diese werden kostenfrei auf die entsprechenden Verpackungen aufgebracht. Unter dieses Programm fallen nur Produkte, die vom Endverbraucher nachbestellt werden können. Die Teilnahme an dem Programm ist ganz einfach. Füllen Sie einfach die Vereinbarung aus und senden Sie diese an Ihren Katun- Ansprechpartner oder besuchen Sie uns auf unserer Homepage-unter Firmenetiketten-Programm für weitere Information zu diesem Programm und den Teilnahmebedingungen.

Personalized Product Agreement

Customer Information

Customer Number: _____ Phone Number: _____
 Contact Name: _____ Fax Number: _____
 Title: _____ Katun Representative: _____

Customer agrees to:

- Provide pertinent information, a scanable copy of your company logo, or other desired label artwork, and color specifications for the labels.
- Pay a one-time, nominal setup fee upon approval of the label design. (Ask your sales representative for details.)
- Order in full master carton quantities.

Katun agrees to:

- Create a personalized, full-color label design to your specifications, per the information provided on page two of this form, for a one-time, nominal setup fee and send a proof for approval within a minimum of 7 days of receipt of this agreement.
- Produce labels printed with the customer's approved design on white label stock, and affix them over the Katun Performance logo* on copier toner, printer/fax toner cartridge, digital duplicator ink/master packaging.
- Ship initial order within one week after the customer approves their Personalized Product label proof. Reorders will also ship within one week.

Projected Personalized Product Purchases

Katun Part Number**	OEM Line	Product/Model Description	Minimum Order Quantity	Projected Monthly Order***
P			One master carton	
P			One master carton	
P			One master carton	
P			One master carton	
P			One master carton	
P			One master carton	

Signature: _____ Date: _____

*Only Katun Performance products can be personalized.

**The Personalized Product part number is the regular Katun Performance part number with a 'P' added at the end. See the Katun catalog for master carton quantities.

*****Projection only.** You are not committed to ordering the quantity you list on this form.

NOTE: Products with personalized labels cannot be returned to Katun for credit unless a valid warranty claim exists.

Please Also Complete Page 2

Central/Eastern Europe

Telephone: 31(0)183-696969

Fax: 31(0)183-629055

E-mail: order@edc.katun.com

Information for Personalized Product Label

Please list *only* the information you want to appear on your Personalized Product label.

Company Name: _____

Street Address: _____

City: _____

State/Province: _____ **Postal Code:** _____

Phone Number: _____ **Fax Number:** _____

Other: _____

Label Artwork

- **Attach a copy of your company logo and/or any other requested graphic elements.** Artwork may be full color or black and white. We prefer original-quality artwork 4" x 4" (100mm x 100mm) or larger, but will accept a business card or sheet of company letterhead.
- **Please indicate your color preferences.** In the space below, please indicate the color(s) you want to use for all text, your company logo, and any other graphic elements. If appropriate, please supply accurate samples to be matched or specify Pantone or PMS color numbers. **NOTE:** Your labels will be printed on a thermal-transfer printer at a resolution of 300 dpi. Therefore color photographs cannot be printed and some colors may be difficult to match precisely.

Label Sizes

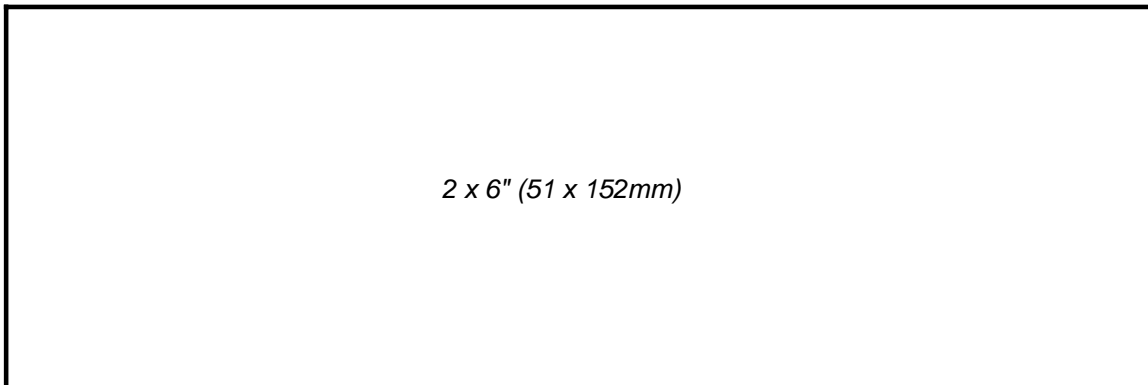
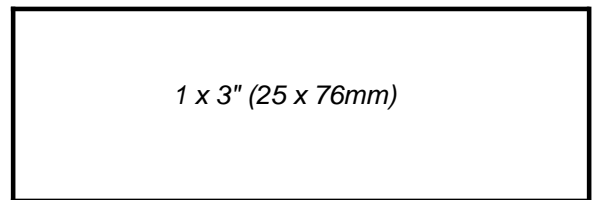
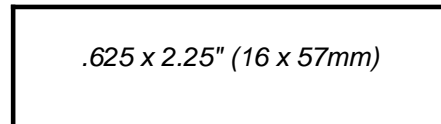
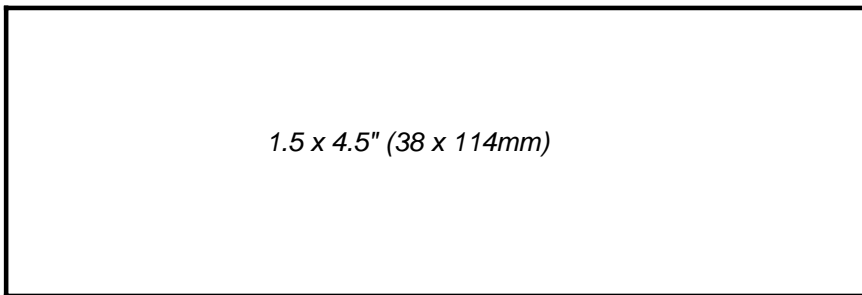

Vereinbarung über Bestellung von Produkten mit Ihrem Firmenetikett

Kundeninformationen

Kundennummer: _____ Telefon: _____
 Ansprechpartner: _____ Fax: _____
 Position: _____ Ihr Katun-Repräsentant: _____

Der Kunde ist einverstanden:

- Katun die benötigten Informationen vorzulegen (ein zum Scannen geeignetes Muster Ihres Firmenlogos bzw. Muster anderer gewünschter Grafikelemente sowie Farbspezifikationen für die Etiketten);
- nach Genehmigung des Etiketten-Layouts eine einmalige, geringe Bearbeitungsgebühr zu entrichten. Weitere Informationen erhalten Sie von Ihrem Katun-Repräsentanten;
- Toner in den jeweiligen Verpackungseinheiten/Umkartons zu bestellen.

Katun verpflichtet sich:

- ein Vollfarbetikett nach den Kundenangaben zu entwerfen (siehe Seite 2 dieses Formulars). Hierfür wird eine einmalige, geringe Bearbeitungsgebühr erhoben. Nach Eingang dieser Vereinbarung bei Katun erhält der Kunde innerhalb von ca. sieben Werktagen einen Korrekturabzug.
- Etiketten in Standardgröße mit dem vom Kunden genehmigten Layout auf weißem Etikettenpapier zu drucken und über dem Katun Performance-Logo* auf der Verpackung von Toner für Kopierer, Tonerkartuschen für Drucker/Faxgeräte, Tinte bzw. deren Umkartons für digitale Duplikatoren anzubringen.
- den Toner-Erstauftrag innerhalb von einer Woche nach Genehmigung des firmeneigenen Etiketts zu versenden. Nachbestellungen werden ebenfalls innerhalb einer Woche erledigt.

Erwartete Abnahmemenge von Produkten mit Ihrem Firmenetikett

Katun Artikelnummer**	Maschinenlinie	Produkt-/Modellbeschreibung	Mindestmenge	Erwartete monatliche Bestellung***
P			Ein Umkarton	
P			Ein Umkarton	
P			Ein Umkarton	
P			Ein Umkarton	
P			Ein Umkarton	
P			Ein Umkarton	

Unterschrift: _____ Datum: _____

*Nur Katun Performance Produkte können mit Firmenetiketten bestellt werden.

**Die Artikelnummer für Produkte mit Ihrem Firmenetikett ist die normale Katun Performance Artikelnummer, der ein "P" am Ende nachgestellt ist. Sehen Sie die Umkartonmengen im Katun-Katalog nach.

***Nur Schätzungen. Sie sind nicht verpflichtet, die hier angegebene Menge abzunehmen.

HINWEIS: Produkte mit Firmenetiketten können nur bei einer berechtigten Reklamation gutgeschrieben werden.

Füllen Sie bitte auch Seite 2 aus.

Bestellinformationen für firmeneigenes Etikett

Geben Sie bitte *nur* die Informationen an, die auf dem Etikett erscheinen sollen.

Name der Firma: _____

Strasse: _____

PLZ/Ort: _____

Telefon: _____ Fax: _____

Sonstiges: _____

Layout des Etiketts

- **Bitte legen Sie kein Muster Ihres Firmenlogos sowie ggf. Muster anderer gewünschter Grafikelemente bei.** Geeignet sind Grafiken in Farbe oder Schwarzweiß, vorzugsweise Originale mit einer Mindestgröße von 100 x 100 mm. Wir können auch Ihre Visitenkarte oder Ihren Briefkopf verarbeiten.
- **Bitte geben Sie die gewünschten Farben an.** Tragen Sie unten bitte die Farbe(n) für alle Textelemente, Ihr Firmenlogo sowie andere grafische Elemente ein. Legen Sie ggf. ein Farbmuster bei, oder geben Sie die Pantone- bzw. PMS-Farbnummern an.
HINWEIS: Ihre Firmenetiketten werden auf einem Thermodrucker mit einer Auflösung von 300 DPI erstellt. Es können daher keine Farbfotos gedruckt werden, und bestimmte Farben können u. U. nicht exakt wiedergegeben werden.





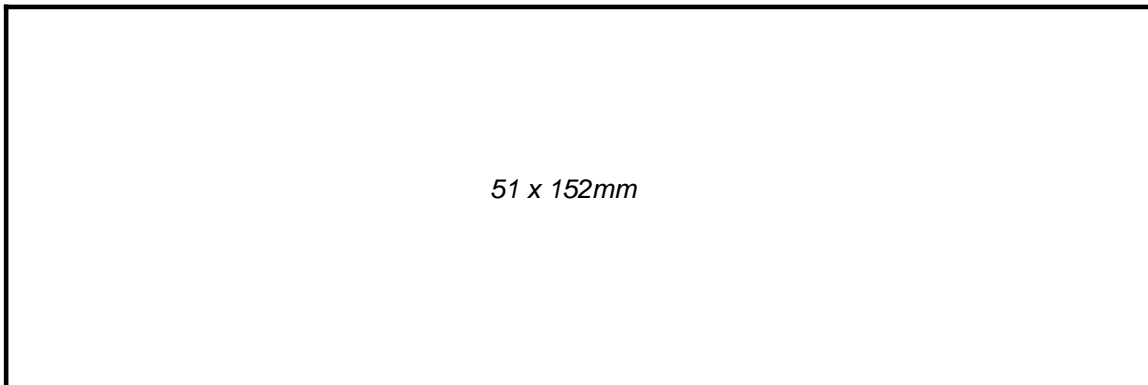
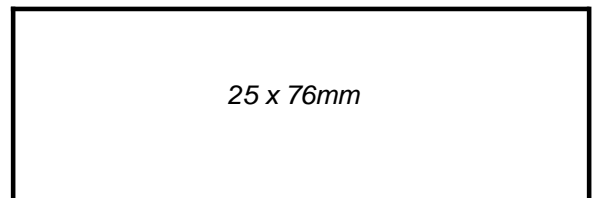
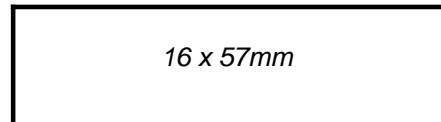
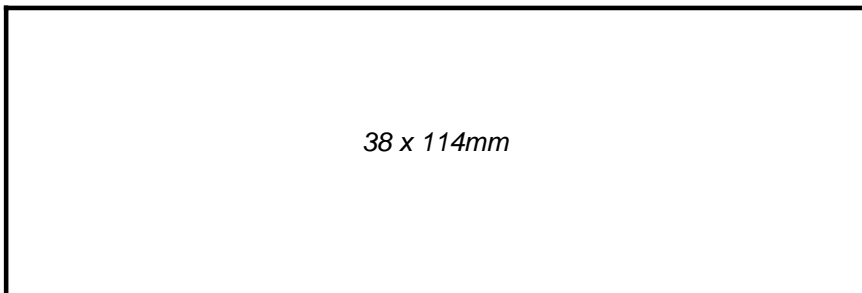











Etikettengrößen



For use in
Panasonic
 Copiers

Central/Eastern Europe
 Telephone: 31(0)183-696969
 Fax: 31(0)183-629055
 E-mail: order@edc.katun.com

OEM PN	KATUN PN	DESCRIPTION	MODEL NO.
Bearings/Bushings			
DZLM000112	32576204 	Lower Fuser Roller Bearing	DP 2000, DP 2000 P, DP 2310, DP 2500, DP 2500 D, DP 2500 P, DP 3000, DP 3000 E, DP 3010
DZLM000117	32576233 	Bearing	DP 2000, DP 2000 P, DP 2500, DP 2500 D, DP 2500 P, DP 3000, DP 3000 E
DZLM000188	32021630 	Upper Fuser Roller Bearing	DP 2000, DP 2500, DP 2500 D, DP 3000, DP 3000 E
DZLM000168	32576217 	Upper Fuser Roller Bearing	DP 2310, DP 3010, DP 3510, DP 3520, DP 4510, DP 4520 G, DP 4520 H, DP 6010, DP 6020 G, DP 6020 H
FFPMQ0211	32576233 	Bearing Various Applications	DP 3510, DP 4510, DP 6010, FP 4650, FP 5060, FP 7718, FP 7722, FP 7728, FP 7735, FP 7735 MX, FP 7742, FP 7750, FP 7818, FP 7824, FP 7830, FP 7835, FP 7845, FP 7850, FP D250, FP D250 F, FP D350, FP D350 F, FP D350 H, FP D355, FP D355 DC, FP D450, FP D455, FP D600, FP D605, DS- 22, DS- 22 B
		Lower Fuser Roller	FP 1307, FP 1510, FP 1530, FP 1540, FP 1570
FFPMQ0303	32576233 	Bearing	FP C1 XE
FFPMQ0305	32576131 	Bearing	FP C1 XE
FFPMQ0117	32576205 	Bearing Various Applications	FP C1 XE, FP 1300, FP 1520
FFPMQ0177	32576118 	Bearing	FP C1 XE, FP 1520, DS- 725
FFPMQ0043	32576107 	Lower Fuser Roller Bearing	FP C1 XE, FP 1670, FP 1670 A, FP 1680, FP 1780, FP 1802, FP 2080, FP 2230, FP 2520, FP 2625, FP 2670, FP 2680, FP 3002, FP 3007, FP 3010 R, FP 3030, FP 3037, FP 3040, FP 3270, FP 3380, FP 4080, FP 4520, FP 7117, FP 7121, FP 7127, FP 7133, FP 7140
FFPMQ0043K	32576107 	Lower Fuser Roller Bearing	FP C1 XE, FP 1670, FP 1670 A, FP 1680, FP 1780, FP 1802, FP 2080, FP 2230, FP 2520, FP 2625, FP 2670, FP 2680, FP 3002, FP 3007, FP 3010 R, FP 3030, FP 3037, FP 3040, FP 3270, FP 3380, FP 4080, FP 4520, FP 7117, FP 7121, FP 7127, FP 7133, FP 7140
FFPMQ0245	32576224 	Upper Fuser Roller Bearing For use with Heat Insulating Sleeve OEM Part No. FFPJF0014.	FP C1 XE, FP 3007, FP 3030, FP 3037, FP 3040
FFPM45528101	32016005 	Upper Fuser Roller Bearing	FP 1100
1067-5705-01	32015954 	Lower Fuser Roller Bearing	FP 1270, FP 1275, FP 1370





















Katun Performance Product

© 2004 Katun Corporation

26 October 2004

For the most current product and pricing information, visit the Katun On-Line Catalog at www.katun.com.

Prices, terms and conditions are subject to change without notice.

OEM PN	KATUN PN	DESCRIPTION	MODEL NO.
Bearings/Bushings			
FFPMQ0120	32576131 	Upper Fuser Roller Bearing	FP 1300, FP 1520
FFPMQ00352	32576107 	Bearing	FP 1520, FP 2520, FP 2625
FFPXT009300	32576107 	Lower Fuser Roller Bearing	FP 1800, FP 1801, FP 1802, FP 3000, FP 3001, FP 3002
FFPMQ0246	32576203 	Lower Fuser Roller Bearing	FP 4630, FP 4650, FP 5060
1300-4342-04	32576118 	Bearing Various Applications	FP 6070
1300-4344-03	32576205 	Bearing Various Applications	FP 6070
1300-4342-03	32576118 	Bearing Various Applications	FP 6070, FP 7160, FP 7181, FP 7760, FP 7781, FP D620
1300-4394-26	32576131 	Fuser Roller Bearing Lower	FP 6070, FP 7160, FP 7760, FP 7781, FP D620
1300-4394-28	32576225 	Upper Fuser Roller Bearing	FP 6070, FP 7181
FFPMQ0520	32576118 	Lower Fuser Roller Bearing	FP 7113, FP 7115, FP 7713, FP 7715
1300-4342-07	32576233 	Bearing Various Applications	FP 7160, FP 7181, FP 7760, FP 7781, A- 620, A- 910, A- 920, A- 990, S- 420, S- 430
1075-5771-01	32576216 	Upper Fuser Roller Bearing	FP 7160, FP 7760, FP 7781, FP D620
1075-5772-01	32021818 	Heat Insulating Sleeve	FP 7160, FP 7760, FP 7781, FP D620
1273-3516-01	32576118 	Bearing	FP 7160, FP 7760, FP 7781, FP D620, A- 910, A- 920, A- 990
1145-5804-01	32576203 	Lower Fuser Roller Bearing	FP 7181
FFPMQ0583	32016005 	Upper Fuser Roller Bearing	FP 7718, FP 7722, FP 7818, FP 7824
FFPMQ0584	32576209 	Upper Fuser Roller Bearing	FP 7728, FP 7735, FP 7735 MX, FP 7830, FP 7835, FP D250, FP D250 F, FP D350, FP D350 F, FP D350 H, FP D355, FP D355 DC
FFPMQ0572	32576216 	Upper Fuser Roller Bearing	FP 7742, FP 7750, FP 7845, FP 7850, FP D450, FP D455, FP D600, FP D605
688ZZNRM3	32576233 	Bearing	A- 300



*Priced per Bushing,
 sold in Bags of 2.*





For use in
Panasonic
Copiers

Central/Eastern Europe
Telephone: 31(0)183-696969
Fax: 31(0)183-629055
E-mail: order@edc.katun.com

OEM PN	KATUN PN	DESCRIPTION	MODEL NO.
-----------	-------------	-------------	--------------

Bearings/Bushings

1203-5009-01	32576233 	Bearing Various Applications	A- 780
XLC608ZZ-0	32576205 	Bearing	S- 300, S- 301

OEM PN	KATUN PN	DESCRIPTION	MODEL NO.
Belts			
1284-3511-01	32011916 	Original Document Feed Belt	A- 780, AFR- 4
FFPML0022	32014644 	Original Document Feed Belt	A- 880
PF2214P353A	32019289 	Document Feed Belt	A- 888
4426-5501-02	32014361 	Original Document Feed Belt	A- 901, A- 910, A- 920, A- 990
1279-3507-01	32011916 	Original Document Feed Belt	AFR- 4

For use in
Panasonic
 Copiers







Central/Eastern Europe
 Telephone: 31(0)183-696969
 Fax: 31(0)183-629055
 E-mail: order@edc.katun.com

OEM PN	KATUN PN	DESCRIPTION	MODEL NO.
Blades/Brushes			
FFPM43228102	32244598	Drum Cleaning Blade	FP 1100
FFPM43228102	32022575	Drum Cleaning Blade Access By Katun	FP 1100
FFPM43228105 <i>Final Inventory</i>	32243450	Drum Cleaning Blade Seal	FP 1100
1067-5501-01	32009601	Drum Cleaning Blade For Use in Old Style Imaging Units	FP 1270, FP 1275
1132-5543-01	32010398	Drum Cleaning Blade For Use in New Style Imaging Units	FP 1270, FP 1275, FP 1370
FFPHK06331	32010548	Drum Cleaning Blade	FP 1670, FP 1680, FP 1780, FP 2080, FP 2670, FP 2680, FP 3270, FP 3380, FP 4080, FP 7117, FP 7121, FP 7127, FP 7133, FP 7140
1031-0156-03	32243427	Drum Cleaning Blade	FP 6070
FFPHK0905	32016895	Drum Cleaning Blade Access By Katun	FP 7113, FP 7115
FFPHK0905	32022577	Drum Cleaning Blade Access By Katun	FP 7113, FP 7115
1074-0156-01	32014741	Toner Anti-Spill Blade	FP 7160, FP 7181, FP 7760, FP 7781, FP D620
1075-0902-01	32014426	Drum Cleaning Blade Kit Blade only	FP 7160, FP 7760, FP 7781
1074-0155-02	32010547	Drum Cleaning Blade	FP 7181
1074-0904-01	32010547	Drum Cleaning Blade Kit	FP 7181, FP D620
FFPHK09051	32016895	Drum Cleaning Blade Access By Katun	FP 7713, FP 7715
FFPXG65H00	32016896	Drum Cleaning Blade	FP 7718, FP 7722, FP 7728, FP 7735, FP 7735 MX, FP 7742, FP 7750
FFPKD13401	32022799	Toner Seal Blade	FP 7718, FP 7722, FP 7728, FP 7735, FP 7742, FP 7750, FP D250, FP D350, FP D350 H, FP D355, FP D355 DC, FP D450, FP D455, FP D600, FP D605
FFPKD13402	32022800	Toner Seal Blade	FP 7818, FP 7824, FP 7830, FP 7835, FP 7845, FP 7850
FFPXG65L001	32019182	Drum Cleaning Blade	FP 7818, FP 7824, FP 7830, FP 7835, FP 7845, FP 7850
FFPXG65L00	32019182	Drum Cleaning Blade Assembly	FP D250, FP D250 F, FP D350, FP D350 F, FP D350 H, FP D355, FP D355 DC, FP D450, FP D455, FP D600, FP D605











Katun Performance Product

© 2004 Katun Corporation

OEM PN	KATUN PN	DESCRIPTION	MODEL NO.	
Corona/Charge/Transfer				
FFPEY0074	32023075 	Corona Wire 60μ 0.3μ Gold Plated	DP 130 P, DP 135, DP 135 FP, DP 135 P, DP 150, DP 150 A, DP 150 FP, DP 150 P	<i>Priced per Corona Wire, sold in Packages of 10.</i>
FFPXL05H00	32014601 	Corona Wire 60μ 0.3μ Gold Plated Various Applications Separation Charge, Separation	DP 3520, DP 4520 G, DP 4520 H, DP 6020 G, DP 6020 H DP 3510, DP 4510, DP 6010 FP 7718, FP 7722, FP 7728, FP 7735, FP 7735 MX, FP 7742, FP 7750, FP 7818, FP 7824, FP 7830, FP 7835, FP 7845, FP 7850, FP D250, FP D250 F, FP D350, FP D350 F, FP D350 H, FP D355, FP D355 DC, FP D450, FP D455, FP D600, FP D605	<i>Priced per Corona Wire, sold in Sets of 10.</i>
FFPXL04H00	32014602 	Corona Wire 60μ 0.3μ Gold Plated Various Applications Transfer	DP 3520, DP 4520 G, DP 4520 H, DP 6020 G, DP 6020 H DP 3510, DP 4510, DP 6010, FP 7718, FP 7722, FP 7728, FP 7735, FP 7735 MX, FP 7742, FP 7750, FP 7818, FP 7824, FP 7830, FP 7835, FP 7845, FP 7850, FP D250, FP D250 F, FP D350, FP D350 F, FP D350 H, FP D450, FP D455, FP D600, FP D605	<i>Priced per Corona Wire, sold in Sets of 10.</i>
DZTT000676	32023613 	Corona Wire Charge	DP 3510, DP 4510, DP 6010	<i>Priced per Corona Wire, sold in Sets of 10.</i>
FFPEY0004	32375558 	Corona Wire Spool 50 m / Spool 80μ Unpolished Paper Attraction, Transfer Grid Transfer, Separation All Applications Charge	FP C1 XE FP 820, FP 830, FP 3007, FP 3030, FP 3037, FP 3040, FP 4650 FP 1300, FP 1307, FP 1510, FP 1520, FP 1530, FP 1540, FP 1800, FP 1801, FP 1802, FP 2520, FP 2625, FP 3000, FP 3001, FP 3002, FP 3010 R, FP 4520 FP 1570	
FFPEY0040	32375547 	Corona Wire Spool 50 m / Spool 80μ 0.3μ Gold Plated Charge, Subcharge, Paper Disc Charge	FP C1 XE FP 2230, FP 3007, FP 3030, FP 3037, FP 3040, FP 4630, FP 4650, FP 5060	

For use in
Panasonic
 Copiers

Central/Eastern Europe
 Telephone: 31(0)183-696969
 Fax: 31(0)183-629055
 E-mail: order@edc.katun.com

OEM PN	KATUN PN	DESCRIPTION	MODEL NO.
Corona/Charge/Transfer			
FFPM41626652	32375138 	Corona Wire Spool 100 m / Spool 50µ Oxidized All Applications	FP 1100
1067-0759-01	32013991 	Corona Wire 50µ Oxidized Charge, Transfer	FP 1270, FP 1275, FP 1370
N/P/N	32375230 	Corona Wire Spool Platinum alloy clad technology extends corona wire life. 80µ 7.5 m / Spool All Applications	FP 1300, FP 1307, FP 1510, FP 1520, FP 1530, FP 1540, FP 1800, FP 1801, FP 1802, FP 2520, FP 2625, FP 3000, FP 3001, FP 3002, FP 3007, FP 3010 R, FP 3030, FP 3037, FP 3040, FP 4520 Charge FP 1570, FP 2230, FP 4630, FP 5060
FFPEY0051	32011928 	Corona Wire Increased plating thickness enhances corona wire life. 60µ 1.5µ Gold Plated Transfer	FP 1670, FP 1670 A, FP 1680, FP 1780, FP 2080, FP 2670, FP 2680, FP 3270, FP 3380, FP 4080, FP 7117, FP 7121, FP 7127, FP 7133, FP 7140
FFPEY0051	32011927 	Corona Wire 60µ 0.3µ Gold Plated Transfer	FP 1670, FP 1670 A, FP 1680, FP 1780, FP 2080, FP 2670, FP 2680, FP 3270, FP 3380, FP 4080, FP 7117, FP 7121, FP 7127, FP 7133, FP 7140
FFPEY0052	32011930 	Corona Wire Increased plating thickness enhances corona wire life. 60µ 1.5µ Gold Plated Charge, Separation	FP 1670, FP 1670 A, FP 1680, FP 1780, FP 2080, FP 2670, FP 2680, FP 3270, FP 3380, FP 4080, FP 7117, FP 7121, FP 7127, FP 7133, FP 7140
FFPEY0052	32011929 	Corona Wire 60µ 0.3µ Gold Plated Charge, Separation	FP 1670, FP 1670 A, FP 1680, FP 1780, FP 2080, FP 2670, FP 2680, FP 3270, FP 3380, FP 4080, FP 7117, FP 7121, FP 7127, FP 7133, FP 7140
1031-0751-01	32375208 	Corona Wire 60µ 0.3µ Gold Plated Transfer, Separation	FP 6070

*Priced per Set,
10 Corona Wires per Set.*







*Priced per Set,
10 Corona Wires per Set.*

*Priced per Set,
10 Corona Wires per Set.*

*Priced per Set,
10 Corona Wires per Set.*

*Priced per Set,
10 Corona Wires per Set.*

*Priced per Set,
10 Corona Wires per Set.*





OEM PN	KATUN PN	DESCRIPTION	MODEL NO.
Corona/Charge/Transfer			
N/P/N	32375228 	Corona Wire Spool Platinum alloy clad technology extends corona wire life. 60μ 7.5 m / Spool All Applications	FP 6070
N/P/N	32375527 	Corona Wire Spool 50 m / Spool Increased plating thickness enhances corona wire life. 60μ 1.5μ Gold Plated All Applications	FP 6070
N/P/N	32375120 	Corona Wire Spool 50 m / Spool 60μ 0.3μ Gold Plated All Applications	FP 6070
1075-0765-01	32013999 	Corona Wire Cleaning Pads not included. 60μ 0.3μ Gold Plated All Applications	FP 7160
1075-4058-01	32016696 	Charge Corona Grid	FP 7160
1074-0161-01	32375208 	Corona Wire 60μ 0.3μ Gold Plated Pretransfer	FP 7181
1161-4053-01	32017503 	Corona Plate	FP 7760, FP 7781, FP D620

*Priced per Set,
 10 Corona Wires per Set.*

*Priced per Set,
 10 Corona Wires per Set.*

For use in
Panasonic
 Copiers

Central/Eastern Europe
 Telephone: 31(0)183-696969
 Fax: 31(0)183-629055
 E-mail: order@edc.katun.com

OEM PN	KATUN PN	DESCRIPTION	MODEL NO.
Developers			
FQ-ZA10	32014570 	Black Developer 950 g / Bottle 4 Boxes (16 Bottles) per Master Carton	FP 1620, FP 1670, FP 1670 A, FP 1680, FP 1780 <i>Priced per Bottle, sold in Boxes of 4.</i>
FQ-ZA25	32014570 	Black Developer 950 g / Bottle 4 Boxes (16 Bottles) per Master Carton	FP 1620, FP 1670, FP 1670 A, FP 1680, FP 1780, FP 2080, FP 2670, FP 2680, FP 3270, FP 3380, FP 7117, FP 7121, FP 7127, FP 7133 <i>Priced per Bottle, sold in Boxes of 4.</i>
FQ-ZA25	32013784	Black Developer Original 950 g / Bottle	FP 1620, FP 1670, FP 1670 A, FP 1680, FP 1780, FP 2080, FP 2670, FP 2680, FP 3270, FP 3380, FP 7117, FP 7121, FP 7127, FP 7133
FQ-ZA21	32014570 	Black Developer 950 g / Bottle 4 Boxes (16 Bottles) per Master Carton	FP 2080 <i>Priced per Bottle, sold in Boxes of 4.</i>
FQ-ZA20	32014570 	Black Developer 950 g / Bottle 4 Boxes (16 Bottles) per Master Carton	FP 2670, FP 2680, FP 3270, FP 3380 <i>Priced per Bottle, sold in Boxes of 4.</i>
FQ-ZA30	32014570 	Black Developer 950 g / Bottle 4 Boxes (16 Bottles) per Master Carton	FP 4080, FP 7140 <i>Priced per Bottle, sold in Boxes of 4.</i>
FQ-ZF15	32019932	Black Developer Original 630 g / Bottle	FP 7113, FP 7115, FP 7713, FP 7715
FQ-ZK10	32018532	Black Developer Original 650 g / Bottle	FP 7718, FP 7722, FP 7818, FP 7824
FQ-ZK20	32018531	Black Developer Original 750 g / Bottle	FP 7728, FP 7735, FP 7735 MX, FP 7742, FP 7750, FP 7830, FP 7830 DC, FP 7835, FP 7835 MX, FP 7845, FP 7850
FQ-ZL20	32021820	Black Developer Original 750 g / Bottle	FP D250, FP D250 F, FP D350, FP D350 F, FP D350 H, FP D355, FP D355 DC
FQ-ZL30	32021821	Black Developer Original 750 g / Bottle	FP D450, FP D455, FP D600, FP D605

Central/Eastern Europe
Telephone: 31(0)183-696969
Fax: 31(0)183-629055
E-mail: order@edc.katun.com

For use in
Panasonic
Copiers











OEM PN	KATUN PN	DESCRIPTION	MODEL NO.
-----------	-------------	-------------	--------------















Electrical

N/P/N	32010515 	Imaging Unit Fuse	FP 1270, FP 1275, FP 1370	<i>Priced per Bag, 20 Fuses per Bag.</i>
-------	---	-------------------	---------------------------	--

For use in
Panasonic
 Copiers











Central/Eastern Europe
 Telephone: 31(0)183-696969
 Fax: 31(0)183-629055
 E-mail: order@edc.katun.com

OEM PN	KATUN PN	DESCRIPTION	MODEL NO.	
Feed/Delivery				
FFPMA0542	32016660 	Paper Pickup Roller Tire Only	DP 3510, DP 3520, DP 4510, DP 4520 G, DP 4520 H, DP 6010, DP 6020 G, DP 6020 H, FP 7718, FP 7722, FP 7728, FP 7735, FP 7735 MX, FP 7742, FP 7750, FP 7818, FP 7824, FP 7830, FP 7835, FP 7845, FP 7850, FP D250, FP D250 F, FP D350, FP D350 F, FP D350 H, FP D355, FP D355 DC, FP D450, FP D455, FP D600, FP D605, MA- 055, MA- 301	<i>Priced per Tire, sold in Bags of 10.</i>
FFPMA01381	32632525 	Paper Feed Roller Tire Only	FP C1 XE, FP 3007, FP 3030, FP 3037, FP 3040	<i>Priced per Tire, sold in Bags of 10.</i>
1067-3001-02	32014019 	Paper Pickup Roller Tire Only	FP 1270, FP 1275, FP 1370	<i>Priced per Tire, sold in Bags of 10.</i>
FFPMA0158	32636681 	Sheet Bypass Roller Tire Only	FP 1307, FP 1510, FP 1530, FP 1540, FP 1570	<i>Priced per Tire, sold in Bags of 10.</i>
FFPMA0159	32636681 	Paper Feed Roller Tire Only Upper Separation Paper Pickup	FP 1307, FP 1510, FP 1530, FP 1540, FP 1570, FP 1670, FP 1670 A, FP 1780, FP 2670, FP 2680, FP 3270, FP 3380, FP 4080, FP 7117, FP 7121, FP 7127, FP 7133, FP 7140 FP 2080	<i>Priced per Tire, sold in Bags of 10.</i>
FFPMA0161	32636681 	Paper Feed Roller Tire Only	FP 1307, FP 1510, FP 1530, FP 1540, FP 1570, FP 2230, UF- 30	<i>Priced per Tire, sold in Bags of 10.</i>
FFPMA0377	32012878 	Sheet Bypass Paper Transfer Roller Tire Only	FP 1670, FP 1670 A, FP 1680, FP 1780, FP 2080, FP 2670, FP 2680, FP 3270, FP 3380, FP 4080	<i>Priced per Tire, sold in Bags of 10.</i>
FFPMA05031	32011759 	Cassette Paper Feed Tire Tire Only	FP 1670, FP 1670 A, FP 1680, FP 1780, FP 2080, FP 2670, FP 2680, FP 3270, FP 3380, FP 4080, FP 7117, FP 7121, FP 7127, FP 7133, FP 7140, MA- 051, MA- 052, MA- 053	<i>Priced per Tire, sold in Bags of 10.</i>
FFPMA04201	32012298 	Double Feed Prevention Roller Tire Only	FP 1670, FP 1670 A, FP 1680, FP 1780, FP 2080, FP 2670, FP 2680, FP 3270, FP 3380, FP 4080, DS- 22, DS- 22 B, MA- 051, MA- 053, MA- 101, MA- 201	<i>Priced per Tire, sold in Bags of 10.</i>
FFPMA03781	32009694 	Double Feed Prevention Roller Tire Only	FP 1670, FP 1670 A, FP 1780, FP 2080, FP 2670, FP 2680, FP 3270, FP 3380, FP 4080, FP 7117, FP 7121, FP 7127, FP 7133, FP 7140, MADM- 1	<i>Priced per Tire, sold in Bags of 10.</i>
FFPMA03952	32011759 	Cassette Paper Feed Roller Tire Only	FP 1670, FP 1670 A, FP 2670, FP 3270, FP 7117, DS- 22, DS- 22 B, MA- 051, MA- 101, MA- 201	<i>Priced per Tire, sold in Bags of 10.</i>

OEM PN	KATUN PN	DESCRIPTION	MODEL NO.	
Feed/Delivery				
FFPMA04791	32011759 	Cassette Paper Feed Roller Tire Only	FP 1680, FP 1780, FP 2080, FP 2680, FP 3380, FP 4080, FP 7121, FP 7127, FP 7133, FP 7140	<i>Priced per Tire, sold in Bags of 10.</i>
1031-5402-02	32011546 	Paper Feed Roller Tire Only	FP 6070, FP 7181, L- 2060	<i>Priced per Tire, sold in Bags of 5.</i>
1051-5401-01	32012218 	Takeup Roller Tire Only Ribbed Tire	FP 6070, FP 7181, L- 2060	<i>Priced per Tire, sold in Bags of 5.</i>
1075-3051-01	32013024 	Paper Pickup/Feed Roller Tire Only	FP 7160, FP 7760, FP 7781, FP D620, L 3010, L 3020, L- 3000, L- 3005	<i>Priced per Tire, sold in Bags of 10.</i>
4002-3216-01	32021951 	Paper Feed Roller	FP 7160, FP 7760, FP 7781, FP D620, L- 4001, T- 312	<i>Priced per Feed/Sep Roller, sold in Bags of 2.</i>
1261-5402-02	32010188 	Paper Feed Roller Tire Only	FP 7181, F- 800	<i>Priced per Tire, sold in Bags of 4.</i>
FFPMA0541	32016654 	Paper Feed Roller Tire Only	FP 7718, FP 7722, FP 7728, FP 7735, FP 7735 MX, FP 7742, FP 7750, MA- 055, MA- 301	<i>Priced per Tire, sold in Bags of 10.</i>
FFPMA0545	32020764 	Middle Roller	FP 7718, FP 7722, FP 7728, FP 7735, FP 7742, FP 7750	
FFPMA05451	32020764 	Middle Roller	FP 7818, FP 7824, FP 7830, FP 7835, FP 7845, FP 7850, FP D250, FP D350, FP D355, FP D355 DC, FP D450, FP D455, FP D600, FP D605, MADM- 8	
FFPMB0153	32000146 	Original Feed Roller Tire Only	A- 760, A- 770	<i>Priced per Tire, sold in Bags of 10.</i>
1259-5401-03	32011373 	Separation Roller Tire Only	A- 780	<i>Priced per Tire, sold in Bags of 10.</i>
1259-5402-04	32011373 	Paper Feed Roller Tire Only	A- 780	<i>Priced per Tire, sold in Bags of 10.</i>
FFPMA0489	32010819 	Double Feed Prevention Roller Tire Only	A- 880	
FFPMA0490	32010818 	Original Pickup Roller Tire Only	A- 880	
PF2214P471A	32019943 	Original Pickup Roller Ribbed Tire For Document Feeder	A- 888	<i>Priced per Pickup Roller, sold in Bags of 10.</i>

For use in
Panasonic
 Copiers

Central/Eastern Europe
 Telephone: 31(0)183-696969
 Fax: 31(0)183-629055
 E-mail: order@edc.katun.com

OEM PN	KATUN PN	DESCRIPTION	MODEL NO.	
Feed/Delivery				
PF2217K050A	32019944 	Double Feed Prevention Roller	A- 888	
PF2217P316A	32020086 	Original Feed Roller Tire Only	A- 888	<i>Priced per Tire, sold in Bags of 5.</i>
4408-0751-01	32023916 	Separation Pad	A- 910, A- 920	
4426-3128-02	32020979 	Original Feed Roller	A- 910, A- 920, A- 990	<i>Priced per Feed/Sep Roller, sold in Bags of 4.</i>
4426-3128-02	32011858 	Original Feed Roller Tire Only	A- 910, A- 920, A- 990	<i>Priced per Tire, sold in Bags of 4.</i>
FFPMA03972	32012801 	Paper Pickup Roller Tire Only	DS- 22, DS- 22 B, MA- 051, MA- 101, MA- 201	<i>Priced per Tire, sold in Bags of 10.</i>
FFPMA03971	32017777 	Paper Pickup Roller Tire Only	MA- 051	<i>Priced per Tire, sold in Bags of 10.</i>
FFPMA0504	32017777 	Paper Pickup Tire Tire Only	MA- 051, MA- 052	<i>Priced per Tire, sold in Bags of 10.</i>
FFPMA03973	32017777 	Paper Pickup Roller Tire Only	MA- 052	<i>Priced per Tire, sold in Bags of 10.</i>
FFPMA04811	32011759 	Paper Feed Roller Tire Only	MA- 052	<i>Priced per Tire, sold in Bags of 10.</i>
1231-5402-02	32011312 	Paper Feed Roller Tire Only	T- 303, T- 312, UF- 60	<i>Priced per Tire, sold in Bags of 5.</i>











Central/Eastern Europe
Telephone: 31(0)183-696969
Fax: 31(0)183-629055
E-mail: order@edc.katun.com







For use in
Panasonic
Copiers

OEM PN	KATUN PN	DESCRIPTION	MODEL NO.
Filters			
1155-3611-01	32023034 	Vacuum Transport Ozone Filter	FP D620

For use in
Panasonic
 Copiers

Central/Eastern Europe
 Telephone: 31(0)183-696969
 Fax: 31(0)183-629055
 E-mail: order@edc.katun.com





OEM PN	KATUN PN	DESCRIPTION	MODEL NO.
Fuser Cleaning			
FFPTM0432	32008787 	Web Supply Roller	DP 3510, DP 4510, DP 6010, FP 1670, FP 1670 A, FP 1780, FP 2080, FP 2670, FP 2680, FP 3270, FP 3380, FP 4080, FP 7117, FP 7121, FP 7127, FP 7133, FP 7140, FP 7718, FP 7722, FP 7728, FP 7735, FP 7735 MX, FP 7742, FP 7750, FP 7818, FP 7824, FP 7830, FP 7835, FP 7845, FP 7850, FP D250, FP D250 F, FP D350, FP D350 F, FP D350 H, FP D355, FP D355 DC, FP D450, FP D455, FP D600, FP D605
1067-5729-02	32011281 	Fuser Cleaning Roller	FP 1270, FP 1275
1132-5729-01	32013217 	Fuser Cleaning Roller	FP 1370
FFPKM01343	32008787 	Web Supply Roller	FP 1670, FP 1670 A, FP 1780, FP 2080, FP 2670, FP 2680, FP 3270, FP 3380, FP 4080, FP 7117, FP 7121, FP 7127, FP 7133, FP 7140, FP 7718, FP 7722, FP 7728, FP 7735, FP 7742, FP 7750, FP D250, FP D350
FFPKM0271	32008787 	Web Supply Roller	FP 1680
1051-1701-01	32632581 	Wave Roller Cleaning Belt	FP 6070
1051-1716-01	32632305 	Oil Supply Roller For use with mod. kit only.	FP 6070, FP 7160, FP 7760, FP 7781, FP D620
1074-5787-01	32012597 	Web Supply Roller	FP 7160
1075-5751-01	32023551 	Web Supply Pressure Roller	FP 7160, FP 7181, FP 7760, FP 7781, FP D620
1145-5801-01	32014814 	Web Supply Roller	FP 7181, FP 7760, FP 7781, FP D620

OEM PN	KATUN PN	DESCRIPTION	MODEL NO.
Kits			
DQ-RK05A	32022558 	Toner Remanufacturing Kit 410 g / Bottle Kit Contains: <ul style="list-style-type: none"> • (6) Toner Cap • (1) Nozzle • (12) Screw • (6) Poly Bag • (6) Refill Count Label • (12) Magnetic Roller Gap Ring • (6) Magnetic Roller Cleaning Sponge • (1) 5K Refill Instructions 1 Carton (6 Bottles) per Master Carton	DP 130 P, DP 135, DP 135 FP, DP 135 P, DP 150, DP 150 A, DP 150 FP, DP 150 P <i>Priced per Bottle, sold in Cartons of 6.</i>
DQ-RK18B	32022557 	Black Toner Refill Kit 585 g / Bottle Kit Contains: <ul style="list-style-type: none"> • (1) Nozzle • (6) Waste Toner Bottle • (6) Poly Bag • (6) Refill Count Label 1 Carton (12 Bottles) per Master Carton	DP 2000, DP 2000 P, DP 2500, DP 2500 D, DP 2500 P, DP 3000, DP 3000 E <i>Priced per Bottle, sold in Cartons of 12.</i>
1075-0902-01	32014426 	Drum Cleaning Blade Kit Blade only	FP 7160, FP 7760, FP 7781
1074-0904-01	32010547 	Drum Cleaning Blade Kit	FP 7181, FP D620
N/P/N	32018832 	Cassette PM Kit Kit Contains: <ul style="list-style-type: none"> • (2) Paper Feed Tire • (1) Paper Pickup Tire 	FP 7718, FP 7722, FP 7728, FP 7735, FP 7742, FP 7750, MA- 055, MA- 301
FQ-SKA888	32020159 	Document Feeder PM Kit Kit Contains: <ul style="list-style-type: none"> • (1) Original Document Feed Belt • (1) Original Separation Roller • (1) Original Pickup Roller • (1) Original Feed Tire 	A- 888
FQ-SKMA055	32018569 	Cassette PM Kit Kit Contains: <ul style="list-style-type: none"> • (20) Paper Feed Tire • (10) Paper Pickup Tire 	MA- 055, MA- 301









For use in
Panasonic
 Copiers

Central/Eastern Europe
 Telephone: 31(0)183-696969
 Fax: 31(0)183-629055
 E-mail: order@edc.katun.com

OEM PN	KATUN PN	DESCRIPTION	MODEL NO.
Lamps			
9352-2010-22	32021078 	Heater Lamp 220/240V 800W	FP 1270, FP 1275, FP 1370
E16V025WN2A	32021166 	Exposure Lamp 160V 250W	FP 1670, FP 1670 A, FP 1680, FP 1780, FP 2080, FP 2670, FP 2680, FP 3270, FP 3380, FP 4080, FP 7113, FP 7115, FP 7117, FP 7121, FP 7127, FP 7133, FP 7140, FP 7713, FP 7715, FP 7718, FP 7722, FP 7728, FP 7735, FP 7735 MX, FP 7742, FP 7750, FP 7818, FP 7824, FP 7830, FP 7835, FP 7845, FP 7850
JK16V025WF67	32021166 	Exposure Lamp 160V 250W	FP 1670, FP 1670 A, FP 1680, FP 1780, FP 2080, FP 2670, FP 2680, FP 3270, FP 3380, FP 4080, FP 7117, FP 7121, FP 7127, FP 7133, FP 7140
9351-2311-01	32014703 	Exposure Lamp 160V 250W	FP 7160, FP 7760

OEM PN	KATUN PN	DESCRIPTION	MODEL NO.
--------	----------	-------------	-----------











Memory Upgrades



DA-SM16B	32020009 	Memory Upgrade Board- 16 MB Printer Memory Upgrade	DP 135 FP, DP 135 P, DP 150, DP 150 A, DP 150 FP, DP 150 P, DP 1810 F, DP 1810 P, DP 2000, DP 2000 P, DP 2010 E, DP 2310, DP 2500, DP 2500 D, DP 2500 P, DP 3010, DP 3510, DP 4510, DP 6010
DA-SM28B	32020011 	Memory Upgrade Board-128 MB Printer Memory Upgrade	DP 1810 F, DP 1810 P, DP 2000, DP 2000 P, DP 2010 E, DP 2310, DP 2500, DP 2500 D, DP 2500 P, DP 3010, DP 3510, DP 4510, DP 6010
DA-SM08B	32020010 	Memory Upgrade Board- 8 MB Printer Memory Upgrade	DP 1810 F, DP 1810 P, DP 2000, DP 2000 P, DP 2010 E, DP 2500, DP 2500 D, DP 2500 P
FA-DM16	32018416 	Memory Upgrade Board- 16 MB Copier Memory	FP D250, FP D250 F, FP D350, FP D350 F, FP D350 H, FP D355, FP D355 DC, FP D450, FP D455, FP D600, FP D605
FA-DM32	32018417 	Memory Upgrade Board- 32 MB Copier Memory	FP D250, FP D250 F, FP D350, FP D350 F, FP D350 H, FP D355, FP D355 DC, FP D450, FP D455, FP D600, FP D605
FA-PM16	32018418 	Memory Upgrade Board- 16 MB Printer Controller Memory	FP D250, FP D250 F, FP D350, FP D350 F, FP D350 H, FP D355, FP D355 DC, FP D450, FP D455, FP D600, FP D605
FA-PM32	32018426 	Memory Upgrade Board- 32 MB Printer Controller Memory	FP D250, FP D250 F, FP D350, FP D350 F, FP D350 H, FP D355, FP D355 DC, FP D450, FP D455, FP D600, FP D605

For current memory upgrade pricing, visit our on-line catalogue at www.katun.com or contact your customer service representative.

For use in
Panasonic
 Copiers







Central/Eastern Europe
 Telephone: 31(0)183-696969
 Fax: 31(0)183-629055
 E-mail: order@edc.katun.com



















OEM PN	KATUN PN	DESCRIPTION	MODEL NO.	
Photoreceptors				
DQ-H045B	32019901 	OPC Drum 20 Drums per Master Carton	DP 1510 P, DP 1810 F, DP 1810 P, DP 2000, DP 2010 E, DP 2500, DP 2500 D, DP 2500 P, DP 3000, DP 3000 E	<i>Priced per Drum, sold per Drum.</i>
DQ-H030B	32019901 	OPC Drum 20 Drums per Master Carton	DP 2000, DP 2000 P, DP 2500, DP 2500 D, DP 2500 P	<i>Priced per Drum, sold per Drum.</i>
FQ-H500	32503135 	SeTe Drum 6 Drums per Master Carton	FP 1100	<i>Priced per Drum, sold per Drum.</i>
1067-0293-01	32010288 	OPC Drum 50 Drums per Master Carton	FP 1270, FP 1275, FP 1370	<i>Priced per Drum, sold per Drum.</i>
FQ-HA10	32023204 	OPC Drum 12 Drums per Master Carton	FP 1620, FP 1670, FP 1670 A, FP 1680, FP 1780, FP 2080, FP 2670, FP 2680, FP 3270, FP 3380, FP 7117, FP 7121, FP 7127, FP 7133	<i>Priced per Drum, sold per Drum.</i>
FQ-HA10	32017769	OPC Drum Access By Katun 12 Drums per Master Carton	FP 1620, FP 1670, FP 1670 A, FP 1680, FP 1780, FP 2080, FP 2670, FP 2680, FP 3270, FP 3380, FP 7117, FP 7121, FP 7127, FP 7133	<i>Priced per Drum, sold per Drum.</i>
FQ-HA30	32014379 	OPC Drum 12 Drums per Master Carton	FP 4080, FP 7140	<i>Priced per Drum, sold per Drum.</i>
FQ-H770 <i>Final Inventory</i>	32507371 	As2Se3 Drum without Drum Dry Heater or Drum Flanges 6 Drums per Master Carton	FP 6070	<i>Priced per Drum, sold per Drum.</i>
FQ-HF13	32013065 	OPC Drum 20 Drums per Master Carton	FP 7113, FP 7115, FP 7713, FP 7715	<i>Priced per Drum, sold per Drum.</i>
FQ-HE60	32012583 	OPC Drum 12 Drums per Master Carton	FP 7160	<i>Priced per Drum, sold per Drum.</i>
FQ-HE60	32017558	OPC Drum Access By Katun 6 Drums per Master Carton	FP 7160	<i>Priced per Drum, sold per Drum.</i>
FQ-HE81	32016825 	OPC Drum 12 Drums per Master Carton	FP 7181	<i>Priced per Drum, sold per Drum.</i>
FQ-HK10	32018917 	OPC Drum 12 Drums per Master Carton	FP 7718, FP 7722, FP 7818, FP 7824	<i>Priced per Drum, sold per Drum.</i>

OEM PN	KATUN PN	DESCRIPTION	MODEL NO.	
Photoreceptors				
FQ-HK20	32018917 	OPC Drum 12 Drums per Master Carton	FP 7728, FP 7735, FP 7735 MX, FP 7742, FP 7750, FP 7830, FP 7830 DC, FP 7835, FP 7835 MX, FP 7845, FP 7850	<i>Priced per Drum, sold per Drum.</i>
FQ-HE70	32016824 	OPC Drum 12 Drums per Master Carton	FP 7760, FP 7781	<i>Priced per Drum, sold per Drum.</i>
FQ-HE70	32017559	OPC Drum Access By Katun 6 Drums per Master Carton	FP 7760, FP 7781	<i>Priced per Drum, sold per Drum.</i>
FQ-HL20	32021663 	OPC Drum 12 Drums per Master Carton	FP D250, FP D250 F, FP D350, FP D350 F, FP D350 H, FP D355, FP D355 DC, FP D450, FP D455, FP D600, FP D605	<i>Priced per Drum, sold per Drum.</i>
1155-0292	32018520	OPC Drum Access By Katun 6 Drums per Master Carton	FP D620	<i>Priced per Drum, sold per Drum.</i>

For use in
Panasonic
 Copiers













Central/Eastern Europe
 Telephone: 31(0)183-696969
 Fax: 31(0)183-629055
 E-mail: order@edc.katun.com

OEM PN	KATUN PN	DESCRIPTION	MODEL NO.
Picker Fingers			
FFPM42528100	32013100 	Picker Finger	FP 1100
			<i>Priced per Picker Finger, sold in Packages of 10.</i>
1067-5710-01	32013182 	Picker Finger	FP 1270, FP 1275, FP 1370
			<i>Priced per Picker Finger, sold in Bags of 10.</i>
FFPLK0231	32013774 	Lower Picker Finger	FP 1670, FP 1670 A, FP 1680, FP 1780, FP 2080, FP 2670, FP 2680, FP 3270, FP 3380, FP 4080, FP 7117, FP 7121, FP 7127, FP 7133, FP 7140, FP 7718, FP 7722, FP 7728, FP 7735, FP 7735 MX, FP 7742, FP 7750, FP 7818, FP 7824, FP 7830, FP 7835, FP 7845, FP 7850, FP D250 F, FP D350, FP D350 F, FP D350 H, FP D355, FP D355 DC, FP D450, FP D455, FP D600, FP D605
			<i>Priced per Picker Finger, sold in Bags of 10.</i>
FFPLK0230	32013254 	Upper Picker Finger	FP 1670, FP 1670 A, FP 1680, FP 1780, FP 2080, FP 2670, FP 2680, FP 3270, FP 3380, FP 4080, FP 7117, FP 7121, FP 7127, FP 7133, FP 7140, FP 7718, FP 7722, FP 7728, FP 7735, FP 7735 MX, FP D250, FP D250 F, FP D350, FP D350 F, FP D350 H, FP D355, FP D355 DC
			<i>Priced per Picker Finger, sold in Packages of 10.</i>
1074-5701-01	32015620 	Upper Picker Finger	FP 6070, FP 7160, FP 7181, FP 7760, FP 7781, FP D620
			<i>Priced per Picker Finger, sold in Packages of 6.</i>
1031-4706-01	32242358 	Lower Picker Finger	FP 6070, FP 7181
			<i>Priced per Picker Finger, sold in Bags of 10.</i>
1075-5757-01	32242358 	Lower Picker Finger	FP 7160, FP 7760, FP 7781, FP D620
			<i>Priced per Picker Finger, sold in Bags of 10.</i>

OEM PN	KATUN PN	DESCRIPTION	MODEL NO.
Rollers, Fuser/Heat			
DZLA000213	32019859 	Upper Fuser Roller	DP 2000, DP 2000 P, DP 2500, DP 2500 D, DP 2500 P, DP 3000, DP 3000 E
DZLA000266	32021952 	Upper Fuser Roller	DP 4510, DP 4520 G, DP 4520 H, DP 6010, DP 6020 G, DP 6020 H
FFPM71620030	32636395 	Upper Fuser Roller DURAPREM™ II	FP 1100
1067-5701-01	32000813 	Upper Fuser Roller DURACON™ II	FP 1270, FP 1275
1132-5701-01	32000813 	Upper Fuser Roller DURACON™ II	FP 1370
FFPMA0359	32010628 	Upper Fuser Roller DURACON™ II	FP 1670, FP 1670 A, FP 1680, FP 1780, FP 2080, FP 7117, FP 7121
1031-1708-02	32012814 	Upper Fuser Roller ALUMANA™ Patented TEFLON® coating with reinforcing oxides extends life.	FP 6070
FFPMA05242	32014248 	Upper Fuser Roller DURACON™ II	FP 7113, FP 7115, FP 7713, FP 7715
1075-5768-01	32023405 	Upper Fuser Roller TRITON BLUE™	FP 7160, FP 7760, FP 7781, FP D620
1074-5714-02	32011315 	Upper Fuser Roller ALUMANA™ Patented TEFLON® coating with reinforcing oxides extends life.	FP 7181
FFPMA0574	32015222 	Upper Fuser Roller OEM Type	FP 7718, FP 7722, FP 7818, FP 7824
FFPMA0574	32018527 	Upper Fuser Roller	FP 7718, FP 7722, FP 7818, FP 7824
FFPMA0577	32015223 	Upper Fuser Roller OEM Type	FP 7728, FP 7735, FP 7735 MX, FP 7830, FP 7835, FP D250, FP D250 F, FP D350, FP D350 F, FP D350 H, FP D355, FP D355 DC
FFPMA0577	32018528 	Upper Fuser Roller	FP 7728, FP 7735, FP 7735 MX, FP 7830, FP 7835, FP D250, FP D250 F, FP D350, FP D350 F, FP D350 H, FP D355, FP D355 DC
FFPMA0566	32015224 	Upper Fuser Roller OEM Type	FP 7742, FP 7845, FP D450, FP D455, FP D600, FP D605
FFPMA0566	32018529 	Upper Fuser Roller	FP 7742, FP 7845, FP D450, FP D455, FP D600, FP D605
FFPMA0590	32015225 	Upper Fuser Roller OEM Type	FP 7750, FP 7850
FFPMA0590	32018530 	Upper Fuser Roller	FP 7750, FP 7850



For use in
Panasonic
 Copiers

Central/Eastern Europe
 Telephone: 31(0)183-696969
 Fax: 31(0)183-629055
 E-mail: order@edc.katun.com

OEM PN	KATUN PN	DESCRIPTION	MODEL NO.
Rollers, Pressure			
FFPMA06901	32022933 	Lower Pressure Roller MICROSLEEVE™	DP 130 P, DP 135, DP 135 FP, DP 135 P, DP 150, DP 150 A, DP 150 FP, DP 150 P
DZLA000214	32022963 	Lower Pressure Roller MICROSLEEVE™	DP 2000, DP 2000 P, DP 2500, DP 2500 D, DP 2500 P, DP 3000, DP 3000 E
DZLA000302	32023603 	Lower Pressure Roller MICROSLEEVE™	DP 3510, DP 3520
DZHP007236	32023550 	Lower Pressure Roller Assembly MICROSLEEVE™ with Ball Bearings	DP 4510, DP 4520 G, DP 4520 H, DP 6010, DP 6020 G, DP 6020 H
1067-5704-01	32009347 	Lower Pressure Roller	FP 1270, FP 1275, FP 1370
FFPMA03581	32000402 	Lower Pressure Roller MICROSLEEVE™	FP 1670, FP 1670 A, FP 1680, FP 1780, FP 2080, FP 7117, FP 7121, FP 7718, FP 7722, FP 7818, FP 7824
FFPMA04181	32000403 	Lower Pressure Roller MICROSLEEVE™	FP 2670, FP 2680, FP 3270, FP 3380, FP 4080, FP 7127, FP 7133, FP 7140, FP 7728, FP 7735, FP 7735 MX, FP 7830, FP 7835, FP D250, FP D250 F, FP D350, FP D350 F, FP D350 H, FP D355, FP D355 DC
1051-1713-01 <i>Final Inventory</i>	32636320 	Lower Pressure Roller	FP 6070
FFPMA0523	32016959 	Lower Pressure Roller	FP 7113, FP 7115, FP 7713, FP 7715
1129-2021-01	32011120	Lower Pressure Roller MICROSLEEVE™ Access By Katun	FP 7160, FP 7760, FP 7781, FP D620
1145-5802-01	32019176 	Lower Pressure Roller MICROSLEEVE™	FP 7181
FFPMA03582	32000402 	Lower Pressure Roller MICROSLEEVE™	FP 7718, FP 7722
FFPMA0565	32021565 	Lower Pressure Roller	FP 7742, FP 7750, FP 7845, FP 7850, FP D450, FP D455, FP D600, FP D605

Central/Eastern Europe
Telephone: 31(0)183-696969
Fax: 31(0)183-629055
E-mail: order@edc.katun.com







For use in
Panasonic
Copiers

OEM PN	KATUN PN	DESCRIPTION	MODEL NO.
Thermal Control Devices			
9334-1310-31	32013233 	Thermoswitch	FP 7160, FP 7760, FP 7781, FP D620
9372-2710-31	32017289 	Upper Thermistor	FP 7160, FP 7760, FP 7781, FP D620

For use in
Panasonic
 Copiers

Central/Eastern Europe
 Telephone: 31(0)183-696969
 Fax: 31(0)183-629055
 E-mail: order@edc.katun.com

OEM PN	KATUN PN	DESCRIPTION	MODEL NO.	
Toners/Toner Cartridges				
DQ-RK05A	32022558 	Toner Remanufacturing Kit 410 g / Bottle Kit Contains: <ul style="list-style-type: none"> • (6) Toner Cap • (1) Nozzle • (12) Screw • (6) Poly Bag • (6) Refill Count Label • (12) Magnetic Roller Gap Ring • (6) Magnetic Roller Cleaning Sponge • (1) 5K Refill Instructions 1 Carton (6 Bottles) per Master Carton	DP 130 P, DP 135, DP 135 FP, DP 135 P, DP 150, DP 150 A, DP 150 FP, DP 150 P	<i>Priced per Bottle, sold in Cartons of 6.</i>
DQ-TU10C	32023339 	Black Toner 600 g / Cartridge Includes: <ul style="list-style-type: none"> • (6) Waste Toner Bottle 1 Box (6 Cartridges) per Master Carton	DP 1510 P, DP 1810 F, DP 1810 P, DP 2010 E	<i>Priced per Cartridge, sold in Boxes of 6.</i>
DQ-RK18B	32022557 	Black Toner Refill Kit 585 g / Bottle Kit Contains: <ul style="list-style-type: none"> • (1) Nozzle • (6) Waste Toner Bottle • (6) Poly Bag • (6) Refill Count Label 1 Carton (12 Bottles) per Master Carton	DP 2000, DP 2000 P, DP 2500, DP 2500 D, DP 2500 P, DP 3000, DP 3000 E	<i>Priced per Bottle, sold in Cartons of 12.</i>
FQ-TA10	32015311 	Black Toner 290 g / Cartridge Includes: <ul style="list-style-type: none"> • (6) Waste Toner Bottle 6 Boxes (36 Cartridges) per Master Carton	FP 1620, FP 1670, FP 1670 A, FP 1780	<i>Priced per Cartridge, sold in Boxes of 6.</i>
FQ-TA10	32013670	Black Toner Original 290 g / Cartridge	FP 1620, FP 1670, FP 1670 A, FP 1780	<i>Priced per Cartridge, sold in Boxes of 6.</i>
FQ-TA19	32015312 	Black Toner 290 g / Cartridge Includes: <ul style="list-style-type: none"> • (3) Waste Toner Bottle 6 Boxes (36 Cartridges) per Master Carton	FP 1680, FP 2080, FP 7117, FP 7121	<i>Priced per Cartridge, sold in Boxes of 6.</i>
FQ-TA20	32015310 	Black Toner 500 g / Cartridge Includes: <ul style="list-style-type: none"> • (6) Waste Toner Bottle 1 Box (6 Cartridges) per Master Carton	FP 2670, FP 2680, FP 3270, FP 3380, FP 7127, FP 7133	<i>Priced per Cartridge, sold in Boxes of 6.</i>

OEM PN	KATUN PN	DESCRIPTION	MODEL NO.	
Toners/Toner Cartridges				
FQ-TA30	32015309 	Black Toner 500 g / Cartridge Includes: • (6) Waste Toner Bottle 1 Box (6 Cartridges) per Master Carton	FP 4080, FP 7140	<i>Priced per Cartridge, sold in Boxes of 6.</i>
FQ-TF15	32014631	Black Toner Original 185 g / Cartridge • (2) Waste Toner Bottle • (2) Cleaning Pads	FP 7113, FP 7115, FP 7713, FP 7715	<i>Priced per Cartridge, sold in Boxes of 2.</i>
FQ-TF15	32019864	Black Toner Access By Katun 185 g / Cartridge • (2) Waste Toner Bottle • (2) Cleaning Pads 1 Box (2 Cartridges) per Master Carton	FP 7113, FP 7115, FP 7713, FP 7715	<i>Priced per Cartridge, sold in Boxes of 2.</i>
FQ-TF15	32020775	Black Toner Access By Katun 185 g / Cartridge Waste Toner Bottles and Cleaning Pads Not Included 1 Box (2 Cartridges) per Master Carton	FP 7113, FP 7115, FP 7713, FP 7715	<i>Priced per Cartridge, sold in Boxes of 2.</i>
FQ-TE60	32019871 	Black Toner 1750 g / Cartridge 4 Cartridges per Master Carton	FP 7160	<i>Priced per Cartridge, sold per Cartridge.</i>
FQ-TK10	32018891 	Black Toner 462 g / Cartridge Includes: • (6) Waste Toner Bottle 1 Box (6 Cartridges) per Master Carton	FP 7718, FP 7722, FP 7818, FP 7824	<i>Priced per Cartridge, sold in Boxes of 6.</i>
FQ-TK10	32018521	Black Toner Original 462 g / Cartridge	FP 7718, FP 7722, FP 7818, FP 7824	<i>Priced per Cartridge, sold in Boxes of 6.</i>
FQ-TK20	32018892 	Black Toner 660 g / Cartridge 1 Box (6 Cartridges) per Master Carton	FP 7728, FP 7735, FP 7735 MX, FP 7742, FP 7750, FP 7830, FP 7830 DC, FP 7835, FP 7835 MX, FP 7845, FP 7850	<i>Priced per Cartridge, sold in Boxes of 6.</i>
FQ-TK20	32018522	Black Toner Original 660 g / Cartridge	FP 7728, FP 7735, FP 7735 MX, FP 7742, FP 7750, FP 7830, FP 7830 DC, FP 7835, FP 7835 MX, FP 7845, FP 7850	<i>Priced per Cartridge, sold in Boxes of 6.</i>
FQ-TE70	32019871 	Black Toner 1750 g / Cartridge 4 Cartridges per Master Carton	FP 7760	<i>Priced per Cartridge, sold per Cartridge.</i>
FQ-TL20	32019753 	Black Toner 710 g / Cartridge 1 Box (6 Cartridges) per Master Carton	FP D250, FP D250 F, FP D350, FP D350 F, FP D350 H, FP D355, FP D355 DC	<i>Priced per Cartridge, sold in Boxes of 6.</i>



For use in
Panasonic
Copiers

Central/Eastern Europe
Telephone: 31(0)183-696969
Fax: 31(0)183-629055
E-mail: order@edc.katun.com

OEM PN	KATUN PN	DESCRIPTION	MODEL NO.
-----------	-------------	-------------	--------------

Toners/Toner Cartridges

FQ-TL24	32019754 	Black Toner 850 g / Cartridge 1 Box (6 Cartridges) per Master Carton	FP D450, FP D455, FP D600, FP D605 <i>Priced per Cartridge, sold in Boxes of 6.</i>
---------	---	---	--

OEM PN	KATUN PN	DESCRIPTION	MODEL NO.
Waste Toner Containers			
FFPQA0150	32015012 	Waste Toner Bottle	FP 1670, FP 1670 A, FP 1680, FP 1780, FP 2080, FP 2670, FP 2680, FP 3270, FP 3380, FP 4080, FP 7117, FP 7121, FP 7127, FP 7133, FP 7140
1075-5655-03	32022310 	Toner Collection Bottle	FP 7160, FP 7760, FP 7781, FP D620
FQ-BA10	32020918 	Waste Toner Bottle	FP 7728, FP 7735, FP 7735 MX, FP 7742, FP 7750, FP 7830, FP 7830 DC, FP 7835, FP 7835 MX, FP 7845, FP 7850, FP D250, FP D250 F, FP D350, FP D350 F, FP D350 H, FP D355, FP D355 DC, FP D450, FP D455, FP D600, FP D605

General Information

Credit Terms and Ordering Information

Credit Terms

Standard credit terms are net-30-days from date of invoice. To open a net-30-day account, please contact the Katun Credit Department. Until your credit application is approved, orders will be shipped upon receipt of cash in advance or a confirmed, Sight Draft, or via C.O.D. (Nominal C.O.D. handling charges will apply.)

Katun offers a 3% cash-with-order (CWO) discount. Katun will calculate the 3% discount, promptly inform you of the total charges, and ship your order immediately upon receipt of your payment.

Place all orders with Katun (E.D.C.) B.V. via:

- Telephone: 31(0) 183–696969
- Fax: 31(0) 183–629055
- E-mail: order@edc.katun.com
- Address:

Katun (E.D.C.) B.V.
Edisonweg 44
4207 HG Gorinchem
The Netherlands

Reference Katun part numbers on all orders.

Prices are in Euro, EX WORKS Gorinchem, The Netherlands.

Katun business hours are from 8:30 to 17.00 hours.

Katun has a € 350 minimum order. A € 35 charge will be added to orders under the minimum.

Wire transfer funds to:

ABN–AMRO Bank
Daalsesingel 71
Postbus 2059
3500 GB Utrecht
The Netherlands
Account Number: 55 70 74 134
Swift I.D.: ABN ANL 2A
IBAN: NL51ABNA0557074134

General Shipping Information and Product Return Policies

Shipping and Handling

Katun can provide you with alternatives for shipping. We will attempt to select the most convenient and cost-effective carrier for you. However, if you have a preferred carrier, please inform your Katun Customer Service Representative.



Central/Eastern Europe

Telephone: 31(0)183-696969

Fax: 31(0)183-629055

E-mail: order@edc.katun.com

Hazardous material shipments will be billed accordingly. A nominal handling charge is incorporated into our shipping costs.

Product Return Policies

- Katun **must** preauthorize all returns. For return procedures and a return, contact the Customer Service Department at 31(0) 183–696969.
- Toner, toner cartridges, digital duplicator inks and masters, and thermal transfer ribbons with personalized labels cannot be returned to Katun for credit unless a valid warranty claim exists.
- Returns and refused shipments are subject to a minimum 10% restocking charge.
- With the exception of warranty claims, merchandise returned more than 90 days from the invoice date will not be accepted.
- Merchandise which has been written on, marked, relabeled, or placed in other than original Katun packaging will not be accepted.
- All warranty claims submitted to Katun *must* be accompanied by a completed Distributor Choice Warranty Claim Form (included in this catalog). Customers must indicate a warranty choice on the form:
 - (a) Technical Evaluation/ Replacement or technical Evaluation/ Credit: Ship the product and the completed form to:

Katun (E.D.C.) B.V.
Edisonweg 44
4207 HG
Gorinchem
The Netherlands
 - (b) Automatic Replacement: send the completed form to your customer service representative.

Allgemeine Hinweise

Zahlungsbedingungen und Bestellinformationen

Die übliche Zahlungsweise ist bar innerhalb von 30 Tagen ab Rechnungsdatum. Zur Eröffnung eines Kontos wenden Sie sich bitte an die Katun Kreditabteilung. Bis zur Gewährung Ihres Kredits erfolgt der Versand von Bestellungen bei Vorkasse oder bei Erhalt eines bestätigten, Sichtwechsel oder gegen Nachnahme (unter Berechnung einer geringen Nachnahmegebühr).

Katun gewährt 3 % Skonto für Barzahlung bei Bestellung. Katun wird den Skontobetrag errechnen, Ihnen den Gesamtbetrag mitteilen und Ihre Bestellung unverzüglich nach Erhalt Ihrer Zahlung zum Versand aufgeben.

Bitte richten Sie alle Bestellungen an Katun (E.D.C.) B.V. unter:

- **Telefon: 31 (0) 183–696969**
- **Fax: 31 (0) 183–629055**
- **E-mail: order@edc.katun.com**
- **Adresse:**

Katun (E.D.C.) B.V.
Edisonweg 44
NL-4207 HG Gorinchem
Niederlande

Bitte bei allen Bestellungen die Katun Artikelnummern angeben. Preise verstehen sich in Euro, ab Werk Gorinchem, Niederlande.

Katun Geschäftszeit ist 8.30 - 17.00 Uhr. Für alle Bestellungen gilt ein Mindestbestellwert von € 350. Bei Bestellungen unter dem Mindestbestellwert wird ein Zuschlag von €35 berechnet.

Bankverbindung:

ABN AMRO Bank
Daalsesingel 71
Postbus 2059
NL-3500 GB Utrecht
Niederlande
Kontonummer: 55 70 74 134
Bankleitzahl: ABN ANL 2A
IBAN: NL51ABNA0557074134

Versand und Warenrücksendung

Bearbeitung und Versand

Katun bietet verschiedene Versandmethoden an. Wir bemühen uns, die für Sie günstigste und praktischste Versandart zu wählen. Falls Sie eine bestimmte Versandart/Firma vorziehen, teilen Sie dies bitte Ihrem Katun Repräsentanten mit.

Central/Eastern Europe

Telephone: 31(0)183-696969

Fax: 31(0)183-629055

E-mail: order@edc.katun.com

Versandkosten für Gefahrgüter werden entsprechend berechnet. Eine geringe Bearbeitungsgebühr ist in unseren Versandgebühren enthalten.

Warenrücksendung

- Nur von Katun vorher genehmigte Waren- rücksendungen können bearbeitet werden. Bitte lassen Sie sich vom Kundendienst unter der Telefonnummer 31 (0) 183-696969 genaue Anweisungen geben.
- Bei Warenrücksendungen werden 10 % Rücknahmegebühren in Abzug gebracht.
- Toner, Drucker-/Faxkartuschen, Tinten für digitale Duplikatoren sowie Thermo-Transfer-Bänder mit Firmenetiketten sind vom Umtausch ausgeschlossen, es sei denn, es liegt ein Garantiefall vor.
- Ware, die nach Ablauf von 90 Tagen ab Rechnungsdatum zurückgeschickt wird, kann nicht zurückgenommen werden (mit Ausnahme von Reklamationen).
- Ware, deren Verpackung markiert, etikettiert oder beschriftet wurde, oder Ware ohne Originalverpackung kann nicht zurückgenommen werden.
- Alle Garantieansprüche müssen von einem ausgefüllten Händler -Garantieformular begleitet sein (Formular in diesem Katalog enthalten). Geben Sie Ihren Regulierungswunsch auf dem Formular an:
 - (a) Technische Bewertung/Ersatz oder Technische Bewertung/Gutschrift: schicken Sie das Produkt und das vollständig ausgefüllte Formular an:

Katun (E.D.C.) B.V.
Edisonweg 44
NL-4207 HG Gorinchem
Niederlande
 - (b) Ersatz ohne Bewertung: schicken Sie das vollständig ausgefüllte Formular an Ihren Ansprechpartner der Auftragsbearbeitung.

DISTRIBUTOR CHOICE WARRANTY CLAIM FORM

Please print all information. For prompt processing of your claim, please complete all sections. Your feedback is important to the ongoing improvement of Katun products. Thank you.

I. WARRANTY CHOICE

Please check one. See Section 2 on reverse side for additional information.

Technical Evaluation/Replacement Technical Evaluation/Credit Automatic Replacement

II. CUSTOMER INFORMATION

Customer Number: _____ Date Shipped: _____

Company Name: _____ Delivery Date: _____

Address: _____

City: _____ State/Province: _____

Country: _____ Postal Code: _____

Your Name: _____ Title: _____

III. PRODUCT INFORMATION

Katun PN	Quantity	Description	Serial/Lot Number
1) _____	_____	_____	_____
2) _____	_____	_____	_____
3) _____	_____	_____	_____
4) _____	_____	_____	_____
5) _____	_____	_____	_____

IV. DETAILED REASON(S) FOR CLAIM

Provide specific information for each product claimed, explaining the reason for claim in as much detail as possible. Include machine models, machine log information, and copy/print counts. **See Section 3 on reverse side for additional specific requirements for photoreceptors.**

- 1) _____
- 2) _____
- 3) _____
- 4) _____
- 5) _____

FOR KATUN USE ONLY

Product Warranty Claim No.: _____ Pieces: _____
Received By: _____ Date: _____

Central/Eastern Europe

Telephone: 31(0)183-696969

Fax: 31(0)183-629055

E-mail: order@edc.katun.com

PLEASE READ AND COMPLY WITH ALL THESE REQUIREMENTS TO EXPEDITE THE PROCESSING OF YOUR CLAIM.

1. General Instructions

A completed copy of this form must accompany all product warranty claims. Please indicate date of product delivery for determination of warranty coverage time period. *Your feedback is important to the ongoing improvement of Katun products. Please complete all sections on the reverse side.*

2. Distributor Choice Warranty Claim Options

Please indicate your choice of Technical Evaluation/Replacement, Technical Evaluation/Credit, or Automatic Replacement. **NOTE:** Automatic Replacement claims must be filed within 90 days of product delivery date, and must not exceed US\$500/€ 550.

If no choice is indicated:

- (a) If product is included with this form, this claim will be treated as Technical Evaluation/Replacement.
- (b) If no product is included with this form, and the claim is less than US\$500/€ 550, this claim will be treated as Automatic Replacement.
- (c) If no product is included with this form, and the claim is more than US\$500/€ 550, the claim is invalid.

3. Specific Requirements

If damage (for example, a chip or scratch on a photoreceptor) is noted "out-of-box," DO NOT INSTALL THE PRODUCT. No copy/print samples are required. Installing a product with out-of-box damage could void the warranty.

Include applicable copy/print samples with all claims. If a photoreceptor is suspected to be defective after machine installation, please attach to this form the copy/print samples indicated below. This will allow a thorough evaluation of the claim. Ensure that neither the form nor copy/print samples will contact the photoreceptor surface during shipment.

FOR PHOTORECEPTORS USED IN COPIERS, include:

- (a) Three "sky shot" (open platen; black) copies;
- (b) Three white copies; and
- (c) Three copies of a test pattern.

NOTE: If the defect is not visible on the copies indicated above, please attach three copies which clearly show the defect.

FOR PHOTORECEPTORS USED IN PRINTERS AND PLAIN PAPER FACSIMILES, include three prints which clearly show the defect.

IMPORTANT: The Katun product warranty does not cover damage by operator, technician, or machine (including rotational scratches, gouges, scuff marks, or line scratches).

4. Shipping Instructions

ALL PRODUCT RETURNS MUST BE PROPERLY PACKAGED. This includes packaging in the correct individual product box and in a second container with adequate protective packaging material. This is required by all carriers.

NOTE: Products damaged in transit to Katun due to inadequate packaging cannot be covered by the Katun product warranty, and will be returned.

Ship Technical Evaluation claims, freight prepaid, to the address specifically indicated for this purpose in the "General Information" section of the Katun On-Line Catalogue and current printed catalogues. Katun cannot accept responsibility for product warranty claims sent to any other address. **Send Automatic Replacement Claims to your Katun Customer Service Representative.**

HÄNDLER-GARANTIEFORMULAR

Das Formular bitte in Druckschrift ausfüllen. Um eine umgehende Bearbeitung Ihrer Reklamation zu ermöglichen, tragen Sie bitte alle Angaben ein.

Ihr Feedback trägt zur weiteren Verbesserung von Katun-Produkten bei. Vielen Dank.

I. REGULIERUNGSWUNSCH

Bitte nur einen ankreuzen. Weitere Informationen finden Sie in Abschnitt 2 auf der Rückseite.

Technische Bewertung/Ersatz Technische Bewertung/Gutschrift Ersatz ohne Bewertung

II. KUNDENINFORMATIONEN

Kunden-Nr.: _____ Versanddatum: _____

Firmenname: _____ Lieferdatum: _____

Straße: _____

Postleitzahl: _____ Ort: _____

Land: _____

Ihr Name: _____ Titel/Funktion: _____

III. PRODUKTINFORMATIONEN

Katun-Artikel-Nr.	Menge	Bezeichnung	Serien-/Lotnummer
1) _____	_____	_____	_____
2) _____	_____	_____	_____
3) _____	_____	_____	_____
4) _____	_____	_____	_____
5) _____	_____	_____	_____

IV. AUS WELCHEM GRUND REKLAMIEREN SIE DIE WARE?

Machen Sie bitte zu jedem reklamierten Artikel so ausführliche und genaue Angaben wie möglich. Des weiteren benötigen wir Angaben zum Gerätemodell, eine Kopie des Bordbuches sowie Informationen bezüglich der Anzahl der erstellten Kopien/Ausdrucke des Produktes. **Bitte beachten Sie Punkt 3 auf der Rückseite mit wichtigen Informationen zur Reklamation von Fotorezeptoren.**

1) _____

2) _____

3) _____

4) _____

5) _____

NUR FÜR DEN INTERNEN GEBRAUCH

Reklamations-Nr.: _____ Stückzahl: _____

Entgegengenommen von: _____ Eingangsdatum: _____

Central/Eastern Europe

Telephone: 31(0)183-696969

Fax: 31(0)183-629055

E-mail: order@edc.katun.com

BITTE BEACHTEN SIE FOLGENDE HINWEISE, UM DIE BEARBEITUNG IHRER REKLAMATION ZU BESCHLEUNIGEN.

1. Allgemeine Hinweise

Verwenden Sie diesen Mängelbericht bei allen Reklamationen. Geben Sie zur Bestimmung der Garantiefrist bitte das Lieferdatum des Produktes an. *Ihr Feedback trägt zur weiteren Verbesserung von Katun-Produkten bei. Bitte tragen Sie alle Angaben auf der Rückseite vollständig ein.*

2. Händler-Garantieoption

Geben Sie bitte Ihren Regulierungswunsch an (Technische Bewertung/Ersatz, Technische Bewertung/Gutschrift oder Ersatz ohne Bewertung.) **BITTE BEACHTEN:** Reklamationen ohne Bewertung müssen innerhalb von 90 Tagen nach dem Lieferdatum des Produktes geltend gemacht werden und dürfen einen Wert von USD 500/Euro 550 nicht überschreiten.

Wenn keine Wahl getroffen wurde:

- (a) Wenn diesem Formular das Produkt beigelegt wurde, wird diese Reklamation als Technische Bewertung/Ersatz bearbeitet.
- (b) Wenn diesem Formular kein Produkt beigelegt wurde und der Wert der Reklamation weniger als USD 500/ Euro 550 beträgt, wird diese Reklamation als Ersatz ohne Bewertung bearbeitet.
- (c) Wenn diesem Formular kein Produkt beigelegt wurde und der Wert der Reklamation mehr als USD 500/ Euro 550 beträgt, besteht kein Anspruch auf Reklamation.

3. Spezielle Anforderungen

Wenn Schäden (z.B. Splitter oder Kratzer an einem Fotorezeptor) bereits „beim Auspacken“ festgestellt werden, dann **INSTALLIEREN SIE DAS PRODUKT NICHT.** Testkopien sind nicht erforderlich. Die Installation eines Produktes mit bereits bestehendem Schaden könnte zum Erlöschen Ihrer Garantieansprüche führen.

Fügen Sie allen Reklamationen entsprechende Testkopien bei. Wenn ein Fotorezeptor nach der Installation einen Defekt aufzuweisen scheint, legen Sie diesem Formular bitte die nachstehend beschriebenen Testkopien bei, um eine genaue Beurteilung der Mängel zu ermöglichen. Das Formular sowie die Testkopien dürfen bei der Rücksendung auf keinen Fall mit der Oberfläche des Fotorezeptors in Berührung kommen.

FÜR FOTOREZEPTOREN, DIE IN KOPIERERN BENUTZT WURDEN, folgende Testkopien beilegen:

- (a) 3 schwarze Kopien (bei offener Vorlagenglas-Abdeckung),
- (b) 3 weiße Kopien und
- (c) 3 Testkopien (vom Testbogen).

BITTE BEACHTEN: Ist der Defekt auf diesen Mustern nicht sichtbar, legen Sie bitte 3 Kopien bei, auf denen er deutlich zu erkennen ist.

FÜR FOTOREZEPTOREN, DIE IN DRUCKERN UND NORMALPAPIER-FAXGERÄTEN BENUTZT WURDEN, legen Sie bitte 3 Kopien bei, auf denen der Defekt deutlich zu erkennen ist.

WICHTIG: Schäden, die durch falsche Bedienung des Endanwenders, durch den Techniker oder das Gerät verursacht wurden (d. h. umlaufende Kratzer, Streifen, Abrieb oder querlaufende Kratzer), sind von der Katun Qualitätsgarantie ausgeschlossen.

4. Versandrichtlinien

ALLE TEILE, DIE AN UNS ZURÜCKGESANDT WERDEN, MÜSSEN SACHGEMÄSS VERPACKT SEIN, d. h. in dem entsprechenden Einzelkarton und einem zweiten Karton mit entsprechendem Verpackungsmaterial. Dies betrifft jeglichen Transportweg!

BITTE BEACHTEN: Teile, die nicht sachgemäß verpackt werden und uns aus diesem Grunde defekt erreichen, sind von der Katun-Qualitätsgarantie ausgeschlossen und werden nicht angenommen.

Schicken Sie Ihre Reklamation zur technischen Bewertung (frachtfrei) an die für diese Zwecke im Katun-Online-Katalog und dem gültigen regulären Katalog unter den „allgemeinen Hinweisen“ angegebene Adresse. Katun übernimmt keinerlei Verantwortung für Reklamationen, die an eine andere Adresse als die oben genannte geschickt werden. **Schicken Sie Reklamation zum Ersatz ohne Bewertung an Ihren Katun-Ansprechpartner.**

