

Katun Products for use in

Ricoh

Table of Contents

| | <i>Page</i> |
|---|-------------|
| Copy Machine Equivalency List | i |
| Descriptions of Katun Product Brands and Technologies | ix |
| Beschreibungen der Produktmarken und Technologien von Katun | xi |
| Personalized Product Agreement | xiii |
| Vereinbarung Über Bestellung Von Produkten Mit Ihrem Firmenetikett | xv |
| Bearings/Bushings | 1 |
| Belts | 5 |
| Blades/Brushes | 6 |
| Corona/Charge/Transfer | 9 |
| Developers | 12 |
| Feed/Delivery | 14 |
| Filters | 22 |
| Fuser Cleaning | 23 |
| Fuser Oil | 25 |
| Gears | 26 |
| Kits | 27 |
| Lamps | 32 |
| Memory Upgrades | 33 |
| Miscellaneous | 34 |
| Photoreceptors | 35 |
| Picker Fingers | 39 |
| Rollers, Fuser/Heat | 41 |
| Rollers, Pressure | 45 |
| Seals | 47 |
| Thermal Control Devices | 48 |
| Toners/Toner Cartridges | 49 |
| General Information | I |
| Allgemeine Hinweise | III |
| Distributor Choice Warranty Claim Form | V |
| HÄNDLER-GARANTIEFORMULAR | VII |

Copy Machine Equivalency List

Central/Eastern Europe
 Telephone: 31(0)183-696969
 Fax: 31(0)183-629055
 E-mail: order@edc.katun.com

| Ricoh | Danka Infotec | Gestetner | Nashuatec | Rex Rotary |
|-------------------|---------------|------------|------------|----------------|
| AFICIO 120 | | 1202 | D 1205 | 1208 |
| AFICIO 150 | 4150 MF | 3215 S | D 415 S | 2815 S |
| AFICIO 180 | 4180 MF | 3218 | D 418 | 2818 |
| AFICIO 200 | 4201 MF | 3220 | D 420 | 2820 |
| AFICIO 220 | 4220 MF | 3222 | D 422 | 2822 |
| AFICIO 250 | 4251 MF | 3225 | D 425 | 2825 |
| AFICIO 270 | 4270 MF | 3227 | D 427 | 2827 |
| AFICIO 340 | 4351 MF | 3235 S | D 435 s | 2835 s |
| AFICIO 350 | 4352 MF | 3235 | D 435 | 2835 |
| AFICIO 400 | 5401 DZ | 2640 e | D 3640 | 8240 e |
| AFICIO 401 | 5402 MF | 3240 | D 440 | 2840 |
| AFICIO 450 | 4451 MF | 3245 | D 445 | 2845 |
| AFICIO 470 W | | A 070 | | A 070 |
| AFICIO 500 | | 2850 e | D 4850 | 8250 E |
| AFICIO 550 | 4550 MF | 3255 | D 455 | 2855 8255 E |
| AFICIO 551 | 4551 MF | 3355 | D 555 | 2955 |
| AFICIO 650 | 4651 MF | 3265 | D 465 | 2865 |
| AFICIO 700 | 4700 MF | 3270 | D 570 | 2870 |
| | | 3370 | | |
| AFICIO 850 | 4850 MF | 3285 | D 485 | 2885 |
| AFICIO 1013 | | 1302 | D 1305 | 1308 |
| AFICIO 1013 F | | 1302 f | D 1305 F | 1308 f |
| AFICIO 1015 | | 1502 | 1505 | 1508 |
| AFICIO 1018 | | 1802 | 1805 | 1808 |
| AFICIO 1018 D | | 1802 d | 1805 D | 1808 D |
| AFICIO 1022 | | 2212 | D 2205 | 2238 |
| AFICIO 1027 | | 2712 | 2705 | 2738 |
| | | | D 2705 | |
| AFICIO 1032 | | 3212 | D 3205 | 3238 |
| AFICIO 1035 | | 3502 | 3525 | 3508 |
| | | | D 3525 | |
| AFICIO 1045 | | 4502 | 4525 | 4508 |
| AFICIO 1050 | 4105 MF | 32105 | D 4105 | 28105 |
| AFICIO 1055 | | 5502 | D 5505 | |
| AFICIO 1060 | | 6002 | D 6005 | 6008 |
| AFICIO 1075 | | 7502 | D 7505 | 7508 |
| AFICIO 1085 | | 8502 | D 8505 | 8508 |
| AFICIO 1105 | | 10502 | D 10505 | 10508 |
| AFICIO 1224 C | | DSc 224 | DSc 224 | |
| | | DSC 224 SP | | |
| AFICIO 1224 C S/P | | DSc 224 | DSc 224 | |
| | | DSC 224 SP | | |
| AFICIO 1232 C | | DSc 232 | DSc 232 | |
| | | DSC 232 SP | | |
| | | DSC 532 | | |
| AFICIO 1232 C S/P | | DSc 232 | DSc 232 | |
| | | DSC 232 SP | | |
| | | DSC 532 | | |
| AFICIO 1515 | | | DSM 415 | |
| AFICIO 1515 F | | | DSM 415 F | |
| AFICIO 1515 MF | | | DSM 415 PF | |
| AFICIO 1515 PS | | | DSM 415 P | |

Copy Machine Equivalency List

| Ricoh | Danka Infotec | Gestetner | Nashuatec | Rex Rotary |
|--------------------|---------------|-----------|-----------|------------|
| AFICIO 2015 | | DSM 615 | DSM 615 | |
| AFICIO 2018 | | DSM 618 | DSM 618 | |
| AFICIO 2018 D | | DSM 618 D | DSM 618 D | |
| AFICIO 2022 | | DSM 622 | | |
| AFICIO 2027 | | DSM 627 | | |
| AFICIO 2032 | | | DSM 632 | |
| AFICIO 2035 | | 3532 | | |
| | | 4235 G | | |
| | | DSM 632 | | |
| AFICIO 2035 G | | 3532 | | |
| | | 4235 G | | |
| | | DSM 632 | | |
| AFICIO 2045 | | 4245 G | | |
| | | 4532 | | |
| AFICIO 2045 G | | 4245 G | | |
| | | 4532 | | |
| AFICIO 2090 | | 9002 | | |
| AFICIO 2105 | | 10512 | | |
| AFICIO AP 3800 CMF | | DSc 38 + | DSc 38 + | DSc 38 + |
| AFICIO COLOR 2003 | 7212 Z | 2703 | C 503 | CC 8403 |
| AFICIO COLOR 2103 | 7212 DZ | 2703 d | C 503 D | CC 8403 D |
| AFICIO COLOR 2203 | 7212 EZ | 2703 de | C 503 De | CC 8403 DE |
| AFICIO COLOR 3006 | 7216 Z | CS 206 | CS 506 | CS 806 |
| AFICIO COLOR 3506 | | CS 225 | CS 525 | CS 825 |
| AFICIO COLOR 4006 | 7286 DZ | CS 206 D | CS 506 d | CS 806 d |
| AFICIO COLOR 4106 | 7286 EZ | CS 206 de | CS 506 de | CS 806 DE |
| AFICIO COLOR 4506 | | CS 231 | CS 531 | CS 831 |
| AFICIO COLOR 5106 | 7316 | 2606 | C 606 | CC 8606 |
| AFICIO COLOR 5206 | 7316 E | 2606 e | C 606 E | CC 8606 E |
| AFICIO COLOR 6010 | 7410 | CS 210 | CS 510 | CS 810 |
| AFICIO COLOR 6110 | 7410 E | CS 210 e | CS 510 E | CS 810 e |
| AFICIO COLOR 6513 | | CS 213 d | CS 513 d | CS 813 D |
| DS 320 | 5020 | | D 209 | |
| DS 5330 | | 3131 | D 431 | |
| FT 1008 | 5081 | 2808 | 3708 S | 8708 |
| FT 1208 | 5081 Z | 2808 z | 3708 | 8708 Z |
| FT 2012 | 5121 | 2812 | 3612 S | 8612 |
| FT 2050 | 9016 | | 5115 | |
| FT 2070 | 9016 Z | | 5115 RE | |
| FT 2212 | 5121 Z | 2812 z | 3612 | 8612 Z |
| FT 2260 | 9115 Z | | 8115 | |
| FT 3013 | 9313 | 2613 | 3413 S | 8613 |
| FT 3020 | 9015 | | 4100 | |
| FT 3050 | 9015 RE | | 4110 | |
| FT 3060 | 9015 Z | | 4115 | |
| FT 3113 | 9213 | 2513 | 3213 S | 8513 |
| FT 3213 | 9313 Z | 2613 z | 3413 | 8613 Z |
| FT 3313 | 9213 Z | 2513 Z | 3213 | 8513 Z |
| FT 3320 | 9014 | | 7112 | |
| FT 3413 | | 2513 LZ | 3213 L | |
| FT 3513 | 5131 | 2713 | 3713 S | 8713 |
| FT 3613 | 3613 | 2913 | 3913 S | 8913 |
| FT 3713 | 5131 Z | 2713 z | 3713 | 8713 Z |

Copy Machine Equivalency List

Central/Eastern Europe
 Telephone: 31(0)183-696969
 Fax: 31(0)183-629055
 E-mail: order@edc.katun.com

| Ricoh | Danka Infotec | Gestetner | Nashuatec | Rex Rotary |
|---------|---------------|-----------|-----------|------------|
| FT 3813 | 5132 Z | 2913 Z | 3913 | 8913 Z |
| FT 4015 | 5151 Z | 2715 z | 3715 | 8715 z |
| FT 4018 | 5181 Z | 2718 z | 3718 | 8718 Z |
| FT 4022 | 5221 Z | 2822 | 3522 | 8622 Z |
| FT 4027 | 5271 Z | 2627 | 3527 | 8627 Z |
| FT 4030 | 9018 | | 4300 | |
| FT 4060 | 9020 | | 4310 | |
| FT 4065 | 9020 Z | | 5120 | |
| FT 4085 | 9025 Z | | 4325 z | |
| FT 4127 | 5271 ZU | 2627 t | 3527 t | 8627 LZ |
| FT 4215 | 9315 | 2615 | 3415 | 8615 |
| FT 4220 | 9320 | 2620 | 3320 | 8520 |
| FT 4222 | 9322 | 2622 | 3322 | 8522 |
| FT 4227 | | 2527 Z | 3227 | 8527 |
| FT 4415 | 9215 | 2515 Z | 3115 | 8515 Z |
| FT 4418 | 9118 Z | 2518 Z | 3018 | 8518 Z |
| FT 4421 | 9122 Z | 2520 ZD | 3120 | |
| | | 2522 | 3222 | |
| FT 4422 | 9222 Z | 2622 s | 3322 S | 8522 S |
| FT 4427 | 9227 Z | 2527 LZ | 3227 L | |
| FT 4430 | 9120 Z | | | |
| FT 4460 | 9021 Z | | 7120 | |
| FT 4470 | 9125 Z | 2525 Z | 7125 S | |
| FT 4480 | 9026 Z | | 7125 | |
| FT 4490 | 9126 Z | | 7125 II | |
| FT 4522 | 5221 DZ | 2822 td | 3522 td | 8622 DZ |
| FT 4527 | 5271 DZ | 2627 td | 3527 td | 8627 DZ |
| FT 4615 | 5152 Z | 2715 z+ | 3715 + | 8715 Z+ |
| FT 4618 | 5182 Z | 2718 z+ | 3718 + | 8718 Z+ |
| FT 4622 | 5222 Z | 2722 z | 3722 | 8722 z |
| FT 4727 | 9227 DZ | 2527 ZD | 3227 LD | 8527 D |
| FT 4822 | 5222 DZ | 2722 ztd | 3722 td | 8722 ztd |
| FT 5000 | 9032 | | 5131 | |
| FT 5010 | 9032 Z | | 5130 | |
| FT 5035 | 5351 Z | 2635 | 3535 | 8635 Z |
| FT 5050 | 9035 Z | | 4510 z | |
| FT 5070 | 9035 DZ | | 4550 z | |
| FT 5135 | 5351 ZL | 2635 t | 3535 t | 8635 LZ |
| FT 5233 | 9233 Z | 2533 z | 3133 | 8533 |
| FT 5433 | | 2533 lz | 3133 L | |
| FT 5520 | 9034 Z | | 7130 | |
| | 9134 Z | | | |
| FT 5535 | 5351 DZ | 2635 td | 3535 td | 8635 DZ |
| FT 5540 | | | 3035 | |
| | | | 3135 D | |
| FT 5550 | 9143 Z | 2543 z | 3943 | 8543 |
| FT 5560 | 9040 Z | | 7140 | |
| FT 5570 | 9143 DZ | 2543 zd | 3943 d | 8543 D |
| FT 5580 | 9048 Z | | 7150 | |
| | 9150 Z | | | |
| FT 5590 | 9048 DZ | | 7150 D | |
| | 9150 DZ | | | |
| FT 5632 | 5321 Z | 2632 | 3632 | 8632 |



Copy Machine Equivalency List

| Ricoh | Danka Infotec | Gestetner | Nashuatec | Rex Rotary |
|---------|---------------|-----------|-----------|------------|
| FT 5640 | 5403 Z | 2740 z | 3640 | 8640 |
| | | | 3740 | 8740 Z |
| FT 5732 | 5321 ZL | 2732 z | 3732 | 8732 Z |
| FT 5733 | 9233 DZ | 2533 lzd | 3133 LD | 8533 D |
| FT 5740 | 5403 ZT | 2740 zt | 3740 t | 8740 ZT |
| FT 5832 | 5321 DZ | 2732 ztd | 3732 td | 8732 ZTD |
| FT 5840 | 5403 DZ | 2740 ztd | 3740 td | 8740 ZTD |
| FT 6080 | 9046 RED | | 4790 MK1 | |
| FT 6085 | 9050 RED | | 4790 MK2 | |
| FT 6200 | 9030 | | | |
| FT 6620 | 9052 DZ | | 7150 C | |
| FT 6645 | 9345 DZ | 2545 d | 4345 | 8545 DZ |
| FT 6655 | 9355 DZ | 2555 d | 4355 | 8555 DZ |
| FT 6665 | 9365 DZ | 2565 d | 4365 | 8565 DZ |
| FT 6750 | 9153 DZ | 2553 zd | 4050 | 8553 D |
| FT 7060 | 9060 DZ | | 6160 | |
| FT 7650 | 5501 DZ | 2651 | 4651 | 8651 |
| FT 7660 | 5601 DZ | 2660 | 4660 | 8660 |
| | | 2760 | | |
| FT 7670 | 5701 DZ | 2670 | 4670 | 8670 |
| | | 2770 | | |
| FT 7770 | 9165 DZ | | 4965 | |
| FT 7870 | 9172 DZ | 2572 zdf | 4172 | |
| FT 7950 | 5502 DZ | 2851 | 4851 | 8851 |
| FT 7960 | 5602 DZ | 2860 | 4860 | 8860 |
| FT 7970 | 5702 DZ | 2870 | 4870 | 8870 |
| FT 8780 | | 2580 zdf | 4280 | 8580 DZF |
| FT 8880 | 9280 | 2580 rdz | 4280 rdh | 8580 DZH |
| FT 8980 | 5801 RDH | 2680 rdh | 4580 rdh | 8680 RDH |
| FT 8982 | 5821 DZ | 2682 d | 4582 | 8682 D |
| FT 9101 | 9101 | 25101 | 53101 | 85101 |
| FT 9105 | | 27105 | 37105 | |
| FW 740 | | 26A0 | 55A0 | 83A0 |
| FW 750 | | 281A0 | 481A0 | 881A0 |
| FW 760 | | 282A0 | 482A0 | 882A0 |
| FW 770 | | A 040 | | A 040 |
| FW 780 | | A 041 | | A 041 |
| FW 830 | | 25A0 | 5307 | 8007 |
| FW 870 | | 27A0 | 57A0 | 87A0 |
| M 5 | 9208 OLD | | 5108 | |
| M 10 | 9012 | | 3900 | |
| M 50 | 9208 | 2508 | 2208 | 8508 (OLD) |
| M 60 | 9407 | 2607 | 2407 | 8607 |
| M 100 | 9016 S | | 6115 | |
| NC 100 | 7125 | 2730 | C 240 | |
| NC 305 | 7130 | 2735 | C 302 | CC 8330 |
| NC 5006 | 7306 | 2706 | C 406 | CC 8406 |
| NC 8015 | 7150 | 2780 | C 315 | |
| AD- 100 | DU- 9032 Z | | DU- 513 | |
| AD- 110 | DU- 9034 | AD- 110 | DU- 7130 | AD- 110 |
| AD- 120 | DU- 9118 | AD- 120 | DU- 3018 | AD- 120 |
| AD- 130 | DU- 9320 | CDX- 20 | CDX- 20 | |
| AD- 400 | DU II- 40 | | DU- 140 | |

Copy Machine Equivalency List

Central/Eastern Europe
 Telephone: 31(0)183-696969
 Fax: 31(0)183-629055
 E-mail: order@edc.katun.com

| Ricoh | Danka Infotec | Gestetner | Nashuatec | Rex Rotary |
|------------------|------------------|------------------|------------------|------------------|
| AD- 500 | DUPLEX I- 21 | | DU- 120 | |
| AD- 600 | DU- 5020 | | DU- 4050 | |
| ARDF | ARDF- 9060 DZ | ARDF | ARDF- 6160 | |
| CONTROLLER- 850 | | CONTROLLER- 850 | CONTROLLER- 850 | CONTROLLER- 850 |
| CONTROLLER- 1013 | | CONTROLLER- 1013 | CONTROLLER- 1013 | CONTROLLER- 1013 |
| CONTROLLER- 1018 | | CONTROLLER- 1018 | CONTROLLER- 1018 | CONTROLLER- 1018 |
| CS- 110 | S- 102 | SR- 3018 | SR- 3018 | CS- 110 |
| CS- 120 | S- 101 | S- 313 | S- 313 | S- 313 |
| CS- 130 | CS- 130 | CS- 130 | CS- 130 | CS- 130 |
| CS- 160 | | CS- 160 | CS- 160 | CS- 160 |
| CS- 210 | S- 121 | DIG S- 1 | DIG S- 1 | |
| CS- 220 | CS- 220 | CS- 220 | CS- 220 | CS- 220 |
| CS- 1020 | SORTER- 9018 | | S- 430 | |
| CS- 1030 | SORTER- 9025 Z | | S- 432 | |
| CS- 1040 | SORTER- 9016 | | S- 511 | |
| CS- 1070 | SORTER- 5020 | | SORTER- D 209 | |
| CS- 1510 | SORTER- 9035 DZ | | S- 455 | |
| CS- 1530 | SORTER- 9048 DZ | CS- 1530 | SORTER- 7150 D | CS- 1530 |
| CS- 2030 | SORTER- 9046 RED | | S- 479 | |
| CS- 2060 | SORTER- 9060 | | S- 616 | |
| CS- 2065 | SORTER- 9165 | CS- 2065 | SORTER- 4172 | |
| CS- 2080 | S- 202 | CS- 2080 | MS SORTER- 20 | CS- 2080 |
| | SORTER- 40/48 | | | |
| DF- 10 | SADF- 9020 | | F- 435 | |
| DF- 11 | SADF- 9020 Z | | F- 433 | |
| DF- 31 | DF- 9050 RED | | F- 480 | |
| DF- 32 | ADF- 9035 DZ | | F- 456 | |
| DF- 34 | S/ADF- 9020 Z | | F- 513 | |
| DF- 36 | ADF- 9016 | | F- 511 | |
| DF- 40 | ADF- 1 | F- 321 | F- 321 | F- 321 |
| DF- 43 | DF- 43 | DF- 43 | DF- 43 | DF- 43 |
| DF- 51 | ARDF- III | DF- 51 | RF- II | DF- 51 |
| DF- 52 | ARDF I- 21 | | RF I- 120 | |
| DF- 53 | ARDF- 5020 | | ADF- D 209 | |
| DF- 54 | ARDF- IV | F- 811 | F- 811 | F- 811 |
| DF- 56 | ARDF- V/VI | DF- 56 | RF- 3 | DF- 56 |
| DF- 57 | ARDF- IV/II | RF- 3020 | RF- 3020 | DF- 57 |
| DF- 60 | ARDF- VII | CRF- 55 | CRF- 55 | CRF- 55 |
| DF- 62 | | DF- 62 | | |
| DF- 64 | DF- 64 | DF- 64 | DF- 64 | DF- 64 |
| DF- 65 | DF- 65 | DF- 65 | DF- 65 | DF- 65 |
| DF- 67 | DF- 67 | DF- 67 | DF- 67 | DF- 67 |
| DF- 68 | | DF- 68 | DF- 68 | DF- 68 |
| DF- 69 | | DF- 69 | DF- 69 | DF- 69 |
| DF- 70 | | DF- 70 | DF- 70 | DF- 70 |
| DF- 71 | | DF- 71 | DF- 71 | DF- 71 |
| DF- 72 | | DF- 72 | DF- 72 | DF- 72 |
| DF- 38/39 | ADF- 9026 Z | DF- 38/39 | F- 140 | |
| DH- 200 | DH- II | DH- 4050 | DH- 4050 | DH- 200 |
| DH- 400 | DH- III | CRDH- 55 | CRDH- 55 | CRDH- 55 |
| DH- 500 | | DH- 500 | | |
| E- 310 | | E- 310 | E- 310 | E- 310 |
| E- 700 | | E- 700 | E- 700 | E- 700 |

Copy Machine Equivalency List

| Ricoh | Danka Infotec | Gestetner | Nashuatec | Rex Rotary |
|-------|---------------|-----------|-----------|------------|
|-------|---------------|-----------|-----------|------------|

| | | | | |
|--------------------|-------------------|--------------------|--------------------|--------------------|
| E- 710 | | E- 710 | E- 710 | E- 710 |
| EB- 70 | | EB- 70 | EB- 70 | EB- 70 |
| EB- 105 | | EB- 105 | EB- 105 | EB- 105 |
| FIERY- 150 i | FIERY- 150 i | FIERY- 150 i | FIERY- 150 i | |
| FIERY- 200 i | FIERY- 200 i | FIERY- 200 i | FIERY- 200 i | FIERY- 200 i |
| FIERY- E 300 | FIERY-E 300 | FIERY- E 300 | FIERY- E 300 | FIERY- E 300 |
| FIERY- E 650 | FIERY-E 650 | FIERY- E 650 | FIERY- E 650 | FIERY- E 650 |
| FIERY- XJ 80 e | FIERY-XJ 80 e | FIERY- XJ 80 e | FIERY- XJ 80 e | FIERY- XJ 80 e |
| FIERY- XJ 170 PLUS | FIERY-XJ 170 PLUS | FIERY- XJ 170 PLUS | FIERY- XJ 170 PLUS | FIERY- XJ 170 PLUS |
| FIERY- XJ 250 PLUS | FIERY-XJ 250 PLUS | FIERY- XJ 250 PLUS | FIERY- XJ 250 PLUS | FIERY- XJ 250 PLUS |
| FIERY- XJ 300 PLUS | FIERY-XJ 325 PLUS | FIERY- XJ 325 PLUS | FIERY- XJ 325 PLUS | FIERY- XJ 325 PLUS |
| FIERY- XJ 325 PLUS | FIERY-XJ 325 PLUS | FIERY- XJ 325 PLUS | FIERY- XJ 325 PLUS | FIERY- XJ 325 PLUS |
| FIERY- XJ BP 100 | FIERY-XJ BP 100 | FIERY- XJ BP 100 | FIERY- XJ BP 100 | FIERY- XJ BP 100 |
| FIERY- ZX 3200 | FIERY-ZX 3200 | FIERY- ZX 3200 | FIERY- ZX 3200 | FIERY- ZX 3200 |
| FIERY- ZX 3300 | FIERY-ZX 3300 | FIERY- ZX 3300 | FIERY- ZX 3300 | FIERY- ZX 3300 |
| FIERY-XJ 300 PLUS | FIERY-XJ 300 PLUS | FIERY- XJ 300 PLUS | FIERY- XJ 300 PLUS | FIERY- XJ 300 PLUS |
| PS- 110 | PAPER BANK- 5020 | | PAPER BANK- D 209 | |
| PS- 140 | CB- 33/1 | CB- 313 X1 | CB- 313 X1 | CB- 313 X1 |
| PS- 150 | CT- 2 | EU- C 302 | EU- C 302 | EU- C 302 |
| PS- 210 | CB- 1/21 | | CB- 140 | |
| PS- 220 | CB- 4 | CB- 150 | CB- 150 | CB- 150 |
| | CB- 3/48 | | | |
| PS- 250 | CB- 33/3 | CB- 313 X3 | CB- 313 X3 | CB- 313 X3 |
| PS- 270 | PS- 270 | PS- 270 | PS- 270 | PS- 270 |
| PS- 280 | PS- 280 | PS- 280 | PS- 280 | PS- 280 |
| PS- 290 | PS- 290 | PS- 290 | PS- 290 | PS- 290 |
| PS- 310 | | DIG LCT- 1 | DIG LCT- 1 | DIG LCT- 1 |
| PS- 320 | | DIG LCT- D | DIG LCT- D | DIG LCT- D |
| PS- 330 | PS- 330 | PS- 330 | PS- 330 | PS- 330 |
| PS- 360 | PS- 360 | PS- 360 | PS- 360 | PS- 360 |
| PS- 380 | | PS- 380 | PS- 380 | PS- 380 |
| PS- 390 | | PS- 390 | PS- 390 | PS- 390 |
| PS- 400 | | PS- 400 | PS- 400 | PS- 400 |
| PS- 410 | | PS- 410 | PS- 410 | PS- 410 |
| PS- 420 | | PS- 420 | PS- 420 | PS- 420 |
| PS- 440 | | PS- 440 | PS- 440 | PS- 440 |
| PS- 450 | | PS- 450 | PS- 450 | PS- 450 |
| PS- 460 | | PS- 460 | PS- 460 | PS- 460 |
| PS- 480 | | PS- 480 | PS- 480 | PS- 480 |
| PS- 490 | | PS- 490 | PS- 490 | PS- 490 |
| PS- 500 | | PS- 500 | PS- 500 | |
| RT- 14 | LCT- 9032 | | T- 51 | |
| RT- 15 | LCT- 5020 | RT- 15 | T- 1 | RT- 15 |
| | LCT- 21/26 | | | |
| RT- 16 | LCT- 35/48 | RT- 16 | T- 45 | RT- 16 |
| RT- 17 | LCT- 3 | TC- 302 | TC- 302 | TC- 302 |
| RT- 21 | LCT- 48 | RT- 21 | T- 150 | RT- 21 |
| RT- 25 | LCT- 9165 DZ | RT- 25 | LCT- 4965 | |
| RT- 30 | LCT- 4 | T- 428 | T- 428 | T- 428 |
| RT- 31 | LCT- 5 | RT- 31 | CLCT- 55 | |
| RT- 32 | | T- 251 | T- 251 | T- 251 |
| RT- 33 | RT- 33 | RT- 33 | RT- 33 | RT- 33 |
| RT- 34 | RT- 34 | RT- 34 | RT- 34 | RT- 34 |

Copy Machine Equivalency List

Central/Eastern Europe
 Telephone: 31(0)183-696969
 Fax: 31(0)183-629055
 E-mail: order@edc.katun.com

| Ricoh | Danka Infotec | Gestetner | Nashuatec | Rex Rotary |
|---------------|----------------------|---------------|---------------|---------------|
| RT- 36 | RT- 36 | RT- 36 | RT- 36 | RT- 36 |
| RT- 42 | | RT- 42 | RT- 42 | RT- 42 |
| RT- 43 | | RT- 43 | RT- 43 | RT- 43 |
| SADF | SADF- 9030 | | SADF- 4200 | |
| SPU- 2 | FP- 7306 | CCFPU- 6 | CCFPU- 6 | CCFPU- 6 |
| SPU- 4 | | SPU- 4 | SPU- 4 | SPU- 4 |
| SR- 85 | | SR- 85 | SR- 85 | SR- 85 |
| SR- 100 | STAPLER- I | SR- 100 | STP- 715 | SR- 100 |
| SR- 200 | STAPLER- II | SR- 200 | SP- 4050 | SR- 200 |
| SR- 300 | FINISHER- 1 | ST- 428 | ST- 428 | ST- 428 |
| SR- 400 | STAPLER- III | CFN- 55 | CFN- 55 | CFN- 55 |
| SR- 500 | | CFN- 101 | CFN- 101 | CFN- 101 |
| SR- 700 | | SR- 700 | SR- 700 | SR- 700 |
| SR- 710 | | SR- 710 | SR- 710 | SR- 710 |
| SR- 720 | SR- 720 | SR- 720 | SR- 720 | SR- 720 |
| SR- 760 | | SR- 760 | SR- 760 | SR- 760 |
| SR- 770 | | SR- 770 | SR- 770 | SR- 770 |
| SR- 790 | | SR- 790 | SR- 790 | SR- 790 |
| SR- 800 | SR- 800 | SR- 800 | SR- 800 | SR- 800 |
| SR- 810 | | SR- 810 | SR- 810 | SR- 810 |
| SR- 820 | | SR- 820 | SR- 820 | SR- 820 |
| SR- 840 | | SR- 840 | SR- 840 | SR- 840 |
| SR- 850 | | SR- 850 | SR- 850 | SR- 850 |
| SR- 860 | | SR- 860 | SR- 860 | SR- 860 |
| SR- 900 | | SR- 900 | | |
| ST- 10 | ST- 10 | ST- 10 | ST- 10 | ST- 10 |
| ST- 20 | SORTER/STAPLER- 9165 | ST- 20 | SR- 4965 | |
| ST- 21 | SS- 202 | ST- 21 | SR- 4050 | ST- 21 |
| ST- 22 | SS- 201 | ST- 22 | SR- 313 | ST- 22 |
| ST- 23 A | | ST- 23 A | SS- 428 A | ST- 23 A |
| ST- 23 B | | ST- 23 B | SS- 428 B | ST- 23 B |
| ST- 24 | SS- 203 | ST- 24 | SR- 3227 | ST- 24 |
| ST- 25 | SS- 204 | ST- 25 | CSS- 55 | ST- 25 |
| ST- 27 A | ST- 27 A | ST- 27 A | ST- 27 A | ST- 27 A |
| ST- 27 B | ST- 27 B | ST- 27 B | ST- 27 B | ST- 27 B |
| ST- 28 | | ST- 28 | | |
| ST- 29 | ST- 29 | ST- 29 | ST- 29 | ST- 29 |
| ST- 30 | ST- 30 | ST- 30 | | ST- 30 |
| ST- 32 | | ST- 32 | ST- 32 | ST- 32 |
| ST- 33 | | ST- 33 | ST- 33 | ST- 33 |
| TP FUSER- 1 | FFU- 7125 | FU- 2730 | FU- C 240 | |
| TR- 85 | | TR- 85 | TR- 85 | TR- 85 |
| TRAY KIT- 850 | | TRAY KIT- 850 | TRAY KIT- 850 | TRAY KIT- 850 |

Descriptions of Katun Product Brands and Technologies

Katun Performance Products

Katun Performance is our complete line of office automation products that combine our highest quality level with consistent, reliable performance and competitive pricing - and provide excellent overall value.

Katun Performance products meet strict quality guidelines and have been 100% tested and approved according to the Katun 360° Certification process, which includes environmental testing, forward and reverse compatibility testing, model application testing, and component compatibility testing. In addition, all Katun Performance products are warranted to be free from functional defects in material and workmanship for one year and come with the highest level of Katun technical support.

To locate Katun Performance products, look for the Katun Performance icon  throughout this catalog.

Access by Katun Products

Access by Katun is a line of selected products that address the unique pricing or product needs of specific markets. Access by Katun products provide market acceptable quality and market competitive pricing. The Access by Katun product line complements the Katun Performance line by providing a value proposition based primarily on specific market needs.

Access by Katun products come with a limited level of product support and a one-year warranty. Although Access by Katun products provide some price advantages, remember that Katun Performance products always provide excellent overall value.

Original Products

Select OEM brand products that Katun offers to meet certain market needs

Fuser Roller Coating Technologies

Minco Manufacturing, Inc., a wholly owned subsidiary of Katun Corporation, is a world-leading manufacturer of fuser rollers for use in plain paper copiers, facsimiles, and printers. The product development relationship between Katun, Minco, and DuPont, the exclusive manufacturer of genuine TEFLON[®] brand coatings, has produced numerous advanced fuser roller coating technologies, including:

DURAPREM™II upper fuser rollers are manufactured with a heat-resistant, nonstick TEFLON[®] brand coating that provides increased surface hardness for extended potential life. A proprietary finishing process produces an exceptionally smooth surface, which contributes to these rollers' excellent fusing performance and toner release in machines using negative-charge toner.

DURACON™II upper fuser rollers are manufactured with a heat-resistant, nonstick TEFLON[®] brand coating that includes patented conductive additives for static dissipation. These rollers provide excellent fusing performance, toner release, and long life, primarily in machines using positive-charge toner.

ALUMANA™ upper fuser rollers are manufactured with extremely hard, tough primer and midcoat layers for maximum resistance to wear and abrasion. The ceramic ALUMANA coating combines a DuPont-patented polymer blend with reinforcing oxides for enhanced durability. These heavy-duty rollers are specifically designed to meet the demands of hostile fuser station environments and higher-speed machines using either positive-charge or negative-charge toner.

TRITON™II upper fuser rollers are manufactured with an advanced TEFLON[®] brand coating that provides improved fusing performance and nonstick characteristics in comparison to conventional fluoropolymer coatings. Unique static-dissipative particulates within the TRITON II coating, together with enhanced manufacturing processes, contribute to these rollers' superior abrasion- resistance and excellent toner release. These rollers provide extended potential life in selected machines using either positive- charge or negative-charge toner.

Central/Eastern Europe

Telephone: 31(0)183-696969

Fax: 31(0)183-629055

E-mail: order@edc.katun.com

TRITON BLUE™ upper fuser rollers deliver excellent performance for machine applications that are tough on fuser rollers. Manufactured with an advanced TEFLON® brand coating that provides improved fusing performance and nonstick characteristics in comparison to conventional fluoropolymer coatings, TRITON BLUE™ fuser rollers combine improved wear resistance with superior abrasion-resistance and excellent toner release.

TUF/SIL™ upper fuser rollers are manufactured with a layer of silicone rubber that effectively regulates heat flow to the toner, plus an outermost layer that consists of a specially blended TEFLON® brand coating providing excellent toner release and abrasion-resistance. This combination ensures reduced toner offsetting and improved, more consistent copy quality under certain demanding machine usage conditions. These rollers provide a high-performance, cost-effective solution for selected machines required to consistently produce the best possible copy quality.

MICROSLEEVE™ lower pressure rollers, with nonstick PFA sleeves 50, 70, or 100 microns in thickness, provide excellent wear-resistance for improved copy quality over an extended life. A-Series MICROSLEEVE™ lower pressure rollers are designed specifically for machines utilizing lower fuser cleaning rollers. Their unique surface texture reduces toner buildup and improves cleaning efficiency within the fuser station.

All Katun fuser rollers are designed specifically for their intended applications and manufactured to exacting quality standards, ensuring their excellent performance and long life.

Fuser Cleaning Roller Coating Technologies

Katun has introduced unique fuser cleaning roller technologies for machines requiring efficient removal and absorption of excess toner and contaminants, as well as continuous silicone oil lubrication of critical fuser station parts. For many machines, the ideal parts combination for achieving optimum copy quality and maximum parts life includes a specially designed Katun fuser cleaning roller.

FIBRA™ fuser cleaning rollers incorporate a uniform network of special fibers that aggressively remove excess toner and contaminants from the contacted surface. By efficiently depositing toner and contaminants beneath its outermost surface, the unique FIBRA network also helps maintain a continuous lubricative flow of silicone oil from the roller's internal tank to critical fuser station parts.

FIBRA™ II fuser cleaning rollers incorporate a unique configuration of highly heat-resistant fibers to greatly enhance cleaning performance, especially in hostile fuser station environments. Efficient absorption of excess toner and contaminants, together with continuous silicone oil lubrication of critical fuser station parts, effectively reduce parts and service expenses associated with the fuser station.

TEFLON® is a registered trademark of E.I. DuPont de Nemours and Company used under license by Katun Corporation.

Personalized Product Program

Katun offers an extremely cost-effective way for office equipment dealers/distributors to ensure repeat business and strengthen relations with customers. The **Personalized Product program** enables dealers/distributors to provide high-quality Katun Performance imaging supplies (toner, fax and printer toner cartridges, digital duplicator inks and masters and thermal transfer ribbons) with their business name and /or logo, plus contact information, so end-users always know whom to call to reorder. For a one-time, nominal set-up fee, Katun designs and produces full-color labels to customer specifications and applies them to packaging at no extra charge. Only end-user-replaceable Katun Performance products are eligible under the program. Enrollment is simple and easy. Just complete the agreement form and submit it to your Katun sales representative or visit the Personalized Products page for more program and enrollment information.

Beschreibungen der Produktmarken und Technologien von Katun

Katun Performance-Produkte

Katun Performance ist unsere umfangreiche Produktreihe von Büromaschinenprodukten, die sich durch hohe Qualität sowie durch beständige, zuverlässige Leistung und attraktive Preise auszeichnen. Mit diesen Produkten soll der Nutzwert für den Kunden maximiert werden.

Katun Performance -Produkte erfüllen strenge Qualitätsstandards und wurden alle im Rahmen des 360°-Zertifizierungsverfahrens von Katun getestet und freigegeben. Die Produkte durchlaufen dabei Prüfungen der Umweltverträglichkeit, der Kompatibilität, der Modellanwendungen und der Komponentenkompatibilität. Darüber hinaus wird bei allen Katun Performance-Produkten ein Jahr lang gewährleistet, dass diese frei von funktionalen Material- und Verarbeitungsfehlern sind. Selbstverständlich steht Ihnen auch der hochwertige technische Support von Katun zur Verfügung.

Um die Katun Performance-Produkte zu finden, halten Sie in diesem Katalog nach dem Namen Performance  und dem entsprechenden Symbol Ausschau.

Originalprodukte

Sie können verschiedene OEM-Produkte auswählen, die Katun aufgrund der Nachfrage auf dem Markt in sein Produktangebot aufgenommen hat.

Beschichtungstechnologien für Heizwalzen

Minco Manufacturing Incorporated, eine hundertprozentige Tochtergesellschaft der Katun Corporation, ist einer der weltweit führenden Hersteller von Heizwalzen für Kopierer, Faxgeräte und Drucker. Die enge Zusammenarbeit zwischen Katun, Minco und DuPont, dem alleinigen Hersteller originaler TEFLON®-Beschichtungen, hat zur Entwicklung von zahlreichen neuartigen Beschichtungsmaterialien für Heizwalzen geführt:

DURAPREM™II Heizwalzen sind mit einer temperaturbeständigen TEFLON® - Antihaft-Beschichtung ausgestattet und besitzen daher eine größere Oberflächenhärte für eine potenziell längere Lebensdauer. Die nach einem speziellen Finish-Verfahren hergestellte, außerordentlich glatte Walzenoberfläche bietet hervorragende Fixier- und Antihaft-Eigenschaften in Geräten mit negativ geladenem Toner.

DURACON™II Heizwalzen sind mit einer temperaturbeständigen TEFLON® - Antihaft-Beschichtung ausgestattet, der patentierte, elektrisch leitfähige Inhaltsstoffe beigemischt sind, um das Ableiten von sich bildender statischer Ladung zu ermöglichen. Diese Heizwalzen zeichnen sich durch ihre hervorragenden Fixier- und Antihaft-Eigenschaften sowie eine lange Nutzungsdauer aus, besonders in Geräten mit positiv geladenem Toner.

ALUMANA™ Heizwalzen besitzen eine äußerst harte, widerstandsfähige Grund- und Zwischenschicht für eine höchstmögliche Verschleißfestigkeit und Haltbarkeit. Die ALUMANA Keramiksicht beinhaltet eine patentierte Polymer-Mischung von DuPont mit Verstärkungsoxiden für eine erhöhte Widerstandsfähigkeit.

Diese robusten Heizwalzen sind speziell für anspruchsvolle Betriebsbedingungen in der Fixierstation und für schnellere Kopierer mit positiv oder negativ geladenem Toner konstruiert.

TRITON™II Heizwalzen zeichnen sich durch ihre hochwertige TEFLON®-Beschichtung aus, die herkömmlichen Fluorpolymer-Beschichtungen in Bezug auf Fixier- und Antihaft-Eigenschaften überlegen ist. Spezielle antistatisch wirkende Partikel in der TRITON II-Beschichtung und hohe Fertigungsstandards tragen zu den ausgezeichneten Antihaft-Eigenschaften und der hervorragenden Verschleißfestigkeit dieser Heizwalzen bei.

Sie bieten potentiell längere Laufzeiten in ausgewählten Geräten sowohl mit positiv als auch mit negativ geladenem Toner.

Central/Eastern Europe

Telephone: 31(0)183-696969

Fax: 31(0)183-629055

E-mail: order@edc.katun.com

TUF/SIL™ Heizwalzen besitzen eine Silikonbeschichtung, die für eine effiziente regulierte Wärmeableitung an den Toner sorgt, sowie eine besonders zusammengesetzte TEFLON® - Beschichtung mit ausgezeichneten Antihaft-Eigenschaften und hoher Verschleißfestigkeit. Dies führt zu weniger Toner-Offsetting-Problemen und gewährleistet auch unter anspruchsvollen Betriebsbedingungen eine gleichbleibend hohe Kopienqualität. Die TEFLON®/SILIKON Heizwalzen bieten ein sehr gutes Preis-/Leistungsverhältnis für ausgewählte Geräte, die höchste Qualitätsansprüche in Bezug auf die Kopienqualität stellen.

MICROSLEEVE™ Presswalzen mit Antihaft-PFA-Ummantelung in den Stärken 50, 70 und 100 µm bieten eine außergewöhnliche Haltbarkeit und damit eine langfristig bessere Kopienqualität und längere Nutzungsdauer. Die Presswalzen der MICROSLEEVE™ A-Serie sind speziell für den Einsatz in Geräten gedacht, bei denen eine Reinigung der unteren Presswalze mittels Reinigungswalze stattfindet.

Ihre besondere Oberflächenstruktur reduziert Tonerablagerungen und verbessert die Reinigungswirkung in der Fixierstation.

Alle Heizwalzen von Katun wurden speziell im Hinblick auf deren Einsatzzweck entwickelt und erfüllen höchste Qualitätsstandards. Nicht umsonst zeichnen sie sich durch eine herausragende Leistung und eine lange Nutzungsdauer aus.

Beschichtungstechnologien für Reinigungswalzen

Katun hat spezielle Reinigungswalzen für Geräte entwickelt, die eine wirksame Beseitigung von Tonerresten und Schmutz sowie eine kontinuierliche Versorgung wichtiger Teile der Fixierstation mit Silikonöl erfordern. Durch den Einsatz einer Katun Reinigungswalze kann bei vielen Geräten eine optimale Kopienqualität und eine größtmögliche Nutzungsdauer der Komponenten erzielt werden.

FIBRA™ Reinigungswalzen entfernen Tonerreste und Schmutzpartikel durch ein spezielles Fasernetz effizient von der Walzenoberfläche. Während das FIBRA-Fasernetz die Verschmutzungen wirkungsvoll in seiner Oberfläche aufnimmt, sorgt es zugleich für eine Dauerversorgung wichtiger Teile der Fixierstation mit Silikonöl aus dem Vorratstank im Walzeninneren.

FIBRA™II Reinigungswalzen besitzen ein neuartiges, hitzebeständiges Fasernetz, mit denen besonders unter anspruchsvollen Betriebsbedingungen eine erheblich verbesserte Reinigungswirkung erzielt wird.

Durch die wirksame Aufnahme von Tonerresten und Schmutzstoffen bei gleichzeitiger Dauerversorgung wichtiger Teile in der Fixierstation mit Silikonöl können die Austausch- und Servicekosten für die Fixierstation erheblich gesenkt werden.

TEFLON® ist ein eingetragenes Warenzeichen von E.I. DuPont de Nemours and Company und wird von der Katun Corporation unter Lizenz verwendet.

Firmenetiketten-Programm

Katun bietet Händlern einen äußerst kostengünstigen Weg, ihre Kunden an sich zu binden und Kundenbeziehungen zu verbessern. Das **Firmenetiketten-Programm** erlaubt es Händlern, qualitativ hochwertige Verbrauchsmaterialien von Katun Performance (Toner, Drucker-/Faxkartuschen, Tinten für Digitalkopierer und Thermotransferrollen) mit ihrem Firmennamen und/oder Logo sowie mit Kontaktinformationen zu versehen. So wissen Verbraucher immer, bei wem sie Produkte nachbestellen können. Für eine einmalige, geringe Bearbeitungsgebühr entwirft und produziert Katun Performance vollfarbige Etiketten nach Ihren eigenen Angaben. Diese werden kostenfrei auf die entsprechenden Verpackungen aufgebracht. Unter dieses Programm fallen nur Produkte, die vom Endverbraucher nachbestellt werden können. Die Teilnahme an dem Programm ist ganz einfach. Füllen Sie einfach die Vereinbarung aus und senden Sie diese an Ihren Katun- Ansprechpartner oder besuchen Sie uns auf unserer Homepage unter Firmenetiketten-Programm für weitere Information zu diesem Programm und den Teilnahmebedingungen.



Personalized Product Agreement

Customer Information

Customer Number: _____ Phone Number: _____
 Contact Name: _____ Fax Number: _____
 Title: _____ Katun Representative: _____

Customer agrees to:

- Provide pertinent information, a scanable copy of your company logo, or other desired label artwork, and color specifications for the labels.
- Pay a one-time, nominal setup fee upon approval of the label design. (Ask your sales representative for details.)
- Order in full master carton quantities.

Katun agrees to:

- Create a personalized, full-color label design to your specifications, per the information provided on page two of this form, for a one-time, nominal setup fee and send a proof for approval within a minimum of 7 days of receipt of this agreement.
- Produce labels printed with the customer's approved design on white label stock, and affix them over the Katun Performance logo* on copier toner, printer/fax toner cartridge, digital duplicator ink/master packaging.
- Ship initial order within one week after the customer approves their Personalized Product label proof. Reorders will also ship within one week.

Projected Personalized Product Purchases

| <i>Katun Part Number**</i> | <i>OEM Line</i> | <i>Product/Model Description</i> | <i>Minimum Order Quantity</i> | <i>Projected Monthly Order***</i> |
|----------------------------|-----------------|----------------------------------|-------------------------------|-----------------------------------|
| P | | | <i>One master carton</i> | |
| P | | | <i>One master carton</i> | |
| P | | | <i>One master carton</i> | |
| P | | | <i>One master carton</i> | |
| P | | | <i>One master carton</i> | |
| P | | | <i>One master carton</i> | |

Signature: _____ Date: _____

*Only Katun Performance products can be personalized.

**The Personalized Product part number is the regular Katun Performance part number with a 'P' added at the end. See the Katun catalog for master carton quantities.

*****Projection only.** You are not committed to ordering the quantity you list on this form.

NOTE: Products with personalized labels cannot be returned to Katun for credit unless a valid warranty claim exists.

Please Also Complete Page 2



Central/Eastern Europe

Telephone: 31(0)183-696969

Fax: 31(0)183-629055

E-mail: order@edc.katun.com

Information for Personalized Product Label

Please list *only* the information you want to appear on your Personalized Product label.

Company Name: _____

Street Address: _____

City: _____

State/Province: _____ **Postal Code:** _____

Phone Number: _____ **Fax Number:** _____

Other: _____

Label Artwork

- **Attach a copy of your company logo and/or any other requested graphic elements.** Artwork may be full color or black and white. We prefer original-quality artwork 4" x 4" (100mm x 100mm) or larger, but will accept a business card or sheet of company letterhead.
- **Please indicate your color preferences.** In the space below, please indicate the color(s) you want to use for all text, your company logo, and any other graphic elements. If appropriate, please supply accurate samples to be matched or specify Pantone or PMS color numbers. **NOTE:** Your labels will be printed on a thermal-transfer printer at a resolution of 300 dpi. Therefore color photographs cannot be printed and some colors may be difficult to match precisely.

Label Sizes

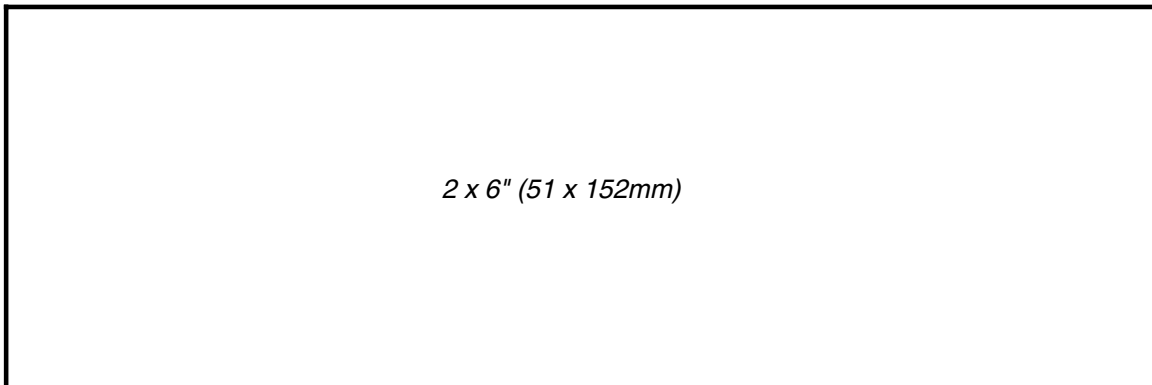
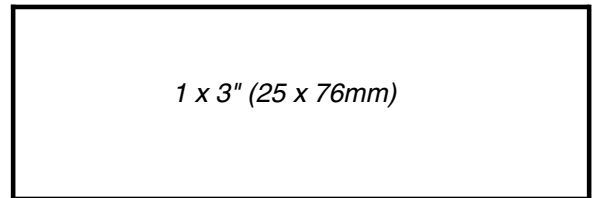
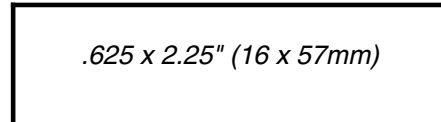
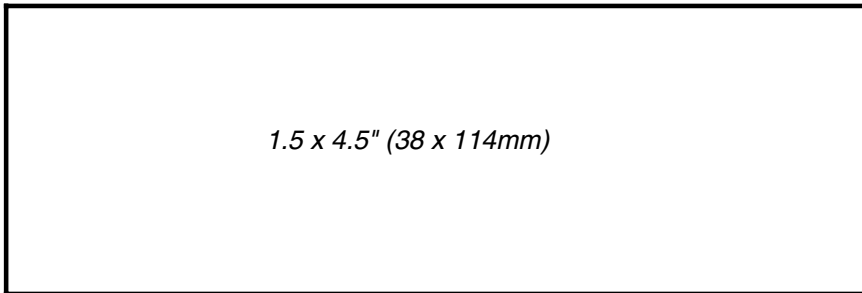

Vereinbarung über Bestellung von Produkten mit Ihrem Firmenetikett

Kundeninformationen

Kundennummer: _____ Telefon: _____
 Ansprechpartner: _____ Fax: _____
 Position: _____ Ihr Katun-Repräsentant: _____

Der Kunde ist einverstanden:

- Katun die benötigten Informationen vorzulegen (ein zum Scannen geeignetes Muster Ihres Firmenlogos bzw. Muster anderer gewünschter Grafikelemente sowie Farbspezifikationen für die Etiketten);
- nach Genehmigung des Etiketten-Layouts eine einmalige, geringe Bearbeitungsgebühr zu entrichten. Weitere Informationen erhalten Sie von Ihrem Katun-Repräsentanten;
- Toner in den jeweiligen Verpackungseinheiten/Umkartons zu bestellen.

Katun verpflichtet sich:

- ein Vollfarbetikett nach den Kundenangaben zu entwerfen (siehe Seite 2 dieses Formulars). Hierfür wird eine einmalige, geringe Bearbeitungsgebühr erhoben. Nach Eingang dieser Vereinbarung bei Katun erhält der Kunde innerhalb von ca. sieben Werktagen einen Korrekturabzug.
- Etiketten in Standardgröße mit dem vom Kunden genehmigten Layout auf weißem Etikettenpapier zu drucken und über dem Katun Performance-Logo* auf der Verpackung von Toner für Kopierer, Tonerkartuschen für Drucker/Faxgeräte, Tinte bzw. deren Umkartons für digitale Duplikatoren anzubringen.
- den Toner-Erstauftrag innerhalb von einer Woche nach Genehmigung des firmeneigenen Etiketts zu versenden. Nachbestellungen werden ebenfalls innerhalb einer Woche erledigt.

Erwartete Abnahmemenge von Produkten mit Ihrem Firmenetikett

| Katun Artikelnummer** | Maschinenlinie | Produkt-/Modellbeschreibung | Mindestmenge | Erwartete monatliche Bestellung*** |
|-----------------------|----------------|-----------------------------|--------------|------------------------------------|
| P | | | Ein Umkarton | |
| P | | | Ein Umkarton | |
| P | | | Ein Umkarton | |
| P | | | Ein Umkarton | |
| P | | | Ein Umkarton | |
| P | | | Ein Umkarton | |

Unterschrift: _____ Datum: _____

*Nur Katun Performance Produkte können mit Firmenetiketten bestellt werden.

**Die Artikelnummer für Produkte mit Ihrem Firmenetikett ist die normale Katun Performance Artikelnummer, der ein "P" am Ende nachgestellt ist. Sehen Sie die Umkartonmengen im Katun-Katalog nach.

***Nur Schätzungen. Sie sind nicht verpflichtet, die hier angegebene Menge abzunehmen.

HINWEIS: Produkte mit Firmenetiketten können nur bei einer berechtigten Reklamation gutgeschrieben werden.

Füllen Sie bitte auch Seite 2 aus.

Bestellinformationen für firmeneigenes Etikett

Geben Sie bitte *nur* die Informationen an, die auf dem Etikett erscheinen sollen.

Name der Firma: _____

Strasse: _____

PLZ/Ort: _____

Telefon: _____ Fax: _____

Sonstiges: _____

Layout des Etiketts

- **Bitte legen Sie kein Muster Ihres Firmenlogos sowie ggf. Muster anderer gewünschter Grafikelemente bei.** Geeignet sind Grafiken in Farbe oder Schwarzweiß, vorzugsweise Originale mit einer Mindestgröße von 100 x 100 mm. Wir können auch Ihre Visitenkarte oder Ihren Briefkopf verarbeiten.
- **Bitte geben Sie die gewünschten Farben an.** Tragen Sie unten bitte die Farbe(n) für alle Textelemente, Ihr Firmenlogo sowie andere grafische Elemente ein. Legen Sie ggf. ein Farbmuster bei, oder geben Sie die Pantone- bzw. PMS-Farbnummern an.
HINWEIS: Ihre Firmenetiketten werden auf einem Thermodrucker mit einer Auflösung von 300 DPI erstellt. Es können daher keine Farbfotos gedruckt werden, und bestimmte Farben können u. U. nicht exakt wiedergegeben werden.





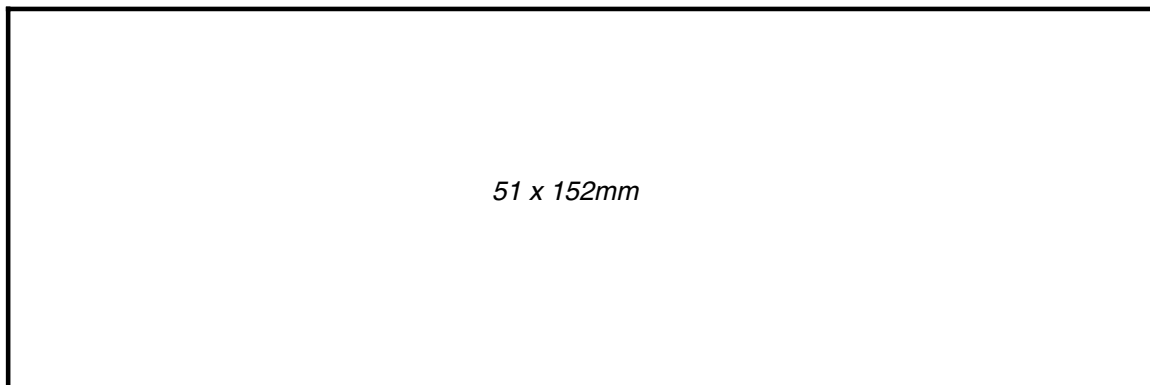
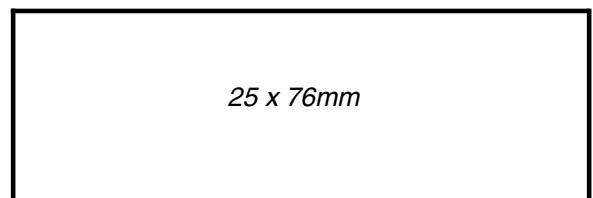
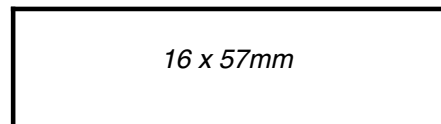
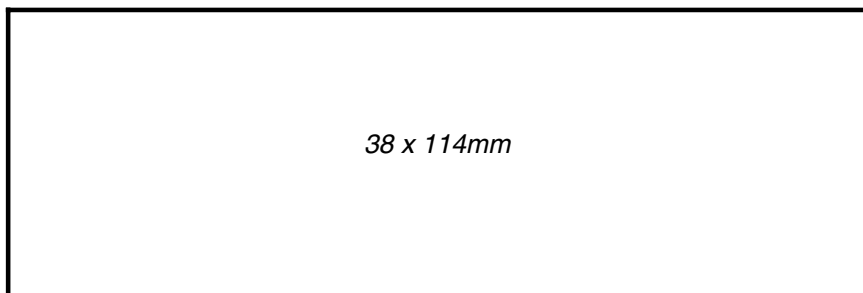













Etikettengrößen



For use in
Ricoh
Copiers













Central/Eastern Europe
Telephone: 31(0)183-696969
Fax: 31(0)183-629055
E-mail: order@edc.katun.com

| OEM PN | KATUN PN | DESCRIPTION | MODEL NO. |
|--------------------------|---|--|--|
| Bearings/Bushings | | | |
| A1904086 | 70016690  | Upper Fuser Roller Bushing | AFICIO 200, FT 3813, FT 4015, FT 4018 |
| | | | <i>Priced per Bushing, sold in Boxes of 10.</i> |
| AE030029 | 70021628  | Upper Fuser Roller Bearing | AFICIO 220, AFICIO 270 |
| G0524618 | 70021628  | Upper Fuser Roller Bearing | AFICIO 220, AFICIO 270, AFICIO 1015, AFICIO 1018, AFICIO 1018 D, AFICIO 1022, AFICIO 1027, AFICIO 2015, AFICIO 2018, AFICIO 2018 D, AFICIO 2022, AFICIO 2027 |
| A2244173 | 70016005  | Upper Fuser Roller Bearing | AFICIO 250 |
| A2323559 | 70021630  | Upper Fuser Roller Bearing | AFICIO 340, AFICIO 350, AFICIO 450 |
| A2323560 | 70576204  | Lower Fuser Roller Bearing | AFICIO 340, AFICIO 350, AFICIO 450 |
| A2323566 | 70576233  | Bearing | AFICIO 340, AFICIO 350, AFICIO 450, AFICIO 550, AFICIO 551, AFICIO 650, AFICIO 700, AFICIO 850, AFICIO 1035, AFICIO 1045, AFICIO 1050, AFICIO 1055, AFICIO 1060, AFICIO 1075, AFICIO 1085, AFICIO 1105, AFICIO 2035, AFICIO 2035 G, AFICIO 2045, AFICIO 2045 G, AFICIO COLOR 3006, AFICIO COLOR 4006, AFICIO COLOR 4106, AFICIO COLOR 6513, RT- 42 |
| A2323553 | 70576118  | Bearing | AFICIO 340, AFICIO 350, AFICIO 450, AFICIO 1022, AFICIO 1027, AFICIO 1035, AFICIO 1045, AFICIO 2022, AFICIO 2027, AFICIO 2035, AFICIO 2035 G, AFICIO 2045, AFICIO 2045 G, AFICIO AP 3800 CMF |
| A2323552 | 70576118  | Bearing | AFICIO 340, AFICIO 350, AFICIO 450, AFICIO 1035, AFICIO 1045, AFICIO 2035, AFICIO 2035 G, AFICIO 2045, AFICIO 2045 G, AFICIO COLOR 6010, AFICIO COLOR 6110, AFICIO COLOR 6513, DF- 67, PS- 360, PS- 380, PS- 390, SR- 730, SR- 740 |
| AE030021 | 70021628  | Upper Fuser Roller Bearing | AFICIO 400, AFICIO 401 |
| 08053368 | 70576233  | Bearing Various Applications | AFICIO 400, AFICIO 401, AFICIO 470 W, AFICIO 500, AFICIO 550, AFICIO 551, AFICIO 650, AFICIO 700, AFICIO 1055, AFICIO 1060, AFICIO 1075, AFICIO COLOR 2003, AFICIO COLOR 2103, AFICIO COLOR 2203, FT 4030, FT 4060, FT 4085, SR- 200, SR- 810 |

| OEM PN | KATUN PN | DESCRIPTION | MODEL NO. |
|--------------------------|---|--|--|
| Bearings/Bushings | | | |
| AE032018 | 70016680  | Heat Insulating Sleeve | AFICIO 400, AFICIO 401, AFICIO 500 |
| | | | <i>Priced per Heat Sleeve, sold in Packages of 10.</i> |
| 07423808 | 70576233  | Bearing Various Applications | AFICIO 400, AFICIO 401, AFICIO 500, AFICIO 550, AFICIO 551, AFICIO 650, AFICIO 700, AFICIO 850, AFICIO 1050, AFICIO 1055, AFICIO 1060, AFICIO 1075, AFICIO 1085, AFICIO 1105, AFICIO COLOR 5106, AFICIO COLOR 5206, AFICIO COLOR 6010, AFICIO COLOR 6110, AFICIO COLOR 6513, FT 5035, FT 5135, FT 5535, FT 5632, FT 5640, FT 5732, FT 5740, FT 5832, FT 5840, FT 6645, FT 6655, FT 6665, FT 7060, FT 7650, FT 7660, FT 7670, FT 7770, FT 7870, FT 8780, FT 8880, FT 8980, FT 8982, FT 9101, FT 9105, FW 830, NC 100, NC 305, NC 5006, NC 8015, NC 8115, DF- 51, DF- 60, DF- 62, DF- 70, PS- 320, RT- 25, RT- 33, RT- 34, RT- 37, RT- 38, RT- 43, SR- 300, SR- 500, SR- 610, SR- 760, SR- 800 |
| AE030022 | 70576221  | Lower Fuser Roller Bearing | AFICIO 400, AFICIO 401, FT 4022, FT 4027, FT 4127, FT 4522, FT 4527, FT 4622, FT 4822, FT 5035, FT 5135, FT 5535, FT 5632, FT 5640, FT 5732, FT 5740, FT 5832, FT 5840 |
| 07403008 | 70576205  | Bearing Various Applications | AFICIO 400, AFICIO 470 W, AFICIO 550, AFICIO 551, AFICIO 650, AFICIO 700, AFICIO 850, AFICIO 1015, AFICIO 1018, AFICIO 1018 D, AFICIO 1050, AFICIO 1055, AFICIO 1085, AFICIO 1105, AFICIO 1224 C, AFICIO 1224 C S/P, AFICIO 1232 C, AFICIO 1232 C S/P, AFICIO 2090, AFICIO 2105, AFICIO COLOR 5106, AFICIO COLOR 5206, DS 320, DS 5330, FT 4022, FT 4027, FT 4127, FT 4227, FT 4427, FT 4460, FT 4480, FT 4522, FT 4527, FT 4622, FT 4727, FT 4822, FT 5000, FT 5010, FT 5035, FT 5135, FT 5233, FT 5433, FT 5520, FT 5535, FT 5540, FT 5550, FT 5560, FT 5570, FT 5580, FT 5590, FT 5632, FT 5640, FT 5732, FT 5733, FT 5740, FT 5832, FT 5840, FT 6620, FT 6750, FT 7950, FT 7960, FT 7970, FT 9101, FT 9105, NC 5006, DF- 60, DF- 62, RT- 30, RT- 33, RT- 42, SR- 200, SR- 400, SR- 700, SR- 760, SR- 900 |
| 52194624 | 70576131  | Lower Fuser Roller Bearing | AFICIO 470 W, FT 7060, FT 9101, FT 9105 |
| AE030027 | 70576221  | Lower Fuser Roller Bearing | AFICIO 500 |













For use in
Ricoh
Copiers

Central/Eastern Europe
Telephone: 31(0)183-696969
Fax: 31(0)183-629055
E-mail: order@edc.katun.com

| OEM PN | KATUN PN | DESCRIPTION | MODEL NO. |
|--------------------------|---|--|---|
| Bearings/Bushings | | | |
| AE030003 | 70021630  | Upper Fuser Roller Bearing Various Applications Front | AFICIO 500, FT 2260, FT 4215, FT 4422, FT 4460, FT 5233, FT 5433, FT 5733 FT 4220, FT 4222, FT 4415, FT 4418, FT 4421 |
| AE030017 | 70015632  | Upper Fuser Roller Bearing | AFICIO 550, AFICIO 551, AFICIO 650, AFICIO 700, AFICIO 1055, AFICIO 1060, AFICIO 1075, FT 6645, FT 6655, FT 6665, FT 7650, FT 7660, FT 7670, FT 7950, FT 7960, FT 7970 |
| AE030018 | 70015633  | Lower Fuser Roller Bearing | AFICIO 550, AFICIO 551, AFICIO 650, AFICIO 700, AFICIO 1055, AFICIO 1060, AFICIO 1075, FT 6645, FT 6655, FT 6665, FT 7650, FT 7660, FT 7670, FT 7950, FT 7960, FT 7970 |
| AE032014 | 70015648  | Heat Insulating Sleeve | AFICIO 550, AFICIO 551, AFICIO 650, AFICIO 700, AFICIO 1060, AFICIO 1075, FT 6645, FT 6655, FT 6665, FT 7650, FT 7660, FT 7670 |
| AE030035 | 70576118  | Bearing | AFICIO 850, AFICIO 1050, AFICIO 1085, AFICIO 1105, AFICIO 2090, AFICIO 2105 |
| AE030047 | 70021630  | Upper Fuser Roller Bearing | AFICIO 1035, AFICIO 1045, AFICIO 2035, AFICIO 2035 G, AFICIO 2045, AFICIO 2045 G |
| AE030048 | 70576204  | Lower Fuser Roller Bearing | AFICIO 1035, AFICIO 1045, AFICIO 2035, AFICIO 2035 G, AFICIO 2045, AFICIO 2045 G |
| 08053104 | 70576205  | Bearing Various Applications Lower Fuser Roller | AFICIO COLOR 2003, AFICIO COLOR 2103, AFICIO COLOR 2203, FT 3320, FT 4215, FT 4220, FT 4222, FT 4418, FT 4421, FT 4430, NC 8015, NC 8115 FT 3020, FT 3050, FT 3060, FT 4227, FT 4427, FT 4480, FT 4727, FT 5000, FT 5010, FT 5050, FT 5070, FT 5233, FT 5433, FT 5733 |
| AE030015 | 70576217  | Upper Fuser Roller Bearing | AFICIO COLOR 3006, AFICIO COLOR 4006, AFICIO COLOR 4106, AFICIO COLOR 5106, AFICIO COLOR 5206, AFICIO COLOR 6010, AFICIO COLOR 6110, NC 305, NC 5006 |
| AE030049 | 70016005  | Upper Fuser Roller Bearing Front | AFICIO COLOR 3506, AFICIO COLOR 4506 |
| B0234559 | 70576204  | Bearing | AFICIO COLOR 6513 |
| AE030039 | 70576217  | Upper Fuser Roller Bearing | AFICIO COLOR 6513, FW 770, FW 780 |
| 08053377 | 70021530  | Upper Fuser Roller Bearing | DS 320, DS 5330, FT 3020, FT 3050, FT 3060, FT 4030, FT 4060, FT 4065, FT 4085, FT 4227, FT 4420, FT 4427, FT 4430, FT 4480, FT 4727, FT 5000, FT 5010, FT 5050, FT 5070, FT 5520, FT 5540, FT 5550, FT 5560, FT 5570, FT 5580, FT 5590, FT 6620, FT 6750 |













*Priced per Heat Sleeve,
sold in Bags of 10.*



















| OEM PN | KATUN PN | DESCRIPTION | MODEL NO. | |
|--------------------------|---|--|---|--|
| Bearings/Bushings | | | | |
| AE032001 | 70576262  | Heat Insulating Sleeve Various Applications Lower | DS 320, DS 5330, FT 4430, FT 5540, FT 5550, FT 5560, FT 5570, FT 5580, FT 5590, FT 6620, FT 6750 FT 7770, FT 7870, FT 8780, FT 8880, FT 8980, FT 8982 | <i>Priced per Heat Sleeve, sold in Packages of 10.</i> |
| 08053291 | 70576233  | Bearing Various Applications | DS 5330, FT 3020, FT 3050, FT 4480, FT 5000, FT 5010, FT 5520, FT 5540, FT 5550, FT 5560, FT 5570, FT 5580, FT 5590, FT 6080, FT 6085, FT 6620, FT 6645, FT 6655, FT 6665, FT 6750, FT 7650, FT 7660, FT 7670, FT 7770, FT 7870, FT 7950, FT 7960, FT 7970, FT 8780, FT 8880, FT 8980, FT 8982, ARDF, CS- 2065, DF- 34, DF- 51, DF- 38/39, DH- 400, DH- 500, PS- 220, RT- 25, ST- 20, ST- 21, ST- 22, ST- 23 A, ST- 23 B, ST- 27 A, ST- 27 B | |
| 52054321 | 70576210  | Heat Insulating Sleeve | FT 3020, FT 3050, FT 3060, FT 4030, FT 4060, FT 4065, FT 4085, FT 4420, FT 4430, FT 4480, FT 5000, FT 5010, FT 5050, FT 5070, FT 5520 | <i>Priced per Heat Sleeve, sold in Bags of 10.</i> |
| AE030023 | 70021628  | Upper Fuser Roller Bearing | FT 4022, FT 4027, FT 4127, FT 4522, FT 4527, FT 4622, FT 4822, FT 5035, FT 5135, FT 5535, FT 5632, FT 5732, FT 5832 | |
| AE030002 | 70576107  | Lower Fuser Roller Bearing | FT 5540, FT 5550, FT 5570, FT 5580, FT 5590, FT 6620, FT 6750, NC 305 | |
| AE030026 | 70021630  | Upper Fuser Roller Bearing | FT 5640, FT 5740, FT 5840 | |
| 08053087 | 70576107  | Bearing Various Applications | FT 6080, FT 6085, FT 7060, FT 7770, FT 7870 | |
| 08053300 | 70576204  | Bearing Various Applications | FT 6080, FT 6085, FT 7060, FT 7770, FT 7870 | |
| AE030010 | 70576216  | Upper Fuser Roller Bearing | FT 6080, FT 6085, FT 7060, FT 7770, FT 7870, FT 8780, FT 8880, FT 8980, FT 8982 | |
| 54464090 | 70021526  | Upper Fuser Roller Bearing | FT 6080, FT 6085, FT 7060, FT 9101, FT 9105 | |
| AE030011 | 70576224  | Lower Fuser Roller Bearing | FT 7770, FT 7870, FT 8780, FT 8880, FT 8980, FT 8982 | |
| AE032020 | 70015648  | Heat Insulating Sleeve | FT 7950, FT 7960, FT 7970 | <i>Priced per Heat Sleeve, sold in Bags of 10.</i> |
| 08053036 | 70576118  | Bearing Various Applications | FT 9101 | |

For use in
Ricoh
Copiers

Central/Eastern Europe
Telephone: 31(0)183-696969
Fax: 31(0)183-629055
E-mail: order@edc.katun.com















| OEM PN | KATUN PN | DESCRIPTION | MODEL NO. |
|------------------------------------|---|------------------------------------|---|
| Belts | | | |
| A6801481 | 70017565  | Original Document Feed Belt | AFICIO 340, AFICIO 350, AFICIO 450, AFICIO 550, AFICIO 650, DF- 67 |
| A2323880 | 70018006  | Transfer Belt | AFICIO 340, AFICIO 350, AFICIO 450, AFICIO 1035, AFICIO 1045, AFICIO 2035, AFICIO 2035 G, AFICIO 2045, AFICIO 2045 G |
| A1343850 | 70018005  | Transfer Belt | AFICIO 400, AFICIO 401, AFICIO 500 |
| A2293852 | 70018005  | Transfer Belt | AFICIO 550, AFICIO 650, AFICIO 850 |
| A2293899 | 70018005  | Transfer Belt | AFICIO 550, AFICIO 650, AFICIO 850, AFICIO 1050 |
| A2943962 | 70018005  | Transfer Belt | AFICIO 550, AFICIO 650, AFICIO 850, AFICIO 1050 |
| A2933899 | 70018005  | Transfer Belt | AFICIO 551, AFICIO 700, AFICIO 1055, AFICIO 1060, AFICIO 1075, AFICIO 2090, AFICIO 2105 |
| A1573870 | 70018007  | Transfer Belt | FT 4022, FT 4027, FT 4127, FT 4522, FT 4527, FT 4622, FT 4822, FT 5632, FT 5732, FT 5832 |
| A1763870 | 70017823  | Transfer Belt | FT 5035, FT 5135, FT 5535, FT 5640, FT 5740, FT 5840, FT 6645, FT 6655, FT 6665, FT 7650, FT 7660, FT 7670, FT 7950, FT 7960, FT 7970 |
| A4651127 | 70016610  | Original Document Feed Belt | DF- 40, DF- 41, DF- 54, DF- 57, DF- 58 |
| A4971125 <i>Final Inventory</i> | 70012185  | Original Document Feed Belt | DF- 56, DH- 400, DH- 500 |
| A3762196 | 70018572  | Original Document Feed Belt | DF- 60, DF- 62 |
| A5481482 | 70014087  | Original Document Feed Belt | DF- 61, DF- 64 |

| OEM PN | KATUN PN | DESCRIPTION | MODEL NO. |
|-----------------------|---|--|---|
| Blades/Brushes | | | |
| G0203550 | 70016219  | Drum Cleaning Blade | AFICIO 200, AFICIO 250 |
| N/P/N | 70021494  | Drum Cleaning Blade | AFICIO 220, AFICIO 270, AFICIO 1022, AFICIO 1027, AFICIO 1032, AFICIO 2022, AFICIO 2027 |
| A2322353 | 70017343  | Drum Cleaning Blade Assembly | AFICIO 340, AFICIO 350, AFICIO 450, AFICIO 1035, AFICIO 1045 |
| A2323830 | 70018035  | Transfer Belt Cleaning Blade | AFICIO 340, AFICIO 350, AFICIO 450, AFICIO 1035, AFICIO 1045, AFICIO 2035, AFICIO 2035 G, AFICIO 2045, AFICIO 2045 G |
| A1342275 | 70016734  | Drum Cleaning Blade | AFICIO 400, AFICIO 401, AFICIO 500 |
| A1343945 | 70018666  | Transfer Belt Cleaning Blade | AFICIO 400, AFICIO 401, AFICIO 500 |
| AD041056 | 70012544  | Drum Cleaning Blade | AFICIO 550, AFICIO 551, AFICIO 650, AFICIO 700, AFICIO 850, AFICIO 1050, AFICIO 1055, AFICIO 1085, AFICIO 1105, AFICIO 2090, AFICIO 2105 |
| AD041049 | 70018852  | Transfer Belt Cleaning Blade | AFICIO 550, AFICIO 650 |
| AD042038 | 70023241  | Drum Cleaning Brush Various Applications with Enhancement Kit | AFICIO 550, AFICIO 650, AFICIO 1085, AFICIO 1105, AFICIO 2090, AFICIO 2105 AFICIO 850, AFICIO 1050 |
| A2933918 | 70019862  | Transfer Belt Cleaning Blade | AFICIO 551, AFICIO 700, AFICIO 1055 |
| A2943883 | 70019861  | Transfer Belt Cleaning Blade | AFICIO 850, AFICIO 1050, AFICIO 1085, AFICIO 1105 |
| B0392289 | 70021585  | Drum Cleaning Blade | AFICIO 1015, AFICIO 1018, AFICIO 1018 D |
| 52154117 | 70009414  | Fuser Oil Blade | DS 320, DS 5330, FT 4430, FT 4470, FT 4480, FT 4490, FT 5000, FT 5010, FT 5520, FT 5560 |
| A0123580 | 70011201  | Bias Roller Cleaning Blade | DS 320, FT 5540, FT 5550, FT 5560, FT 5570, FT 5580, FT 5590, FT 6620 |
| AD002044 | 70012935  | Drum Cleaning Blade | FT 3013, FT 3213, FT 3513, FT 3713 |
| AD002044 | 70022578 | Drum Cleaning Blade Access By Katun | FT 3013, FT 3213, FT 3513, FT 3713 |
| AD002018 | 70010492  | Drum Cleaning Blade | FT 3113, FT 3313, FT 3413 |
| A1903550 | 70016502  | Drum Cleaning Blade | FT 3613, FT 3813, FT 4015, FT 4018, FT 4615, FT 4618 |



For use in
Ricoh
Copiers

Central/Eastern Europe
Telephone: 31(0)183-696969
Fax: 31(0)183-629055
E-mail: order@edc.katun.com

| OEM PN | KATUN PN | DESCRIPTION | MODEL NO. |
|------------------------------------|---|--|---|
| Blades/Brushes | | | |
| A1903550 | 70022579 | Drum Cleaning Blade Access By Katun | FT 3613, FT 3813, FT 4015, FT 4018, FT 4615, FT 4618 |
| A1532277 | 70016042  | Drum Cleaning Blade | FT 4022, FT 4027, FT 4127, FT 4522, FT 4527, FT 4622, FT 4822, FT 5035, FT 5135, FT 5535, FT 5632, FT 5640, FT 5732, FT 5740, FT 5832, FT 5840 |
| A1533892 | 70013283  | Transfer Belt Cleaning Blade | FT 4022, FT 4027, FT 4127, FT 4522, FT 4527, FT 4622, FT 4822, FT 5035, FT 5135, FT 5535, FT 5632, FT 5640, FT 5732, FT 5740, FT 5832, FT 5840 |
| A2042120 | 70016230  | Drum Charge Roller Cleaning Blade | FT 4022, FT 4027, FT 4127, FT 4522, FT 4527, FT 4622, FT 4822, FT 5035, FT 5135, FT 5535, FT 5632, FT 5640, FT 5732, FT 5740, FT 5832, FT 5840 |
| 52093565 <i>Final Inventory</i> | 70243444  | Drum Cleaning Blade USA Designed to minimize noise. | FT 4030, FT 4060, FT 4085 |
| 52113568 <i>Final Inventory</i> | 70243444  | Drum Cleaning Blade USA Designed to minimize noise. | FT 4065, FT 4420 |
| A1283562 | 70015470  | Drum Cleaning Blade | FT 4215, FT 4422 |
| A0483565 | 70000719  | Drum Cleaning Blade | FT 4220, FT 4222, FT 4415, FT 4418, FT 4421, FT 4460 |
| AD042011 | 70012707  | Drum Cleaning Brush Looped Type | FT 4220, FT 4222, FT 4415, FT 4418, FT 4421, FT 4460 |
| AD002017 | 70011819  | Drum Cleaning Blade | FT 4227, FT 4427, FT 4727, FT 5233, FT 5433, FT 5733 |
| AD042016 | 70012707  | Drum Cleaning Brush Looped Type | FT 4227, FT 4427, FT 4727, FT 5233, FT 5433, FT 5733 |
| A0073565 | 70244536  | Drum Cleaning Blade | FT 4430, FT 4470, FT 4480, FT 4490, FT 5000, FT 5010, FT 5050, FT 5070, FT 5520, FT 5540, FT 5550, FT 5560, FT 5570, FT 5580, FT 5590, FT 6620 |
| AD042015 | 70236335  | Drum Cleaning Brush | FT 5540, FT 5550, FT 5570, FT 5580, FT 5590, FT 6620, FT 6750 |
| AE043003 | 70009413  | Fuser Oil Blade | FT 5540, FT 5550, FT 5570, FT 5580, FT 5590, FT 6620, FT 6750, NC 100, NC 305, NC 8015, NC 8115 |
| AD042023 | 70012552  | Drum Cleaning Brush | FT 6645, FT 6655, FT 6665 |
| A0963938 | 70016438  | Transfer Belt Cleaning Blade | FT 6645, FT 6655, FT 6665, FT 7650, FT 7660, FT 7670 |







Katun Performance Product

© 2004 Katun Corporation

13 September 2004 For the most current product and pricing information, visit the Katun On-Line Catalog at www.katun.com.









Prices, terms and conditions are subject to change without notice.

| OEM PN | KATUN PN | DESCRIPTION | MODEL NO. |
|-----------------------|---|--|--|
| Blades/Brushes | | | |
| AD042032 | 70019441  | Drum Cleaning Brush | FT 6645, FT 6655, FT 6665, FT 7650, FT 7660, FT 7670 |
| A1763582 | 70012544  | Drum Cleaning Blade | FT 6645, FT 6655, FT 6665, FT 7650, FT 7660, FT 7670, FT 7950, FT 7960, FT 7970 |
| A0533663 | 70011721  | Drum Cleaning Blade | FT 6750 |
| A0793618 | 70011803  | Drum Cleaning Blade | FT 8780, FT 8880, FT 8980, FT 8982 |
| A1093598 | 70014609  | Drum/Transfer Belt Cleaning Blade | NC 5006 |



For use in
Ricoh
Copiers

Central/Eastern Europe
Telephone: 31(0)183-696969
Fax: 31(0)183-629055
E-mail: order@edc.katun.com

| OEM PN | KATUN PN | DESCRIPTION | MODEL NO. |
|-------------------------------|---|--|---|
| Corona/Charge/Transfer | | | |
| A0962057 | 70013164  | Charge Corona Grid | AFICIO 400, AFICIO 401, AFICIO 500, AFICIO 550, AFICIO 551, AFICIO 650, AFICIO 700, AFICIO 850, AFICIO 1050, AFICIO 1055, AFICIO 1060, AFICIO 1075, AFICIO 1085, AFICIO 1105, AFICIO 2090, AFICIO 2105, FT 6645, FT 6655, FT 6665, FT 7650, FT 7660, FT 7670, FT 7950, FT 7960, FT 7970 |
| AD020053 | 70011439  | Corona Wire 60µ Polished Charge | AFICIO 400, AFICIO 401, AFICIO 500, AFICIO 550, AFICIO 551, AFICIO 650, AFICIO 700, AFICIO 850, AFICIO 1050, AFICIO 1060, AFICIO 1075, AFICIO 1085, AFICIO 1105, FT 6645, FT 6655, FT 6665, FT 7650, FT 7660, FT 7670, FT 7950, FT 7960, FT 7970 |
| N/P/N | 70375230  | Corona Wire Spool Platinum alloy clad technology extends corona wire life. 80µ 7.5 m / Spool All Applications | DS 320, FT 3020, FT 3050, FT 3060, FT 3320, FT 4030, FT 4060, FT 4065, FT 4085, FT 4420, FT 4430, FT 4470, FT 4480, FT 4490, FT 5000, FT 5010, FT 5050, FT 5070, FT 5520, FT 5540, FT 5550, FT 5560, FT 5570, FT 5580, FT 5590, FT 6080, FT 6085, FT 6620, FT 6750, FT 7060, FT 7770, FT 7870, FT 8780, FT 8880, FW 420 |
| A0772072 | 70013168  | Charge Corona Grid | FT 3013, FT 3113, FT 3213, FT 3313, FT 3413, FT 3513, FT 3713 |
| A0779520 | 70011933  | Corona Wire 60µ Polished Charge | FT 3013, FT 3113, FT 3213, FT 3313, FT 3413, FT 3513, FT 3713 |
| A0779521 | 70010982  | Corona Wire 60µ Carbon Coated Separation | FT 3013, FT 3113, FT 3213, FT 3313, FT 3413, FT 3513, FT 3713 |
| A0779522 | 70011934  | Corona Wire 60µ Polished Transfer | FT 3013, FT 3113, FT 3213, FT 3313, FT 3413, FT 3513, FT 3713 |
| A1902060 | 70016705  | Charge Corona Grid | FT 3613, FT 3813, FT 4015, FT 4018, FT 4615, FT 4618 |











*Priced per Set,
10 Corona Wires per Set.*

*Priced per Set,
10 Corona Wires per Set.*

*Priced per Set,
10 Corona Wires per Set.*

*Priced per Set,
10 Corona Wires per Set.*











| OEM PN | KATUN PN | DESCRIPTION | MODEL NO. |
|------------------------------------|---|--|--|
| Corona/Charge/Transfer | | | |
| A1902065 | 70015564  | Corona Wire 60μ Polished Charge | FT 3613, FT 3813, FT 4015, FT 4018, FT 4615, FT 4618 <i>Priced per Set, 10 Corona Wires per Set.</i> |
| AD027001 <i>Final Inventory</i> | 70022700  | Drum Charge Roller | FT 4022, FT 4027, FT 4127, FT 4522, FT 4527, FT 5035, FT 5135, FT 5535 |
| A0062111 | 70013165  | Charge Corona Grid | FT 4215, FT 4220, FT 4222, FT 4415, FT 4418, FT 4421, FT 4422 |
| A0489001 | 70375164  | Corona Wire 60μ Polished Charge | FT 4215, FT 4220, FT 4222, FT 4415, FT 4418, FT 4421, FT 4422 <i>Priced per Set, 10 Corona Wires per Set.</i> |
| A0489002 | 70375165  | Corona Wire 60μ Polished Transfer | FT 4215, FT 4220, FT 4222, FT 4415, FT 4418, FT 4421, FT 4422 <i>Priced per Set, 10 Corona Wires per Set.</i> |
| A0489003 | 70375166  | Corona Wire 60μ Carbon Coated Separation | FT 4215, FT 4220, FT 4222, FT 4415, FT 4418, FT 4421, FT 4422 <i>Priced per Set, 10 Corona Wires per Set.</i> |
| A0692117 | 70013166  | Charge Corona Grid | FT 4227, FT 4427, FT 4727, FT 5233, FT 5433, FT 5733 |
| A0699540 | 70011931  | Corona Wire 60μ Polished Charge | FT 4227, FT 4427, FT 4727, FT 5233, FT 5433, FT 5733 <i>Priced per Set, 10 Corona Wires per Set.</i> |
| A0699541 | 70011932  | Corona Wire 60μ Polished Transfer | FT 4227, FT 4427, FT 4727, FT 5233, FT 5433, FT 5733 <i>Priced per Set, 10 Corona Wires per Set.</i> |
| A0699542 | 70011874  | Corona Wire 60μ Carbon Coated Separation | FT 4227, FT 4427, FT 4727, FT 5233, FT 5433, FT 5733 <i>Priced per Set, 10 Corona Wires per Set.</i> |
| A0089001 | 70375593  | Corona Wire 80μ Carbon Coated Charge | FT 5540, FT 5550, FT 5560, FT 5570, FT 5580, FT 5590, FT 6620, FT 6750 <i>Priced per Set, 10 Corona Wires per Set.</i> |





For use in
Ricoh
Copiers

Central/Eastern Europe
Telephone: 31(0)183-696969
Fax: 31(0)183-629055
E-mail: order@edc.katun.com

| OEM PN | KATUN PN | DESCRIPTION | MODEL NO. |
|-------------------------------|---|---|---|
| Corona/Charge/Transfer | | | |
| A0079002 | 70375592  | Corona Wire 80μ Carbon Coated Precleaning, Prequenching | FT 5540, FT 5550, FT 5570, FT 5580, FT 5590, FT 6620, FT 6750 <i>Priced per Set, 10 Corona Wires per Set.</i> |
| A0079003 | 70375595  | Corona Wire 80μ Carbon Coated Transfer | FT 5540, FT 5550, FT 5570, FT 5580, FT 5590, FT 6620, FT 6750 <i>Priced per Set, 10 Corona Wires per Set.</i> |
| A0079004 | 70375594  | Corona Wire 80μ Carbon Coated Separation | FT 5540, FT 5550, FT 5570, FT 5580, FT 5590, FT 6620, FT 6750 <i>Priced per Set, 10 Corona Wires per Set.</i> |
| 52199101 | 70375591  | Corona Wire 80μ Carbon Coated All Applications | FT 7060, FT 7770, FT 7870, FT 8780, FT 8880 <i>Priced per Set, 10 Corona Wires per Set.</i> |
| 52199535 | 70375591  | Corona Wire 80μ Carbon Coated All Applications | FT 7060, FT 7770, FT 7870, FT 8780, FT 8880 <i>Priced per Set, 10 Corona Wires per Set.</i> |
| A1719504 | 70375591  | Corona Wire 80μ Carbon Coated All Applications | FT 8780, FT 8880, FT 8980, FT 8982 <i>Priced per Set, 10 Corona Wires per Set.</i> |
| N/P/N | 70375553  | Corona Wire Spool 50 m / Spool 80μ Polished All Applications | FW 420 |
| A9433304 | 70375547  | Corona Wire Spool 50 m / Spool 80μ 0.3μ Gold Plated All Applications | LR 1 |



| OEM PN | KATUN PN | DESCRIPTION | MODEL NO. |
|----------------------------------|---|--|---|
| Developers | | | |
| 887733 | 70018459 | Black Developer Original 500 g / Bag | AFICIO 340, AFICIO 350, AFICIO 450 |
| 887637 | 70017101 | Black Developer Original 850 g / Bag | AFICIO 400, AFICIO 401, AFICIO 500 |
| 887748 | 70018460 | Black Developer Original 1000 g / Bag | AFICIO 550, AFICIO 650 |
| 888002 | 70023201 | Black Developer Original 1000 g / Bag | AFICIO 551, AFICIO 700, AFICIO 1055 |
| 888073 | 70021476 | Black Developer Original 500 g / Bag | AFICIO 1035, AFICIO 1045 |
| 888190 | 70023865 | Black Developer Original | AFICIO 2035, AFICIO 2035 G, AFICIO 2045, AFICIO 2045 G |
| 918008 | 70010887  | Black Developer 1000 g / Bottle 4 Bottles per Master Carton | DS 320, FT 3020, FT 3050, FT 3060, FT 4030, FT 4060, FT 4065, FT 4085, FT 4420, FT 4430, FT 4470, FT 4480, FT 4490, FT 5000, FT 5010, FT 5050, FT 5070, FT 5520, FT 5540, FT 5550, FT 5560, FT 5570, FT 5580, FT 5590, FT 6080, FT 6085, FT 6620, FT 7060, FT 7770, FT 7870 |
| 918008 <i>Final Inventory</i> | 70013566 | Black Developer Original 1000 g / Bottle | DS 320, FT 3020, FT 3050, FT 3060, FT 4030, FT 4060, FT 4065, FT 4085, FT 4420, FT 4430, FT 4470, FT 4480, FT 4490, FT 5000, FT 5010, FT 5050, FT 5070, FT 5520, FT 5540, FT 5550, FT 5560, FT 5570, FT 5580, FT 5590, FT 6080, FT 6085, FT 6620, FT 7060, FT 7770, FT 7870 |
| 887576 <i>Final Inventory</i> | 70013926  | Black Developer 1000 g / Bottle 4 Bottles per Master Carton | DS 5330, FT 6750 |
| 889268 | 70013563 | Black Developer Original 1000 g / Bag | FT 3013, FT 3113, FT 3213, FT 3313, FT 3413, FT 3513, FT 3713, FT 4227, FT 4422, FT 4427, FT 4727, FT 5233, FT 5433, FT 5733 |
| 889855 | 70016407 | Black Developer Original 370 g / Bag | FT 3613, FT 3813, FT 4015, FT 4018, FT 4615, FT 4618 |
| 885176 | 70013599 | Black Developer Original 1000 g / Bag | FT 4022, FT 4027, FT 4127, FT 4522, FT 4527, FT 4622, FT 4822, FT 5035, FT 5135, FT 5535, FT 5632, FT 5740, FT 5832, FT 5840, FT 6645, FT 6655, FT 6665, FT 7650, FT 7660, FT 7670 |
| 887564 | 70013565 | Black Developer Original 1000 g / Bag | FT 4215, FT 4222, FT 4415, FT 4418, FT 4421, FT 4460 |

*Priced per Carton,
4 Bottles per Carton.*

*Priced per Carton,
4 Bottles per Carton.*

For use in
Ricoh
Copiers













Central/Eastern Europe
Telephone: 31(0)183-696969
Fax: 31(0)183-629055
E-mail: order@edc.katun.com

| OEM PN | KATUN PN | DESCRIPTION | MODEL NO. |
|-----------|-------------|-------------|--------------|
|-----------|-------------|-------------|--------------|

Developers









| | | | |
|--------|----------|---|---------------------------|
| 887797 | 70019853 | Black Developer Original 1000 g / Bag | FT 7950, FT 7960, FT 7970 |
|--------|----------|---|---------------------------|



| OEM PN | KATUN PN | DESCRIPTION | MODEL NO. | |
|----------------------|---|---|---|---|
| Feed/Delivery | | | | |
| G0202721 | 70019647  | Bypass Feed Roller Tire Only | AFICIO 200, AFICIO 250, FT 3613, FT 3813, FT 4015, FT 4018, FT 4615, FT 4618 | <i>Priced per Tire, sold in Bags of 10.</i> |
| A2192555 | 70020085  | Paper Feed Roller | AFICIO 200, AFICIO 250, FT 3613, FT 3813, FT 4015, FT 4018, FT 4615, FT 4618, FT 4622, FT 4822 | <i>Priced per Feed/Sep Roller, sold in Bags of 4.</i> |
| A2672751 | 70018175  | Paper Feed Roller | AFICIO 220, AFICIO 270, AFICIO 1022, AFICIO 1027, AFICIO 2022, AFICIO 2027, PS- 400, PS- 410, PS- 440, PS- 450, PS- 460, PS- 490 | |
| AF013014 | 70015686  | Bottom Plate Friction Pad Cork Type | AFICIO 340, AFICIO 350, AFICIO 400, AFICIO 401, AFICIO 450, AFICIO 500, AFICIO COLOR 3006, AFICIO COLOR 3506, AFICIO COLOR 6010, AFICIO COLOR 6110, AFICIO COLOR 6513, FT 5035, FT 5135, FT 5535, FT 5632, FT 5640, FT 5732, FT 5740, FT 5832, FT 5840, PS- 280, PS- 290, PS- 360, PS- 380, PS- 390 | <i>Priced per Friction Pad, sold in Bags of 10.</i> |
| A6801241 | 70017521  | Paper Feed Belt | AFICIO 340, AFICIO 350, AFICIO 450, AFICIO 550, AFICIO 551, AFICIO 650, AFICIO 700, DF- 67 | |
| AF030036 | 70018482  | Bypass Pickup Roller Tire Only | AFICIO 340, AFICIO 350, AFICIO 450, AFICIO 1035, AFICIO 1045 | <i>Priced per Tire, sold in Bags of 10.</i> |
| AF031036 | 70018484  | Bypass Feed Roller Tire Only | AFICIO 340, AFICIO 350, AFICIO 450, AFICIO 1035, AFICIO 1045 | <i>Priced per Tire, sold in Bags of 10.</i> |
| AF032036 | 70018483  | Bypass Separation Roller Tire Only | AFICIO 340, AFICIO 350, AFICIO 450, AFICIO 1035, AFICIO 1045 | <i>Priced per Tire, sold in Bags of 10.</i> |
| N/P/N | 70020136  | Paper Feed Roller Kit Tire Only For KD 1010 Kit Contains: • (1) Paper Pickup Tire • (1) Separation/Feed Tire • (1) Paper Feed Tire | AFICIO 340, AFICIO 350, AFICIO 450, AFICIO 1035, AFICIO 1045, AFICIO COLOR 3006, AFICIO COLOR 3506, PS- 360, PS- 380, PS- 390, PS- 420 | |
| AF031035 | 70018484  | Paper Feed Roller Tire Only | AFICIO 340, AFICIO 350, AFICIO 450, AFICIO 1035, AFICIO 1045, AFICIO COLOR 3006, AFICIO COLOR 3506, PS- 360, PS- 380, PS- 390, PS- 420, PS- 500 | <i>Priced per Tire, sold in Bags of 10.</i> |
| AF032035 | 70018483  | Separation Roller Tire Only | AFICIO 340, AFICIO 350, AFICIO 450, AFICIO 1035, AFICIO 1045, AFICIO COLOR 3006, AFICIO COLOR 3506, PS- 360, PS- 380, PS- 390, PS- 420, PS- 500 | <i>Priced per Tire, sold in Bags of 10.</i> |
| AF030035 | 70018482  | Paper Pickup Roller Tire Only | AFICIO 340, AFICIO 350, AFICIO 450, AFICIO COLOR 3006, AFICIO COLOR 3506, PS- 360, PS- 380, PS- 390, PS- 420, PS- 500 | <i>Priced per Tire, sold in Bags of 10.</i> |

For use in
Ricoh
Copiers

Central/Eastern Europe
Telephone: 31(0)183-696969
Fax: 31(0)183-629055
E-mail: order@edc.katun.com











| OEM PN | KATUN PN | DESCRIPTION | MODEL NO. | |
|----------------------|---|--|---|---|
| Feed/Delivery | | | | |
| 54472927 | 70014401  | Friction Pad B Cork Type | AFICIO 400, AFICIO 401, AFICIO 500, AFICIO COLOR 2003, AFICIO COLOR 2103, AFICIO COLOR 2203, AFICIO COLOR 5106, AFICIO COLOR 5206, DS 5330, FT 3320, FT 4220, FT 4222, FT 4227, FT 4418, FT 4420, FT 4421, FT 4422, FT 4427, FT 4622, FT 4727, FT 4822, FT 5000, FT 5010, FT 5050, FT 5070, FT 5233, FT 5433, FT 5540, FT 5570, FT 5580, FT 5590, FT 5632, FT 5640, FT 5732, FT 5733, FT 5740, FT 5832, FT 5840, FT 6620, NC 5006, NC 8015 | <i>Priced per Friction Pad, sold in Bags of 10.</i> |
| AF013003 | 70015684  | Duplex Friction Pad Cork Type | AFICIO 400, AFICIO 401, AFICIO 500, AFICIO COLOR 4006, AFICIO COLOR 4106, AFICIO COLOR 4506, AFICIO COLOR 6010, AFICIO COLOR 6110, AFICIO COLOR 6513, FT 4022, FT 4027, FT 4127, FT 4227, FT 4427, FT 4522, FT 4527, FT 4622, FT 4727, FT 4822, FT 5035, FT 5135, FT 5233, FT 5433, FT 5535, FT 5632, FT 5640, FT 5732, FT 5733, FT 5740, FT 5832, FT 5840 | <i>Priced per Friction Pad, sold in Bags of 10.</i> |
| AF030031 | 70016930  | LCT Bypass Pickup Roller Tire Only | AFICIO 400, AFICIO 401, AFICIO 500, AFICIO COLOR 6010, AFICIO COLOR 6110, AFICIO COLOR 6513 | <i>Priced per Tire, sold in Bags of 10.</i> |
| AF031031 | 70016931  | LCT Bypass Feed Roller Tire Only | AFICIO 400, AFICIO 401, AFICIO 500, AFICIO COLOR 6010, AFICIO COLOR 6110, AFICIO COLOR 6513 | <i>Priced per Tire, sold in Bags of 10.</i> |
| AF030025 | 70013252  | Paper Pickup Roller Tire Only | AFICIO 400, AFICIO 401, AFICIO 500, AFICIO COLOR 6010, AFICIO COLOR 6110, AFICIO COLOR 6513, FT 5035, FT 5135, FT 5535, FT 5632, FT 5640, FT 5732, FT 5740, FT 5832, FT 5840, PS- 280, PS- 290 | <i>Priced per Tire, sold in Bags of 10.</i> |
| AF031026 | 70010496  | Paper Feed Roller Tire Only | AFICIO 400, AFICIO 401, AFICIO 500, AFICIO COLOR 6010, AFICIO COLOR 6110, AFICIO COLOR 6513, FT 5035, FT 5135, FT 5535, FT 5632, FT 5640, FT 5732, FT 5740, FT 5832, FT 5840, PS- 280, PS- 290 | <i>Priced per Tire, sold in Bags of 10.</i> |
| AF032027 | 70013047  | Separation Roller Tire Only | AFICIO 400, AFICIO 401, AFICIO 500, AFICIO COLOR 6010, AFICIO COLOR 6110, AFICIO COLOR 6513, FT 5035, FT 5135, FT 5535, FT 5632, FT 5640, FT 5732, FT 5740, FT 5832, FT 5840, PS- 280, PS- 290 | <i>Priced per Tire, sold in Bags of 10.</i> |
| A4212543 | 70015507  | Friction Pad Cork Type | AFICIO 400, AFICIO 401, AFICIO 500, FT 4022, FT 4027, FT 4127, FT 4522, FT 4527, FT 4622, FT 4822, FT 5035, FT 5135, FT 5233, FT 5433, FT 5535, FT 5632, FT 5640, FT 5732, FT 5733, FT 5740, FT 5832, FT 5840, PS- 420, PS- 500, RT- 37, RT- 38, RT- 43 | <i>Priced per Friction Pad, sold in Bags of 10.</i> |













| OEM PN | KATUN PN | DESCRIPTION | MODEL NO. | |
|----------------------|---|---|--|---|
| Feed/Delivery | | | | |
| AF031024 | 70017811  | Paper Feed Roller Tire Only For duplex unit only | AFICIO 400, AFICIO 401, AFICIO 500, FT 4022, FT 4027, FT 4127, FT 4522, FT 4527, FT 4622, FT 4822, FT 5035, FT 5135, FT 5535, FT 5632, FT 5640, FT 5732, FT 5740, FT 5832, FT 5840 | <i>Priced per Tire, sold in Bags of 10.</i> |
| A8061321 | 70017775  | Paper Pickup Roller Tire Only | AFICIO 550, AFICIO 551, AFICIO 650, AFICIO 700, AFICIO 850, AFICIO 1050, AFICIO 1055, AFICIO 1060, AFICIO 1075, AFICIO 1085, AFICIO 1105, AFICIO 2090, AFICIO 2105 | <i>Priced per Tire, sold in Bags of 10.</i> |
| AF013005 | 70019799  | Bottom Plate Friction Pad Cork Type | AFICIO 550, AFICIO 551, AFICIO 650, AFICIO 700, AFICIO 850, AFICIO 1050, AFICIO 1055, AFICIO 1060, AFICIO 1075, AFICIO 1085, AFICIO 1105, AFICIO 2090, AFICIO 2105 | <i>Priced per Friction Pad, sold in Bags of 10.</i> |
| A8061295 | 70017521  | Paper Feed Belt | AFICIO 550, AFICIO 551, AFICIO 650, AFICIO 700, AFICIO 850, AFICIO 1050, AFICIO 1055, AFICIO 1060, AFICIO 1075, AFICIO 1085, AFICIO 1105, AFICIO 2090, AFICIO 2105, DF- 67 | |
| A6801671 | 70022888  | Separation Roller Tire Only | AFICIO 550, AFICIO 551, AFICIO 650, AFICIO 700, AFICIO 850, AFICIO 1050, AFICIO 1085, AFICIO 1105, DF- 67 | <i>Priced per Tire, sold in Bags of 10.</i> |
| AF031021 | 70632521  | Paper Feed Roller Tire Only | AFICIO 550, AFICIO 650, AFICIO 850, AFICIO 1050, FT 6645, FT 6655, FT 6665, FT 7650, FT 7660, FT 7670, FT 8980, FT 8982, RT- 31, RT- 34, RT- 36, RT- 37 | <i>Priced per Tire, sold in Bags of 10.</i> |
| AF032021 | 70632523  | Separation Roller Tire Only | AFICIO 550, AFICIO 650, AFICIO COLOR 5106, AFICIO COLOR 5206, FT 6645, FT 6655, FT 6665, FT 7650, FT 7660, FT 7670, FT 8980, FT 8982, NC 5006, PS- 500, RT- 31, RT- 34, RT- 36, RT- 37 | <i>Priced per Tire, sold in Bags of 10.</i> |
| AF030021 | 70632525  | Paper Pickup Roller Tire Only | AFICIO 550, AFICIO 650, AFICIO COLOR 5106, AFICIO COLOR 5206, FT 6645, FT 6655, FT 6665, FT 7650, FT 7660, FT 7670, FT 8980, FT 8982, NC 5006, RT- 31, RT- 34, RT- 36, RT- 37 | <i>Priced per Tire, sold in Bags of 10.</i> |
| AF030020 | 70012106  | Paper Pickup Roller Tire Only | AFICIO 550, AFICIO 650, AFICIO COLOR 5106, AFICIO COLOR 5206, FT 6645, FT 6655, FT 6665, FT 7650, FT 7660, FT 7670, FT 8980, FT 8982, NC 5006, RT- 33 | <i>Priced per Tire, sold in Bags of 10.</i> |
| AF031022 | 70012104  | Paper Feed Roller Tire Only | AFICIO 550, AFICIO 650, AFICIO COLOR 5106, AFICIO COLOR 5206, FT 6645, FT 6655, FT 6665, FT 7650, FT 7660, FT 7670, FT 8980, FT 8982, NC 5006, RT- 33 | <i>Priced per Tire, sold in Bags of 10.</i> |
| AF032023 | 70012105  | Separation Roller Tire Only | AFICIO 550, AFICIO 650, AFICIO COLOR 5106, AFICIO COLOR 5206, FT 6645, FT 6655, FT 6665, FT 7650, FT 7660, FT 7670, FT 8980, FT 8982, NC 5006, RT- 33 | <i>Priced per Tire, sold in Bags of 10.</i> |
| AF030040 | 70020064  | Paper Pickup Roller Tire Only | AFICIO 551, AFICIO 700, AFICIO 850, AFICIO 1050, AFICIO 1055, AFICIO 1085, AFICIO 1105, FT 7950, FT 7960, FT 7970 | <i>Priced per Tire, sold in Bags of 3.</i> |

For use in
Ricoh
Copiers













Central/Eastern Europe
Telephone: 31(0)183-696969
Fax: 31(0)183-629055
E-mail: order@edc.katun.com

| OEM PN | KATUN PN | DESCRIPTION | MODEL NO. | |
|----------------------|---|--|--|---|
| Feed/Delivery | | | | |
| AF031040 | 70020064  | Feed Roller Tire Only | AFICIO 551, AFICIO 700, AFICIO 850, AFICIO 1050, AFICIO 1055, AFICIO 1085, AFICIO 1105, FT 7950, FT 7960, FT 7970 | <i>Priced per Tire, sold in Bags of 3.</i> |
| AF032040 | 70021389  | Separation Roller Tire Only | AFICIO 551, AFICIO 700, AFICIO 850, AFICIO 1050, AFICIO 1055, AFICIO 1085, AFICIO 1105, FT 7950, FT 7960, FT 7970 | <i>Priced per Tire, sold in Bags of 3.</i> |
| AF030041 | 70020064  | Bypass Pickup Roller Tire Only | AFICIO 551, AFICIO 700, AFICIO 850, AFICIO 1050, AFICIO 1055, FT 7950, FT 7960, FT 7970, RT- 38, RT- 42 | <i>Priced per Tire, sold in Bags of 3.</i> |
| AF031041 | 70020064  | Bypass Paper Feed Roller Tire Only | AFICIO 551, AFICIO 700, AFICIO 850, AFICIO 1050, AFICIO 1055, FT 7950, FT 7960, FT 7970, RT- 38, RT- 42 | <i>Priced per Tire, sold in Bags of 3.</i> |
| AF032041 | 70021389  | Bypass Lower Separation Roller Tire Only | AFICIO 551, AFICIO 700, AFICIO 850, AFICIO 1050, AFICIO 1055, FT 7950, FT 7960, FT 7970, RT- 38, RT- 42 | <i>Priced per Tire, sold in Bags of 3.</i> |
| AF032025 | 70009692  | Separation Roller Tire Only | AFICIO COLOR 2003, AFICIO COLOR 2103, AFICIO COLOR 2203, AFICIO COLOR 3006, AFICIO COLOR 3506, AFICIO COLOR 4006, AFICIO COLOR 4106, AFICIO COLOR 4506, FT 4022, FT 4027, FT 4127, FT 4522, FT 4527, FT 4622, FT 4822, FT 5035, FT 5135, FT 5535, FT 5632, FT 5640, FT 5732, FT 5740, FT 5832, FT 5840 | <i>Priced per Tire, sold in Bags of 10.</i> |
| AF031025 | 70009692  | Paper Feed Roller Tire Only | AFICIO COLOR 2003, AFICIO COLOR 2103, AFICIO COLOR 2203, AFICIO COLOR 3006, AFICIO COLOR 3506, AFICIO COLOR 4006, AFICIO COLOR 4106, AFICIO COLOR 4506, FT 4022, FT 4027, FT 4127, FT 4527, FT 4622, FT 4822, FT 5035, FT 5135, FT 5535, FT 5632, FT 5640, FT 5740, FT 5840 | <i>Priced per Tire, sold in Bags of 10.</i> |
| AF013004 | 70016956  | Friction Pad Cork Type | AFICIO COLOR 2003, AFICIO COLOR 2103, AFICIO COLOR 2203, FT 4022, FT 4027, FT 4127, FT 4522, FT 4527 | |
| AF030024 | 70009692  | Paper Pickup Roller Tire Only | AFICIO COLOR 2003, AFICIO COLOR 2103, AFICIO COLOR 2203, FT 4022, FT 4027, FT 4127, FT 4522, FT 4527, FT 4622, FT 4822, FT 5035, FT 5135, FT 5535, FT 5632, FT 5640, FT 5732, FT 5740, FT 5832, FT 5840 | <i>Priced per Tire, sold in Bags of 10.</i> |
| 52152619 | 70011091  | Paper Feed Roller Tire Only | DS 320, FT 4227, FT 4427, FT 4430, FT 4470, FT 4480, FT 4490, FT 4727, FT 5000, FT 5010, FT 5233, FT 5433, FT 5520, FT 5560, FT 5733, AD- 500, PS- 110, PS- 140, PS- 210, PS- 250 | <i>Priced per Tire, sold in Bags of 10.</i> |
| AF033003 | 70010227  | Friction Pad Cork Type "Pad only" | DS 320, FT 4420, FT 4480, FT 4490, FT 5000, FT 5010, FT 5520, FT 5560, AD- 100, AD- 110, AD- 400, AD- 600 | <i>Priced per Friction Pad, sold in Bags of 10.</i> |





| OEM PN | KATUN PN | DESCRIPTION | MODEL NO. |
|----------------------|---|---|---|
| Feed/Delivery | | | |
| 52062605 | 70632327  | Separation Roller Tire Only Various Applications Duplex | DS 5330, FT 4215, FT 4220, FT 4222, FT 4415, FT 4418, FT 4421, NC 305, PS- 310, PS- 320 FT 5070, FT 5540, FT 5570, FT 5590, FT 6620, FT 6750 |
| | | | <i>Priced per Tire, sold in Bags of 10.</i> |
| AF031012 | 70010496  | Paper Feed Roller Tire Only | DS 5330, PS- 310, PS- 320 |
| | | | <i>Priced per Tire, sold in Bags of 10.</i> |
| 52162844 | 70010227  | Friction Pad Cork Type "Pad only" | FT 2050, FT 2070, FT 2260, FT 4430, FT 4470, FT 4480, FT 4490, FT 5000, FT 5010, FT 5520, M 100 |
| | | | <i>Priced per Friction Pad, sold in Bags of 10.</i> |
| AF030008 | 70014413  | Paper Pickup Roller Tire Only | FT 3013, FT 3113, FT 3213, FT 3313, FT 3413 |
| | | | <i>Priced per Tire, sold in Bags of 10.</i> |
| A2032632 | 70014413  | Paper Pickup Roller Tire Only | FT 3013, FT 3113, FT 3213, FT 3313, FT 3413, FT 3513, FT 3713 |
| | | | <i>Priced per Tire, sold in Bags of 10.</i> |
| AF030012 | 70014414  | Support Paper Pickup Roller Tire Only | FT 3013, FT 3213 |
| | | | <i>Priced per Tire, sold in Bags of 10.</i> |
| A2032635 | 70014414  | Support Paper Pickup Roller Tire Only | FT 3013, FT 3213, FT 3513, FT 3713 |
| | | | <i>Priced per Tire, sold in Bags of 10.</i> |
| 54472723 | 70632525  | Paper Pickup Roller Tire Only | FT 3020, FT 3050, FT 3060, FT 3320, FT 4460, FT 5050, FT 5070, FT 5540, FT 5550, FT 5570, FT 5580, FT 5590, FT 6620, FT 6750, FT 9101, NC 100, NC 8015, NC 8115, PS- 13, PS- 150, PS- 220, RT- 32 |
| | | | <i>Priced per Tire, sold in Bags of 10.</i> |
| 54472693 | 70632523  | Separation Roller Tire Only | FT 3020, FT 3050, FT 3060, FT 3320, FT 4460, FT 5050, FT 5070, FT 5540, FT 5550, FT 5570, FT 5580, FT 5590, FT 6620, FT 6750, M 10, NC 100, NC 8015, NC 8115, PS- 13, PS- 150, PS- 220 |
| | | | <i>Priced per Tire, sold in Bags of 10.</i> |
| 54472726 | 70009139  | Paper Feed Roller Tire Only | FT 3020, FT 3050, FT 3060, FT 3320, FT 5050, FT 5070, FT 5540, FT 5550, FT 5570, FT 5580, FT 5590, FT 6620, FT 6750, FT 9101, NC 100, NC 8015, NC 8115, PS- 13, PS- 150, PS- 220, RT- 32 |
| | | | <i>Priced per Tire, sold in Bags of 10.</i> |
| 54472726 | 70632521  | Paper Feed Roller Tire Only | FT 3020, FT 3050, FT 3060, FT 3320, FT 5050, FT 5070, FT 5540, FT 5550, FT 5570, FT 5580, FT 5590, FT 6620, FT 6750, FT 9101, NC 100, NC 8015, NC 8115, PS- 13, PS- 150, PS- 220, RT- 32 |
| | | | <i>Priced per Tire, sold in Bags of 10.</i> |

For use in
Ricoh
Copiers

Central/Eastern Europe
Telephone: 31(0)183-696969
Fax: 31(0)183-629055
E-mail: order@edc.katun.com

| OEM PN | KATUN PN | DESCRIPTION | MODEL NO. | |
|------------------------------------|---|---|---|---|
| Feed/Delivery | | | | |
| N/P/N | 70011126  | Feed Tire Replacement Kit Tire Only Kit Contains: • (1) Paper Feed Tire • (1) Separation Tire • (1) Paper Pickup Tire | FT 3020, FT 3050, FT 3060, FT 3320, FT 5050, FT 5070, FT 5540, FT 5550, FT 5570, FT 5580, FT 5590, FT 6620, FT 6750, NC 100, NC 8015, NC 8115, PS- 13, PS- 150, PS- 220, RT- 36, RT- 37 | |
| 54422637 | 70010227  | Friction Pad Cork Type "Pad only" | FT 4030, FT 4060, FT 4065, FT 4085 | <i>Priced per Friction Pad, sold in Bags of 10.</i> |
| AF030002 | 70010824  | Paper Pickup Roller Tire Only | FT 4215, FT 4220, FT 4222, FT 4415, FT 4418, FT 4421 | <i>Priced per Tire, sold in Bags of 10.</i> |
| AF031006 | 70010824  | Paper Feed Roller Tire Only | FT 4215, FT 4220, FT 4222, FT 4415, FT 4418, FT 4421 | <i>Priced per Tire, sold in Bags of 10.</i> |
| A0692820 | 70010227  | Friction Pad Assembly Cork Type "Pad only" | FT 4227, FT 4422, FT 4427, FT 4727, FT 5233, FT 5433, FT 5733 | <i>Priced per Friction Pad, sold in Bags of 10.</i> |
| AF031019 | 70010824  | Paper Feed Roller Tire Only | FT 4227, FT 4427, FT 4727, FT 5233, FT 5433, FT 5733 | <i>Priced per Tire, sold in Bags of 10.</i> |
| AF032019 | 70632523  | Separation Roller Tire Only | FT 4227, FT 4427, FT 4727, FT 5233, FT 5433, FT 5733 | <i>Priced per Tire, sold in Bags of 10.</i> |
| AF030019 | 70632525  | Paper Pickup Roller Tire Only | FT 4227, FT 4427, FT 4727, FT 5233, FT 5433, FT 5733, NC 8015 | <i>Priced per Tire, sold in Bags of 10.</i> |
| A0752599 | 70021584  | Torque Limiter | FT 4415, FT 4418, FT 4421 | |
| AF031002 | 70010496  | Paper Feed Roller Tire Only | FT 4460 | <i>Priced per Tire, sold in Bags of 10.</i> |
| AF030001 <i>Final Inventory</i> | 70014408  | Duplex Entrance Actuator Roller Tire Only | FT 5540, FT 5570, FT 5590, FT 6620, FT 6750 | <i>Priced per Tire, sold in Bags of 10.</i> |
| AF010003 | 70010496  | Duplex Paper Feed Roller Tire Only | FT 5540, FT 5570, FT 5590, FT 6620, FT 6750, NC 305, PS- 320 | <i>Priced per Tire, sold in Bags of 10.</i> |
| A0969501 | 70014031  | Duplex Separation Belt | FT 6645, FT 6655, FT 6665, FT 7650, FT 7660, FT 7670 | <i>Priced per Package, 3 Belts per Package.</i> |



| OEM PN | KATUN PN | DESCRIPTION | MODEL NO. | |
|----------------------|---|--|---|---|
| Feed/Delivery | | | | |
| AF032024 | 70013192  | Duplex Separation Tire Tire Only | FT 6645, FT 6655, FT 6665, FT 7650, FT 7660, FT 7670 | <i>Priced per Tire, sold in Bags of 5.</i> |
| AF030006 | 70010496  | Paper Pickup Roller Tire Only | FT 8780, FT 8880 | <i>Priced per Tire, sold in Bags of 10.</i> |
| AF030015 | 70010496  | Paper Pickup Roller Tire Only | FT 8780, FT 8880, RT- 30 | <i>Priced per Tire, sold in Bags of 10.</i> |
| 58942171 | 70010969  | Original Feed Roller | DF- 32, DF- 34, DF- 51, DF- 38/39 | |
| A4971170 | 70015219  | Friction Belt Old Style | DF- 40, DF- 41, DF- 52, DF- 53, DF- 54, DF- 56 | <i>Priced per Belt, sold in Bags of 10.</i> |
| A4221358 | 70013062  | Friction Belt | DF- 41, DF- 52, DF- 53, DF- 54, DF- 57, DF- 58 | |
| A6281241 | 70018137  | Original Pickup Roller Tire Only | DF- 43, DF- 65 | <i>Priced per Tire, sold in Bags of 10.</i> |
| A4971155 | 70012386  | Friction Belt | DF- 56 | |
| A3762096 | 70018496  | Belt Pressure Roller | DF- 60 | |
| A3769502 | 70011796  | Separation Belt | DF- 60 | <i>Priced per Package, 4 Belts per Package.</i> |
| A3761445 | 70014409  | Original Feed Roller Tire Only | DF- 60, DF- 62 | <i>Priced per Tire, sold in Bags of 10.</i> |
| A5481271 | 70014387  | Separation Roller Tire Only | DF- 61, DF- 64 | <i>Priced per Tire, sold in Bags of 10.</i> |
| A5481276 | 70022258  | Original Separation Belt | DF- 61, DF- 64 | |
| A6101485 | 70017000  | Original Separation Belt | DF- 62 | |
| A5481461 | 70023146  | Belt Pressure Roller | DF- 67 | |
| A6801851 | 70020160  | Original Pickup Roller Tire Only | DF- 67 | <i>Priced per Tire, sold in Bags of 10.</i> |
| A8592141 | 70022885  | Paper Feed Belt | DF- 68, DF- 69, DF- 71, DF- 72, DF- 75, DF- 78, DF- 79 | |





For use in
Ricoh
Copiers













Central/Eastern Europe
Telephone: 31(0)183-696969
Fax: 31(0)183-629055
E-mail: order@edc.katun.com

| OEM PN | KATUN PN | DESCRIPTION | MODEL NO. |
|-----------|-------------|-------------|--------------|
|-----------|-------------|-------------|--------------|

Feed/Delivery



















| | | | | |
|----------|---|--|---------|--|
| B3512126 | 70023390  | Paper Pickup Roller | DF- 70 | |
| AF031056 | 70016894  | Paper Feed Roller Tire Only Ribbed Tire | PS- 330 | <i>Priced per Tire, sold in Bags of 4.</i> |



| OEM PN | KATUN PN | DESCRIPTION | MODEL NO. |
|------------------------------------|---|--|---|
| Filters | | | |
| AA012079 | 70019199  | Dust Filter | AFICIO 400, AFICIO 401, AFICIO 500 |
| A2291262 | 70020920  | Optics Dust Filter | AFICIO 550, AFICIO 551, AFICIO 650, AFICIO 700 |
| AA012060 | 70014739  | Developer Filter | AFICIO 550, AFICIO 551, AFICIO 650, AFICIO 700, AFICIO 850, AFICIO 1050, AFICIO 1055, AFICIO 1060, AFICIO 1075, AFICIO 1085, AFICIO 1105, FT 6645, FT 6655, FT 6665, FT 7650, FT 7660, FT 7670, FT 7950, FT 7960, FT 7970 |
| A2291104 | 70021435  | Ozone Filter | AFICIO 550, AFICIO 650 |
| A2931104 | 70020975  | Ozone Filter | AFICIO 551, AFICIO 700 |
| AA012113 | 70020164  | Pressure Release Filter Center | AFICIO 850, AFICIO 1050, AFICIO 1085, AFICIO 1105, AFICIO 2090, AFICIO 2105 |
| AA012114 | 70020163  | Pressure Release Filter Front | AFICIO 850, AFICIO 1050, AFICIO 1085, AFICIO 1105, AFICIO 2090, AFICIO 2105 |
| AA010015 | 70010194  | Ozone Filter | FT 2050, FT 2070, FT 2260, FT 3113, FT 3313, FT 3413, FT 4220, FT 4222 |
| AA010072 | 70014795  | Ozone Filter | FT 3013, FT 3113, FT 3213, FT 3313, FT 3413, FT 4215, FT 4220, FT 4222, FT 4415, FT 4418, FT 4421 |
| A2043080 | 70019159  | Developer Filter | FT 4022, FT 4027, FT 4127, FT 4522, FT 4527, FT 4622, FT 4822, FT 5035, FT 5135, FT 5535, FT 5632, FT 5640, FT 5732, FT 5740, FT 5832, FT 5840 |
| AA010063 <i>Final Inventory</i> | 70010190  | Ozone Filter | FT 4227, FT 4427, FT 4727, FT 5233, FT 5433, FT 5733 |
| AA012059 | 70017778  | Dust Filter | FT 6645, FT 6655, FT 6665 |
| A0962103 | 70014453  | Ozone Filter Filter Only without Case | FT 6645, FT 6655, FT 6665, FT 7650, FT 7660, FT 7670, FT 7950, FT 7960, FT 7970 |



For use in
Ricoh
Copiers

Central/Eastern Europe
Telephone: 31(0)183-696969
Fax: 31(0)183-629055
E-mail: order@edc.katun.com

| OEM PN | KATUN PN | DESCRIPTION | MODEL NO. |
|-----------------------|---|---|---|
| Fuser Cleaning | | | |
| AE042009 | 70016076  | Fuser Cleaning Roller | AFICIO 200, AFICIO 250, AFICIO 400, AFICIO 401 |
| AE042029 | 70017948  | Fuser Cleaning Roller | AFICIO 220, AFICIO 270, AFICIO 340, AFICIO 350, AFICIO 450, AFICIO 1022, AFICIO 1027, AFICIO 2022, AFICIO 2027, AFICIO COLOR 3006, AFICIO COLOR 4006, AFICIO COLOR 4106 |
| AE042030 | 70016688  | Fuser Cleaning Roller | AFICIO 500, FT 4022, FT 4027, FT 4127, FT 4522, FT 4527, FT 4622, FT 4822, FT 5035, FT 5135, FT 5535, FT 5632, FT 5640, FT 5732, FT 5740, FT 5832, FT 5840 |
| AE042035 | 70016315  | Oil Supply Cleaning Roller | AFICIO 550, AFICIO 551, AFICIO 650, AFICIO 700, AFICIO 1055, FT 7650, FT 7660, FT 7670, FT 7950, FT 7960, FT 7970 |
| AE042023 | 70016068  | Lower Fuser Cleaning Roller | AFICIO 550, AFICIO 650, FT 6645, FT 6655, FT 6665, FT 7650, FT 7660, FT 7670, FT 7950, FT 7960, FT 7970 |
| A2294090 | 70016392  | Lower Fuser Cleaning Roller Assembly | AFICIO 550, AFICIO 650, FT 6645, FT 6665, FT 7650, FT 7660, FT 7670 |
| AE042020 | 70016315  | Oil Supply Cleaning Roller | AFICIO 550, AFICIO 650, FT 7650, FT 7660, FT 7670, FT 7950, FT 7960, FT 7970 |
| AE042036 | 70016068  | Lower Fuser Cleaning Roller | AFICIO 551, AFICIO 650, AFICIO 700, AFICIO 1055, FT 6645, FT 6655, FT 6665, FT 7650, FT 7660, FT 7670, FT 7950, FT 7960, FT 7970 |
| AE045031 | 70019624  | Oil Supply Roller | AFICIO 850, AFICIO 1050 |
| AE040039 | 70023032  | Oil Supply Cleaning Roller | AFICIO 850, AFICIO 1050, AFICIO 1085, AFICIO 1105, AFICIO 2090, AFICIO 2105 |
| AE042042 | 70018610  | Lower Fuser Cleaning Roller | AFICIO 850, AFICIO 1050, AFICIO 1085, AFICIO 1105, AFICIO 2090, AFICIO 2105 |
| AE042052 | 70023605  | Lower Fuser Cleaning Roller | AFICIO 1060, AFICIO 1075 |
| AE045047 | 70023288  | Cleaning Web | AFICIO 1085, AFICIO 1105, AFICIO 2090, AFICIO 2105 |
| A2594080 | 70018467  | Oil Supply Pad | AFICIO COLOR 3006, AFICIO COLOR 4006, AFICIO COLOR 4106 |
| 52154130 | 70147239  | Oil Supply Pad | DS 320, DS 5330, FT 4430, FT 4470, FT 4480, FT 4490, FT 5000, FT 5010, FT 5520, FT 5560 |
| AE045001 | 70147240  | Oil Supply Pad | FT 5540, FT 5550, FT 5570, FT 5580, FT 5590, FT 6620, FT 6750, NC 100, NC 305 |
| A0974261 | 70016392  | Lower Fuser Cleaning Roller Assembly | FT 6645, FT 6655 |
| AE040006 | 70012652  | Oil Supply Roller | FT 6645, FT 6655 |

Central/Eastern Europe
Telephone: 31(0)183-696969
Fax: 31(0)183-629055
E-mail: order@edc.katun.com

For use in
Ricoh
Copiers

| OEM PN | KATUN PN | DESCRIPTION | MODEL NO. |
|-----------------------|---|---|------------------------------------|
| Fuser Cleaning | | | |
| AE042007 | 70016347  | Upper Fuser Cleaning Roller | FT 6665 |
| AE040007 | 70011584  | Oil Supply Roller FIBRA™ II Enhanced fuser cleaning efficiency. | FT 8780, FT 8880, FT 8980, FT 8982 |
| A9432038 | 70147241  | Fuser Roller Cleaning Felt Assembly Felt Only | LR 1 |



*Priced per Felt,
sold in Packages of 10.*

For use in
Ricoh
Copiers

Central/Eastern Europe
Telephone: 31(0)183-696969
Fax: 31(0)183-629055
E-mail: order@edc.katun.com

| OEM PN | KATUN PN | DESCRIPTION | MODEL NO. |
|--------|----------|-------------|-----------|
|--------|----------|-------------|-----------|

Fuser Oil

| | | | | |
|----------|---|---|---|---|
| A2579100 | 70022278  | Silicone Fuser Oil 1000 ml / Bottle | AFICIO COLOR 2003, AFICIO COLOR 2103, AFICIO COLOR 2203, AFICIO COLOR 3006, AFICIO COLOR 3506, AFICIO COLOR 4006, AFICIO COLOR 4106, AFICIO COLOR 4506, AFICIO COLOR 5106, AFICIO COLOR 5206, AFICIO COLOR 6010, AFICIO COLOR 6110, AFICIO COLOR 6513, DS 320, DS 5330, FT 2050, FT 2070, FT 2260, FT 3020, FT 3050, FT 3060, FT 3320, FT 4030, FT 4060, FT 4065, FT 4085, FT 4420, FT 4430, FT 4460, FT 4470, FT 4480, FT 4490, FT 5000, FT 5010, FT 5050, FT 5070, FT 5520, FT 5540, FT 5550, FT 5560, FT 5570, FT 5580, FT 5590, FT 6080, FT 6085, FT 6620, FT 6750, FT 7060, FT 7770, FT 7870, FT 9101, FT 9105, M 100, NC 100, NC 305, NC 5006, NC 8015, NC 8115 | <i>Priced per Bottle, sold in Boxes of 6.</i> |
| A2579550 | 70022278  | Silicone Fuser Oil 1000 ml / Bottle | AFICIO COLOR 2003, AFICIO COLOR 2103, AFICIO COLOR 2203, AFICIO COLOR 3006, AFICIO COLOR 3506, AFICIO COLOR 4006, AFICIO COLOR 4106, AFICIO COLOR 4506, AFICIO COLOR 5106, AFICIO COLOR 5206, AFICIO COLOR 6010, AFICIO COLOR 6110, AFICIO COLOR 6513, DS 320, DS 5330, FT 2050, FT 2070, FT 2260, FT 3020, FT 3050, FT 3060, FT 3320, FT 4030, FT 4060, FT 4065, FT 4085, FT 4420, FT 4430, FT 4460, FT 4470, FT 4480, FT 4490, FT 5000, FT 5010, FT 5050, FT 5070, FT 5520, FT 5540, FT 5550, FT 5560, FT 5570, FT 5580, FT 5590, FT 6080, FT 6085, FT 6620, FT 6750, FT 7060, FT 7770, FT 7870, FT 9101, FT 9105, M 100, NC 100, NC 305, NC 5006, NC 8015, NC 8115 | <i>Priced per Bottle, sold in Boxes of 6.</i> |







| OEM PN | KATUN PN | DESCRIPTION | MODEL NO. |
|-----------|-------------|-------------|--------------|
|-----------|-------------|-------------|--------------|

Gears





| | | | |
|-------|---|--|---|
| N/P/N | 70021727  | Drum Unit Gear Kit Kit Contains: <ul style="list-style-type: none">• (3) Plastic Idler Gear• (1) Plastic Drive Gear• (1) Metal Gear w/Plastic Insert• (1) Important Product Information | AFICIO 220, AFICIO 270, AFICIO 1022, AFICIO 1027 |
|-------|---|--|---|

For use in
Ricoh
 Copiers

Central/Eastern Europe
 Telephone: 31(0)183-696969
 Fax: 31(0)183-629055
 E-mail: order@edc.katun.com



| OEM PN | KATUN PN | DESCRIPTION | MODEL NO. |
|-------------|---|---|--|
| Kits | | | |
| N/P/N | 70022264  | Photoconductor Unit Rebuild Kit Kit Contains: <ul style="list-style-type: none"> • (1) OPC Drum • (1) Drum Cleaning Blade • (1) Drum Unit Gear Kit • (1) Black Developer 1 OPC Kit per Master Carton | AFICIO 220, AFICIO 270 <i>Priced per OPC Kit, sold per OPC Kit.</i> |
| N/P/N | 70023020  | Photoconductor Unit Rebuild Kit Kit Contains: <ul style="list-style-type: none"> • (1) OPC Drum • (1) Drum Cleaning Blade 1 OPC Kit per Master Carton | AFICIO 220, AFICIO 270 <i>Priced per OPC Kit, sold per OPC Kit.</i> |
| N/P/N | 70018749  | 150K PM Kit Kit Contains: <ul style="list-style-type: none"> • (1) Cleaning Kit • (1) Lower Pressure Roller • (1) Drum Cleaning Blade Assembly • (1) Upper Fuser Roller • (1) Transfer Belt • (1) Transfer Belt Cleaning Blade • (1) Cleaning Pad • (1) Charge Roller • (2) Drum Picker Finger • (5) Picker Finger | AFICIO 340, AFICIO 350, AFICIO 450 |
| N/P/N | 70021208  | 150K PM Kit Without the Cleaning Kit Kit Contains: <ul style="list-style-type: none"> • (1) Lower Pressure Roller • (1) Drum Cleaning Blade Assembly • (1) Upper Fuser Roller • (1) Transfer Belt • (1) Transfer Belt Cleaning Blade • (1) Cleaning Pad • (1) Charge Roller • (2) Drum Picker Finger • (5) Picker Finger | AFICIO 340, AFICIO 350, AFICIO 450 |
| N/P/N | 70020136  | Paper Feed Roller Kit Tire Only For KD 1010 Kit Contains: <ul style="list-style-type: none"> • (1) Paper Pickup Tire • (1) Separation/Feed Tire • (1) Paper Feed Tire | AFICIO 340, AFICIO 350, AFICIO 450, AFICIO 1035, AFICIO 1045, AFICIO COLOR 3006, AFICIO COLOR 3506, PS- 360, PS- 380, PS- 390, PS- 420 |





| OEM PN | KATUN PN | DESCRIPTION | MODEL NO. |
|-------------|---|---|---|
| Kits | | | |
| N/P/N | 70018842  | 120K PM Kit Without the Cleaning Kit Kit Contains: <ul style="list-style-type: none"> • (1) Friction Pad B • (1) Charge Corona Grid • (1) Drum Cleaning Blade • (1) Belt Cleaning Blade • (1) Friction Pad • (1) Corona Wire • (1) Upper Fuser Roller • (2) Heat Insulating Sleeve • (1) Duplex Friction Pad • (1) Bottom Plate Friction Pad • (1) Paper Feed Roller | AFICIO 400, AFICIO 401, AFICIO 500 |
| PMA292300K | 70021647  | 300K PM Kit Kit Contains: <ul style="list-style-type: none"> • (1) Corona Wire • (1) Drum Cleaning Blade • (1) Charge Corona Grid • (1) Upper Picker Finger • (2) Drum Picker Finger • (1) Cleaning Kit • (1) Corona Wire Cleaner • (1) Upper Fuser Roller • (8) Paper Pickup Roller • (1) Optics Dust Filter • (1) Ozone Filter • (1) Ozone Filter • (4) Separation Roller • (1) Drum Cleaning Brush • (1) Paper Feed Tire • (1) Paper Feed Roller • (1) Paper Pickup Roller | AFICIO 551, AFICIO 700 |
| N/P/N | 70022268  | Photoconductor Unit Rebuild Kit Kit Contains: <ul style="list-style-type: none"> • (1) OPC Drum • (1) Drum Cleaning Blade • (1) Reusable Squeeze Bottle • (1) Drum Unit Gear Kit 1 OPC Kit per Master Carton | AFICIO 1022, AFICIO 1027, AFICIO 1032, AFICIO 2022, AFICIO 2027 <i>Priced per OPC Kit, sold per OPC Kit.</i> |
| N/P/N | 70011126  | Feed Tire Replacement Kit Tire Only Kit Contains: <ul style="list-style-type: none"> • (1) Paper Feed Tire • (1) Separation Tire • (1) Paper Pickup Tire | FT 3020, FT 3050, FT 3060, FT 3320, FT 5050, FT 5070, FT 5540, FT 5550, FT 5570, FT 5580, FT 5590, FT 6620, FT 6750, NC 100, NC 8015, NC 8115, PS- 13, PS- 150, PS- 220, RT- 36, RT- 37 |

For use in
Ricoh
 Copiers



Central/Eastern Europe
 Telephone: 31(0)183-696969
 Fax: 31(0)183-629055
 E-mail: order@edc.katun.com

| OEM PN | KATUN PN | DESCRIPTION | MODEL NO. |
|---------------------------------|---|---|--|
| Kits | | | |
| N/P/N <i>Final Inventory</i> | 70632570  | Convenience Kit Kit Contains: <ul style="list-style-type: none"> • (1) Oil Supply Pad • (1) Drum Cleaning Brush • (1) Drum Cleaning Blade • (2) Corona Wire Separation • (1) Corona Wire Charge • (2) Corona Wire IDC, ODC, STC, TC • (1) Corona Wire Transfer, Quenching • (2) Paper Feed Tire • (2) Separation Tire • (2) Paper Pickup Tire | FT 5540, FT 5550, FT 5570, FT 5580, FT 5590, FT 6620 |
| RDPT-0059B | 70016754  | 120K Maintenance Kit Kit Contains: <ul style="list-style-type: none"> • (1) Corona Wire • (1) Paper Feed Tire • (1) Separation Tire • (1) Paper Pickup Tire • (1) Drum Cleaning Blade • (1) Charge Corona Grid • (1) Developer Filter • (1) Fuser Cleaning Roller • (1) Fuser Cleaning Roller • (1) Belt Cleaning Blade • (1) Oil Supply Roller • (1) Air Filter | FT 6645, FT 6655 |
| N/P/N | 70018606  | 120K Maintenance Kit Kit Contains: <ul style="list-style-type: none"> • (1) Corona Wire • (1) Paper Feed Tire • (3) Separation Tire • (1) Paper Pickup Tire • (1) Drum Cleaning Blade • (1) Charge Corona Grid • (1) Developer Filter • (1) Fuser Cleaning Roller • (1) Fuser Cleaning Roller • (1) Transfer Belt Cleaning Blade • (1) Oil Supply Roller • (1) Air Filter | FT 6645, FT 6655 |











| OEM PN | KATUN PN | DESCRIPTION | MODEL NO. |
|-------------|---|---|---------------------------|
| Kits | | | |
| RDPT-0061C | 70016753  | 240K Maintenance Kit Kit Contains: <ul style="list-style-type: none"> • (1) Duplex Separation Tire • (3) Duplex Separation Belt • (5) Upper Picker Finger • (2) Drum Picker Finger • (1) Drum Cleaning Brush • (1) Corona Wire Cleaner • (1) Transfer Belt | FT 6645, FT 6655, FT 6665 |
| N/P/N | 70018841  | 120K PM Kit Without the Cleaning Kit Kit Contains: <ul style="list-style-type: none"> • (1) Paper Pickup Tire • (1) Corona Wire • (4) Separation Belt • (1) Paper Feed Tire • (3) Separation Tire • (1) Paper Pickup Tire • (1) Drum Cleaning Blade • (1) Charge Corona Grid • (1) Duplex Separation Tire • (3) Duplex Separation Belt • (1) Ozone Filter • (1) Developer Filter • (1) Lower Fuser Cleaning Roller • (1) Upper Fuser Cleaning Roller • (1) Fuser Cleaning Roller • (1) Transfer Belt Cleaning Blade • (1) Corona Wire Cleaner • (1) Oil Supply Roller | FT 6665 |
| PMA175120K | 70017605  | 120K PM Kit Kit Contains: <ul style="list-style-type: none"> • (1) Corona Wire • (3) Paper Feed Tire • (3) Separation Tire • (3) Paper Pickup Tire • (1) Drum Cleaning Blade • (1) Charge Corona Grid • (1) Duplex Separation Tire • (3) Duplex Separation Belt • (1) Developer Filter • (1) Lower Fuser Cleaning Roller • (1) Oil Supply Cleaning Roller • (1) Belt Cleaning Blade • (1) Cleaning Kit • (1) Oil Supply Roller • (1) Oil Supply Cleaning Blade | FT 7650, FT 7660, FT 7670 |

For use in
Ricoh
 Copiers

Central/Eastern Europe
 Telephone: 31(0)183-696969
 Fax: 31(0)183-629055
 E-mail: order@edc.katun.com







| OEM PN | KATUN PN | DESCRIPTION | MODEL NO. |
|-------------|---|--|---------------------------|
| Kits | | | |
| PMA175240K | 70017606  | 240K PM Kit Kit Contains: <ul style="list-style-type: none"> • (1) Charge Corona Grid • (1) Corona Wire Cleaner • (1) Ozone Filter • (1) Belt Cleaning Blade • (5) Upper Picker Finger • (3) Duplex Separation Belt • (1) Drum Cleaning Blade • (1) Transfer Belt • (1) Oil Supply Cleaning Blade • (1) Developer Filter • (1) Corona Wire • (1) Drum Picker Finger • (1) Drum Cleaning Brush • (1) Upper Fuser Roller • (1) Lower Pressure Roller • (2) Lower Fuser Roller Bearing • (1) Oil Supply Roller • (1) Oil Supply Cleaning Roller • (1) Lower Fuser Cleaning Roller • (3) Paper Pickup Tire • (3) Paper Feed Tire • (3) Separation Tire • (1) Duplex Separation Tire | FT 7650, FT 7660, FT 7670 |
| N/P/N | 70018839  | 120K PM Kit Without the Cleaning Kit Kit Contains: <ul style="list-style-type: none"> • (1) Corona Wire • (3) Paper Feed Tire • (3) Separation Tire • (3) Paper Pickup Tire • (1) Drum Cleaning Blade • (1) Charge Corona Grid • (1) Duplex Separation Tire • (3) Duplex Separation Belt • (1) Developer Filter • (1) Lower Fuser Cleaning Roller • (1) Oil Supply Cleaning Roller • (1) Transfer Belt Cleaning Blade • (1) Oil Supply Roller • (1) Oil Supply Cleaning Blade | FT 7650, FT 7660, FT 7670 |



| OEM PN | KATUN PN | DESCRIPTION | MODEL NO. |
|--------------|---|-----------------------------------|--|
| Lamps | | | |
| AX440150 | 70022854  | Heater Lamp 230V 650W | AFICIO 1035, AFICIO 1045 |
| AX440164 | 70022826  | Heater Lamp 230V 550W | AFICIO 1060, AFICIO 1075 |
| 52059507 | 70021111  | Heater Lamp 240V 960W | FT 2050, FT 2070, FT 2260, FT 4030, FT 4060, FT 4085, FT 5050, FT 5070 |
| 54425752 | 70021111  | Heater Lamp 240V 960W | FT 2050, FT 2070, FT 2260, FT 4030, FT 4060, FT 4085, FT 5050, FT 5070, M 100 |
| AX520024 | 70021219  | Exposure Lamp 180V 280W | FT 3013, FT 3213, FT 3513, FT 3713 |
| AX440014 | 70021084  | Heater Lamp 220V 850W | FT 3320 |
| AX520025 | 70021163  | Exposure Lamp 85V 280W | FT 5035, FT 5135, FT 5535 |
| AX440049 | 70021085  | Heater Lamp 220V 830W | FT 5233, FT 5433, FT 5733 |
| AX520005 | 70021195  | Exposure Lamp 85V 160W | FT 5540, FT 5550, FT 5570, FT 5580, FT 5590, FT 6620, FT 6750 |
| AX520018 | 70021124  | Exposure Lamp 180V 280W | FT 6645, FT 6655 |

For use in
Ricoh
 Copiers

Central/Eastern Europe
 Telephone: 31(0)183-696969
 Fax: 31(0)183-629055
 E-mail: order@edc.katun.com

| OEM PN | KATUN PN | DESCRIPTION | MODEL NO. |
|----------------------------------|---|---|---|
| Memory Upgrades | | | |
| 410278 | 70018425  | Memory Upgrade Board- 48 MB Copier Memory Equivalent to Type 185 | AFICIO 150, AFICIO 180, AFICIO 220, AFICIO 270 |
| 000828MIU | 70020026  | Memory Upgrade Board- 32 MB Printer Memory Upgrade | AFICIO 150, AFICIO 180, AFICIO 1013, AFICIO 1013 F, AFICIO 1015, AFICIO 1018, AFICIO 1018 D, AFICIO 1022, AFICIO 1027 |
| 000829MIU | 70020027  | Memory Upgrade Board- 64 MB Printer Memory Upgrade | AFICIO 150, AFICIO 180, AFICIO 1013, AFICIO 1013 F, AFICIO 1015, AFICIO 1018, AFICIO 1018 D, AFICIO 1022, AFICIO 1027, AFICIO AP 3800 CMF |
| A2309352 | 70021045  | Memory Upgrade Board- 4 MB Flash Memory- Field Service Card | AFICIO 180, AFICIO 220, AFICIO 270, AFICIO 340, AFICIO 350, AFICIO 450, AFICIO 551, AFICIO 650, AFICIO 700, AFICIO 850, AFICIO 1050 |
| 410120 <i>Final Inventory</i> | 70017655  | Hard Drive Upgrade Kit Fax Feature Expander Equivalent to Type 460 | AFICIO 340, AFICIO 350, AFICIO 450 |
| 947MIU | 70020031  | Memory Upgrade Board- 32 MB Printer Memory Upgrade | AFICIO 551, AFICIO 700, AFICIO 850, AFICIO 1050 |

For current memory upgrade pricing, visit our on-line catalogue at www.katun.com or contact your customer service representative.





Central/Eastern Europe
Telephone: 31(0)183-696969
Fax: 31(0)183-629055
E-mail: order@edc.katun.com

For use in
Ricoh
Copiers







| OEM PN | KATUN PN | DESCRIPTION | MODEL NO. |
|-----------|-------------|-------------|--------------|
|-----------|-------------|-------------|--------------|







Miscellaneous

| | | | |
|----------|---|------------------------|--|
| AX210037 | 70021484  | Magnetic Clutch | AFICIO COLOR 5106, AFICIO COLOR 5206, FT 6645, FT 6655, FT 6665, FT 7650, FT 7660, FT 7670 |
| AX200107 | 70022980  | Magnetic Clutch | FT 4022, FT 4027, FT 4522, FT 4527, FT 4622, FT 4822, FT 5035, FT 5535 |

For use in
Ricoh
Copiers









Central/Eastern Europe
Telephone: 31(0)183-696969
Fax: 31(0)183-629055
E-mail: order@edc.katun.com

| OEM PN | KATUN PN | DESCRIPTION | MODEL NO. |
|-----------------------|---|--|--|
| Photoreceptors | | | |
| 209911 | 70015956 | OPC Drum Unit Original | AFICIO 200 |
| 410423 | 70018458 | OPC Drum Unit Original | AFICIO 220, AFICIO 270 |
| N/P/N | 70022264  | Photoconductor Unit Rebuild Kit Kit Contains: • (1) OPC Drum • (1) Drum Cleaning Blade • (1) Drum Unit Gear Kit • (1) Black Developer 1 OPC Kit per Master Carton | AFICIO 220, AFICIO 270 |
| | | | <i>Priced per OPC Kit, sold per OPC Kit.</i> |
| N/P/N | 70023020  | Photoconductor Unit Rebuild Kit Kit Contains: • (1) OPC Drum • (1) Drum Cleaning Blade 1 OPC Kit per Master Carton | AFICIO 220, AFICIO 270 |
| | | | <i>Priced per OPC Kit, sold per OPC Kit.</i> |
| 209890 | 70016414 | OPC Drum Unit Original | AFICIO 250 |
| A2309510 | 70019540  | OPC Drum 12 Drums per Master Carton | AFICIO 340, AFICIO 350, AFICIO 450, AFICIO 1035, AFICIO 1045, AFICIO 2035, AFICIO 2035 G, AFICIO 2045, AFICIO 2045 G |
| | | | <i>Priced per Drum, sold per Drum.</i> |
| A2309510 | 70018457 | OPC Drum Original | AFICIO 340, AFICIO 350, AFICIO 450, AFICIO 1035, AFICIO 1045, AFICIO 2035, AFICIO 2035 G, AFICIO 2045, AFICIO 2045 G |
| A1339510 | 70019726  | OPC Drum 6 Drums per Master Carton | AFICIO 400, AFICIO 401, AFICIO 500 |
| | | | <i>Priced per Drum, sold per Drum.</i> |
| A2949510 | 70018281  | OPC Drum 6 Drums per Master Carton | AFICIO 550, AFICIO 551, AFICIO 650, AFICIO 700, AFICIO 850, AFICIO 1050, AFICIO 1055, AFICIO 1085, AFICIO 1105, AFICIO 2090, AFICIO 2105 |
| | | | <i>Priced per Drum, sold per Drum.</i> |
| B0399510 | 70021670  | OPC Drum 50 Drums per Master Carton | AFICIO 1015, AFICIO 1018, AFICIO 1018 D, AFICIO 2015, AFICIO 2018, AFICIO 2018 D |
| | | | <i>Priced per Drum, sold per Drum.</i> |
| 411018 | 70023193 | OPC Drum Unit Original | AFICIO 1022, AFICIO 1027, AFICIO 1032, AFICIO 2022, AFICIO 2027 |

| OEM PN | KATUN PN | DESCRIPTION | MODEL NO. | |
|------------------------------------|---|--|---|--|
| Photoreceptors | | | | |
| N/P/N | 70022268  | Photoconductor Unit Rebuild Kit Kit Contains: • (1) OPC Drum • (1) Drum Cleaning Blade • (1) Reusable Squeeze Bottle • (1) Drum Unit Gear Kit 1 OPC Kit per Master Carton | AFICIO 1022, AFICIO 1027, AFICIO 1032, AFICIO 2022, AFICIO 2027 | <i>Priced per OPC Kit, sold per OPC Kit.</i> |
| B0649510 | 70018281  | OPC Drum 6 Drums per Master Carton | AFICIO 1060, AFICIO 1075 | <i>Priced per Drum, sold per Drum.</i> |
| A1669510 | 70016415 | OPC Drum Original | AFICIO COLOR 2003, AFICIO COLOR 2103, AFICIO COLOR 2203 | |
| 894716 | 70018138  | OPC Drum Assembly Equivalent to Type 100 20 Drums per Master Carton | AFICIO FX 10 | <i>Priced per Drum, sold per Drum.</i> |
| 889782 | 70018463 | Imaging Unit Original | FT 2012, FT 2212 | |
| A0779510 | 70010167  | OPC Drum 12 Drums per Master Carton | FT 3013, FT 3113, FT 3213, FT 3313, FT 3413, FT 3513, FT 3713 | <i>Priced per Drum, sold per Drum.</i> |
| A2199510 | 70016406 | OPC Drum Original | FT 3613, FT 3813, FT 4015, FT 4018, FT 4615, FT 4618 | |
| A2199510 | 70015760 | OPC Drum Access By Katun 20 Drums per Master Carton | FT 3613, FT 3813, FT 4015, FT 4018, FT 4615, FT 4618 | <i>Priced per Drum, sold per Drum.</i> |
| A1539510 | 70017029  | OPC Drum 12 Drums per Master Carton | FT 4022, FT 4027, FT 4127, FT 4522, FT 4527, FT 4622, FT 4822, FT 5035, FT 5135, FT 5535, FT 5632, FT 5640, FT 5732, FT 5740, FT 5832, FT 5840 | <i>Priced per Drum, sold per Drum.</i> |
| A1539510 | 70013358 | OPC Drum Original | FT 4022, FT 4027, FT 4127, FT 4522, FT 4527, FT 4622, FT 4822, FT 5035, FT 5135, FT 5535, FT 5632, FT 5640, FT 5732, FT 5740, FT 5832, FT 5840 | |
| 54429510 | 70502701  | As2Se3 Drum Tighter electrical tolerance and higher surface quality. 6 Drums per Master Carton | FT 4030, FT 4060, FT 4085, FT 4430, FT 4470 | <i>Priced per Drum, sold per Drum.</i> |
| 54429510 <i>Final Inventory</i> | 70017480  | As2Se3 Drum 6 Drums per Master Carton | FT 4030, FT 4060, FT 4085, FT 4430, FT 4470 | <i>Priced per Drum, sold per Drum.</i> |
| 54429510 | 70505335 | As2Se3 Drum Access By Katun 6 Drums per Master Carton | FT 4030, FT 4060, FT 4085, FT 4430, FT 4470 | <i>Priced per Drum, sold per Drum.</i> |

For use in
Ricoh
Copiers

Central/Eastern Europe
Telephone: 31(0)183-696969
Fax: 31(0)183-629055
E-mail: order@edc.katun.com

| OEM PN | KATUN PN | DESCRIPTION | MODEL NO. | |
|------------------------------------|---|---|--|--|
| Photoreceptors | | | | |
| 52059510 | 70502701  | As2Se3 Drum Tighter electrical tolerance and higher surface quality. 6 Drums per Master Carton | FT 4030, FT 4060, FT 4085, FT 4430, FT 4470, FT 4480, FT 4490, FT 5000, FT 5010, FT 5050, FT 5070, FT 5520, FT 5540, FT 5550, FT 5560, FT 5570, FT 5580, FT 5590, FT 6620, FT 6750 | <i>Priced per Drum, sold per Drum.</i> |
| 52059510 <i>Final Inventory</i> | 70017480  | As2Se3 Drum 6 Drums per Master Carton | FT 4030, FT 4060, FT 4085, FT 4430, FT 4470, FT 4480, FT 4490, FT 5000, FT 5010, FT 5050, FT 5070, FT 5520, FT 5540, FT 5550, FT 5560, FT 5570, FT 5580, FT 5590, FT 6620, FT 6750 | <i>Priced per Drum, sold per Drum.</i> |
| 52059510 | 70505335 | As2Se3 Drum Access By Katun 6 Drums per Master Carton | FT 4030, FT 4060, FT 4085, FT 4430, FT 4470, FT 4480, FT 4490, FT 5000, FT 5010, FT 5050, FT 5070, FT 5520, FT 5540, FT 5550, FT 5560, FT 5570, FT 5580, FT 5590, FT 6620, FT 6750 | <i>Priced per Drum, sold per Drum.</i> |
| A0699510 | 70018646  | OPC Drum Drum reduces noise in selected applications. 12 Drums per Master Carton | FT 4215, FT 4220, FT 4222, FT 4227, FT 4422, FT 4427, FT 4727, FT 5233, FT 5433, FT 5733 | <i>Priced per Drum, sold per Drum.</i> |
| A0699510 | 70014312  | OPC Drum 12 Drums per Master Carton | FT 4215, FT 4220, FT 4222, FT 4227, FT 4422, FT 4427, FT 4727, FT 5233, FT 5433, FT 5733 | <i>Priced per Drum, sold per Drum.</i> |
| A0699510 | 70013636 | OPC Drum Original | FT 4215, FT 4220, FT 4222, FT 4227, FT 4422, FT 4427, FT 4727, FT 5233, FT 5433, FT 5733 | |
| A0699510 | 70017128 | OPC Drum Access By Katun 12 Drums per Master Carton | FT 4215, FT 4220, FT 4222, FT 4227, FT 4422, FT 4427, FT 4727, FT 5233, FT 5433, FT 5733 | <i>Priced per Drum, sold per Drum.</i> |
| A0069510 | 70018646  | OPC Drum Drum reduces noise in selected applications. 12 Drums per Master Carton | FT 4415, FT 4418, FT 4421, FT 4460 | <i>Priced per Drum, sold per Drum.</i> |
| A0069510 | 70014312  | OPC Drum 12 Drums per Master Carton | FT 4415, FT 4418, FT 4421, FT 4460 | <i>Priced per Drum, sold per Drum.</i> |
| A0069510 | 70017128 | OPC Drum Access By Katun 12 Drums per Master Carton | FT 4415, FT 4418, FT 4421, FT 4460 | <i>Priced per Drum, sold per Drum.</i> |
| A0969510 | 70016933  | OPC Drum 12 Drums per Master Carton | FT 6645, FT 6655, FT 6665, FT 7650, FT 7660, FT 7670, FT 7950, FT 7960, FT 7970 | <i>Priced per Drum, sold per Drum.</i> |
| A2489510 | 70016933  | OPC Drum 12 Drums per Master Carton | FT 6645, FT 6655, FT 6665, FT 7650, FT 7660, FT 7670, FT 7950, FT 7960, FT 7970 | <i>Priced per Drum, sold per Drum.</i> |
| N/P/N | 70010710  | OPC Drum 20 Drums per Master Carton | LR 1 | <i>Priced per Drum, sold per Drum.</i> |



Katun Performance Product

© 2004 Katun Corporation

13 September 2004 For the most current product and pricing information, visit the Katun On-Line Catalog at www.katun.com.

Prices, terms and conditions are subject to change without notice.

Central/Eastern Europe
Telephone: 31(0)183-696969
Fax: 31(0)183-629055
E-mail: order@edc.katun.com

For use in
Ricoh
Copiers

| OEM PN | KATUN PN | DESCRIPTION | MODEL NO. |
|-----------|-------------|-------------|--------------|
|-----------|-------------|-------------|--------------|















Photoreceptors

| | | | |
|----------------------------------|----------|------------------------------|---------|
| 950055 <i>Final Inventory</i> | 70013487 | OPC Master Unit Original | M 10 |
| A1099510 | 70016439 | OPC Drum Original 40 K | NC 5006 |



For use in
Ricoh
Copiers

Central/Eastern Europe
Telephone: 31(0)183-696969
Fax: 31(0)183-629055
E-mail: order@edc.katun.com

| OEM PN | KATUN PN | DESCRIPTION | MODEL NO. | |
|-----------------------|---|----------------------------|---|---|
| Picker Fingers | | | | |
| AE044022 | 70017588  | Picker Finger | AFICIO 340, AFICIO 350, AFICIO 450 | <i>Priced per Picker Finger, sold in Boxes of 5.</i> |
| AE044028 | 70017588  | Upper Picker Finger | AFICIO 340, AFICIO 350, AFICIO 450 | <i>Priced per Picker Finger, sold in Boxes of 5.</i> |
| AD025021 | 70018635  | Drum Picker Finger | AFICIO 340, AFICIO 350, AFICIO 450, AFICIO 1035, AFICIO 1045 | <i>Priced per Picker Finger, sold in Boxes of 6.</i> |
| AD025020 | 70015660  | Drum Picker Finger | AFICIO 400, AFICIO 401, AFICIO 500 | <i>Priced per Picker Finger, sold in Packages of 6.</i> |
| AE044019 | 70015257  | Upper Picker Finger | AFICIO 400, AFICIO 401, AFICIO 500, AFICIO 551, AFICIO 700, FT 4022, FT 4027, FT 4127, FT 4522, FT 4527, FT 4622, FT 4822, FT 5035, FT 5135, FT 5535, FT 5632, FT 5640, FT 5732, FT 5740, FT 5832, FT 5840, FT 7950, FT 7960, FT 7970 | <i>Priced per Set, 5 Picker Fingers per Set.</i> |
| A0969500 | 70015257  | Upper Picker Finger | AFICIO 550, AFICIO 650, FT 6645, FT 6655, FT 6665, FT 7650, FT 7660, FT 7670 | <i>Priced per Set, 5 Picker Fingers per Set.</i> |
| AD025018 | 70015660  | Drum Picker Finger | AFICIO 550, AFICIO 650, FT 6645, FT 6655, FT 6665, FT 7650, FT 7660, FT 7670, FT 7950, FT 7960, FT 7970 | <i>Priced per Picker Finger, sold in Packages of 6.</i> |
| AD025022 | 70015660  | Drum Picker Finger | AFICIO 551, AFICIO 700, AFICIO 850, AFICIO 1050, AFICIO 1055, AFICIO 1085, AFICIO 1105, AFICIO 2090, AFICIO 2105 | <i>Priced per Picker Finger, sold in Packages of 6.</i> |
| AD025019 | 70015662  | Drum Picker Finger | FT 4022, FT 4027, FT 4127, FT 4522, FT 4527, FT 4622, FT 4822, FT 5035, FT 5135, FT 5535, FT 5632, FT 5640, FT 5732, FT 5740, FT 5832, FT 5840 | <i>Priced per Picker Finger, sold in Bags of 6.</i> |
| 54429006 | 70012859  | Upper Picker Finger | FT 4030, FT 4060, FT 4065, FT 4085, FT 4420, FT 5050, FT 5070 | <i>Priced per Set, 6 Picker Fingers per Set.</i> |
| A0069002 | 70012822  | Picker Finger | FT 4215, FT 4220, FT 4222, FT 4227, FT 4415, FT 4418, FT 4421, FT 4427, FT 4460, FT 4727, FT 5233, FT 5433, FT 5733 | <i>Priced per Set, 5 Picker Fingers per Set.</i> |
| 52159002 | 70012859  | Upper Picker Finger | FT 4430, FT 4470, FT 4480, FT 4490, FT 5000, FT 5010, FT 5520 | <i>Priced per Set, 6 Picker Fingers per Set.</i> |
| A0079005 | 70242357  | Picker Finger | FT 5540, FT 5550, FT 5570, FT 5580, FT 5590, FT 6620, FT 6750 | <i>Priced per Set, 6 Picker Fingers per Set.</i> |
| A9433122 | 70013734  | Upper Picker Finger | LR 1 | <i>Priced per Picker Finger, sold in Bags of 5.</i> |



Katun Performance Product

© 2004 Katun Corporation

Central/Eastern Europe
Telephone: 31(0)183-696969
Fax: 31(0)183-629055
E-mail: order@edc.katun.com















For use in
Ricoh
Copiers

| OEM PN | KATUN PN | DESCRIPTION | MODEL NO. |
|-----------------------|---|---------------|--------------|
| Picker Fingers | | | |
| A7150079 | 70013182  | Picker Finger | M 60 |

*Priced per Picker Finger,
sold in Bags of 10.*

For use in
Ricoh
Copiers















Central/Eastern Europe
Telephone: 31(0)183-696969
Fax: 31(0)183-629055
E-mail: order@edc.katun.com

| OEM PN | KATUN PN | DESCRIPTION | MODEL NO. |
|----------------------------|---|--|---|
| Rollers, Fuser/Heat | | | |
| AE011061 | 70022311  | Upper Fuser Roller | AFICIO 120, AFICIO 1013, AFICIO 1013 F |
| A2504110 | 70018470  | Upper Fuser Roller TRITON™ II | AFICIO 150, AFICIO 180 |
| A2504111 | 70018470  | Upper Fuser Roller TRITON™ II | AFICIO 150, AFICIO 180 |
| G0204170 | 70023404  | Upper Fuser Roller TRITON BLUE™ | AFICIO 200 |
| G0204170 | 70015917 | Upper Fuser Roller Access By Katun | AFICIO 200 |
| AE011048 | 70018752  | Upper Fuser Roller TRITON™ II | AFICIO 220, AFICIO 270 |
| A2244170 | 70017529  | Upper Fuser Roller TRITON™ II Improved Toner Release Characteristics | AFICIO 250 |
| AE011041 | 70017530  | Upper Fuser Roller TRITON™ II Improved Toner Release Characteristics | AFICIO 340, AFICIO 350, AFICIO 450 |
| AE011041 | 70016692 | Upper Fuser Roller Access By Katun | AFICIO 340, AFICIO 350, AFICIO 450 |
| AE011059 | 70017530  | Upper Fuser Roller TRITON™ II Improved Toner Release Characteristics | AFICIO 340, AFICIO 350, AFICIO 450 |
| AE011036 | 70017531  | Upper Fuser Roller TRITON™ II Improved Toner Release Characteristics | AFICIO 400, AFICIO 401, AFICIO 500 |
| AE011044 | 70023107  | Upper Fuser Roller TRITON™ II | AFICIO 550, AFICIO 551, AFICIO 650, AFICIO 700 |
| AE011049 | 70023678  | Upper Fuser Roller TRITON BLUE™ | AFICIO 850, AFICIO 1050 |
| AE011049 | 70018916 | Upper Fuser Roller Access By Katun | AFICIO 850, AFICIO 1050 |
| AE011056 | 70023678  | Upper Fuser Roller TRITON BLUE™ | AFICIO 850, AFICIO 1050, AFICIO 1085, AFICIO 1105, AFICIO 2090, AFICIO 2105 |
| AE011056 | 70018916 | Upper Fuser Roller Access By Katun | AFICIO 850, AFICIO 1050, AFICIO 1085, AFICIO 1105, AFICIO 2090, AFICIO 2105 |
| AE011065 | 70023852  | Upper Fuser Roller TRITON BLUE™ | AFICIO 1015, AFICIO 1018, AFICIO 1018 D |
| AE011058 | 70023853  | Upper Fuser Roller TRITON BLUE™ | AFICIO 1022, AFICIO 1027, AFICIO 2022, AFICIO 2027 |
| AE011064 | 70021945  | Upper Fuser Roller For use only in the models listed | AFICIO 1035, AFICIO 1045 |



Katun Performance Product

© 2004 Katun Corporation

| OEM PN | KATUN PN | DESCRIPTION | MODEL NO. |
|----------------------------|---|--|--|
| Rollers, Fuser/Heat | | | |
| AE011071 | 70021945  | Upper Fuser Roller For use only in the models listed | AFICIO 1035, AFICIO 1045 |
| AE011069 | 70023246  | Upper Fuser Roller | AFICIO 1060, AFICIO 1075 |
| AE010024 | 70018756  | Upper Fuser Roller Silicone Based | AFICIO COLOR 2003, AFICIO COLOR 2103, AFICIO COLOR 2203 |
| AE010035 | 70018754  | Upper Fuser Roller Silicone Based | AFICIO COLOR 3006, AFICIO COLOR 4006, AFICIO COLOR 4106 |
| AE010018 | 70019178  | Upper Fuser Roller Silicone Based | AFICIO COLOR 5106, AFICIO COLOR 5206 |
| H5232110 | 70014324  | Upper Fuser Roller DURACON™ II | AFICIO FX 10 |
| N/P/N | 70014363  | Upper Fuser Roller Assembly ALUMANA™ Patented TEFLON® coating with reinforcing oxides extends life. Kit Contains: • (1) Upper Fuser Roller • (2) Upper Fuser Roller Bearing • (2) Heat Insulating Sleeve | DS 320, FT 4030, FT 4060, FT 4065, FT 4085, FT 4420, FT 4430, FT 4480, FT 5000, FT 5010, FT 5050, FT 5070, FT 5520, FT 5540, FT 5550, FT 5560, FT 5570, FT 5580, FT 5590, FT 6620, FT 6750 |
| AE011003 | 70014362  | Upper Fuser Roller ALUMANA™ Patented TEFLON® coating with reinforcing oxides extends life. | DS 320, FT 4430, FT 4470, FT 4480, FT 4490, FT 5000, FT 5010, FT 5520, FT 5560 |
| AE011003 | 70014847 | Upper Fuser Roller Access By Katun | DS 320, FT 4430, FT 4470, FT 4480, FT 4490, FT 5000, FT 5010, FT 5520, FT 5560 |
| AE011035 | 70013837  | Upper Fuser Roller TRITON™ II Improved Toner Release Characteristics | FT 2260, FT 4215, FT 4220, FT 4222, FT 4415, FT 4418, FT 4421, FT 4422 |
| AE011035 | 70014850 | Upper Fuser Roller Access By Katun | FT 2260, FT 4215, FT 4220, FT 4222, FT 4415, FT 4418, FT 4421, FT 4422 |
| AE011033 | 70011994  | Upper Fuser Roller DURACON™ II | FT 3013, FT 3113, FT 3213, FT 3313, FT 3413, FT 3513, FT 3713 |
| A0179525 | 70636746  | Upper Fuser Roller DURAPREM™ II | FT 3320 |
| A2984081 | 70015920  | Upper Fuser Roller OEM Type | FT 3613, FT 3813, FT 4615 |
| A2194081 | 70015920  | Upper Fuser Roller OEM Type | FT 4015 |
| A2454100 | 70015920  | Upper Fuser Roller OEM Type | FT 4018 |

For use in
Ricoh
Copiers

Central/Eastern Europe
Telephone: 31(0)183-696969
Fax: 31(0)183-629055
E-mail: order@edc.katun.com

| OEM PN | KATUN PN | DESCRIPTION | MODEL NO. |
|------------------------------------|---|---|--|
| Rollers, Fuser/Heat | | | |
| AE011024 | 70019794  | Upper Fuser Roller TRITON™ II Improved Toner Release Characteristics | FT 4022, FT 4027, FT 4127, FT 4522, FT 4527, FT 4622, FT 4822 |
| AE011024 | 70014792 | Upper Fuser Roller Access By Katun | FT 4022, FT 4027, FT 4127, FT 4522, FT 4527, FT 4622, FT 4822 |
| 52059004 | 70014362  | Upper Fuser Roller ALUMANA™ Patented TEFLON® coating with reinforcing oxides extends life. | FT 4030, FT 4060, FT 4065, FT 4085, FT 4420, FT 5050, FT 5070 |
| 52059004 | 70014847 | Upper Fuser Roller Access By Katun | FT 4030, FT 4060, FT 4065, FT 4085, FT 4420, FT 5050, FT 5070 |
| AE011002 | 70010637  | Upper Fuser Roller DURACON™ II | FT 4227, FT 4427, FT 4460, FT 4727, FT 5233, FT 5433, FT 5733 |
| AE011002 | 70014848 | Upper Fuser Roller Access By Katun | FT 4227, FT 4427, FT 4460, FT 4727, FT 5233, FT 5433, FT 5733 |
| A2994100 | 70015920  | Upper Fuser Roller OEM Type | FT 4618 |
| AE011027 | 70019793  | Upper Fuser Roller TRITON™ II Improved Toner Release Characteristics | FT 5035, FT 5135, FT 5535, FT 5632, FT 5732, FT 5832 |
| AE011027 | 70014791 | Upper Fuser Roller Access By Katun | FT 5035, FT 5135, FT 5535, FT 5632, FT 5732, FT 5832 |
| AE011001 | 70014362  | Upper Fuser Roller ALUMANA™ Patented TEFLON® coating with reinforcing oxides extends life. | FT 5540, FT 5550, FT 5570, FT 5580, FT 5590, FT 6620, FT 6750 |
| AE011001 | 70014847 | Upper Fuser Roller Access By Katun | FT 5540, FT 5550, FT 5570, FT 5580, FT 5590, FT 6620, FT 6750 |
| AE011045 | 70016079  | Upper Fuser Roller OEM Type | FT 5640, FT 5840 |
| 52194096 <i>Final Inventory</i> | 70010506  | Upper Fuser Roller Assembly ALUMANA™ Patented TEFLON® coating with reinforcing oxides extends life. Includes: • (2) Ball Bearing • (2) Fuser Roller Spacer • (2) Heat Insulating Sleeve | FT 6080, FT 6085, FT 7060, FT 7770, FT 7870 |
| AE011042 | 70012373  | Upper Fuser Roller ALUMANA™ Patented TEFLON® coating with reinforcing oxides extends life. | FT 6645, FT 6655, FT 6665, FT 7650, FT 7660, FT 7670, FT 7950, FT 7960, FT 7970 |
| AE011042 | 70014849 | Upper Fuser Roller Access By Katun | FT 6645, FT 6655, FT 6665, FT 7650, FT 7660, FT 7670, FT 7950, FT 7960, FT 7970 |
| AE011032 <i>Final Inventory</i> | 70011285  | Upper Fuser Roller ALUMANA™ Patented TEFLON® coating with reinforcing oxides extends life. | FT 8780, FT 8880 |























Central/Eastern Europe
Telephone: 31(0)183-696969
Fax: 31(0)183-629055
E-mail: order@edc.katun.com

For use in
Ricoh
Copiers

| OEM PN | KATUN PN | DESCRIPTION | MODEL NO. |
|------------------------------------|---|--|------------------|
| Rollers, Fuser/Heat | | | |
| AE011037 <i>Final Inventory</i> | 70011285  | Upper Fuser Roller ALUMANA™ Patented TEFLON® coating with reinforcing oxides extends life. | FT 8980, FT 8982 |
| A9433099 | 70636775  | Upper Fuser Roller DURAPREM™ II | LR 1 |

For use in
Ricoh
Copiers

Central/Eastern Europe
Telephone: 31(0)183-696969
Fax: 31(0)183-629055
E-mail: order@edc.katun.com

| OEM PN | KATUN PN | DESCRIPTION | MODEL NO. |
|--------------------------|---|---|---|
| Rollers, Pressure | | | |
| AE020107 | 70022954  | Lower Pressure Roller MICROSLEEVE™ | AFICIO 120, AFICIO 1013, AFICIO 1013 F |
| G0294120 | 70018515  | Lower Pressure Roller MICROSLEEVE™ | AFICIO 150, AFICIO 180 |
| G0204180 | 70016078  | Lower Pressure Roller MICROSLEEVE™ | AFICIO 200 |
| AE020086 | 70019886  | Lower Pressure Roller MICROSLEEVE™ | AFICIO 220, AFICIO 270 |
| G0204280 | 70016794  | Lower Pressure Roller | AFICIO 250 |
| AE020074 | 70017027  | Lower Pressure Roller MICROSLEEVE™ | AFICIO 340, AFICIO 350, AFICIO 450 |
| AE020055 | 70013738  | Lower Pressure Roller MICROSLEEVE™ | AFICIO 400, AFICIO 401 |
| AE020072 | 70013738  | Lower Pressure Roller MICROSLEEVE™ | AFICIO 500 |
| AE022078 | 70017593  | Lower Pressure Roller MICROSLEEVE™ | AFICIO 550, AFICIO 551, AFICIO 650, AFICIO 700, AFICIO 1055 |
| AE020087 | 70019876  | Lower Pressure Roller MICROSLEEVE™ | AFICIO 850, AFICIO 1050 |
| AE020100 | 70022556  | Lower Pressure Roller MICROSLEEVE™ | AFICIO 1015, AFICIO 1018, AFICIO 1018 D |
| AE020118 | 70022955  | Lower Pressure Roller MICROSLEEVE™ | AFICIO 1022, AFICIO 1027 |
| AE020108 | 70021633  | Lower Pressure Roller MICROSLEEVE™ | AFICIO 1035, AFICIO 1045 |
| AE020112 | 70023403  | Lower Pressure Roller MICROSLEEVE™ | AFICIO 1060, AFICIO 1075 |
| AE020066 | 70018755  | Lower Pressure Roller Silicone Based | AFICIO COLOR 2003, AFICIO COLOR 2103, AFICIO COLOR 2203 |
| AE020110 | 70018753  | Lower Pressure Roller Silicone Based | AFICIO COLOR 3006, AFICIO COLOR 4006, AFICIO COLOR 4106 |
| AE020088 | 70019179  | Lower Pressure Roller Silicone Based | AFICIO COLOR 5106, AFICIO COLOR 5206 |
| AE020019 | 70636838  | Lower Pressure Roller MICROSLEEVE™ | DS 320, FT 4430, FT 4470, FT 4490, FT 5540, FT 5550, FT 5560, FT 5570, FT 5580, FT 5590, FT 6620, FT 6750 |
| AE020024 | 70011075  | Lower Pressure Roller MICROSLEEVE™ | FT 3013, FT 3113, FT 3213, FT 3313, FT 3413, FT 3513, FT 3713 |
| AE020006 | 70010021  | Lower Pressure Roller MICROSLEEVE™ PFA Sleeve extends life. | FT 3320 |















Katun Performance Product

© 2004 Katun Corporation

13 September 2004 For the most current product and pricing information, visit the Katun On-Line Catalog at www.katun.com.

Prices, terms and conditions are subject to change without notice.

| OEM PN | KATUN PN | DESCRIPTION | MODEL NO. |
|------------------------------------|---|---------------------------------------|---|
| Rollers, Pressure | | | |
| A2984082 | 70016730  | Lower Pressure Roller | FT 3613, FT 3813, FT 4615 |
| A1904082 | 70016730  | Lower Pressure Roller | FT 4015 |
| AE020050 | 70013738  | Lower Pressure Roller MICROSLEEVE™ | FT 4022, FT 4027, FT 4127, FT 4522, FT 4527, FT 4622, FT 4822, FT 5035, FT 5135, FT 5535, FT 5632, FT 5640, FT 5732, FT 5740, FT 5832, FT 5840 |
| AE020016 | 70020957  | Lower Pressure Roller MICROSLEEVE™ | FT 4215, FT 4220, FT 4222, FT 4415, FT 4418, FT 4421, FT 4422 |
| AE020015 | 70021557  | Lower Pressure Roller MICROSLEEVE™ | FT 4480, FT 5000, FT 5010, FT 5520 |
| AE020030 | 70021558  | Lower Pressure Roller MICROSLEEVE™ | FT 5233, FT 5433, FT 5733 |
| AE020059 | 70018873  | Lower Pressure Roller MICROSLEEVE™ | FT 6645, FT 6655, FT 6665, FT 7650, FT 7660, FT 7670 |
| 52194621 | 70011053  | Lower Pressure Roller MICROSLEEVE™ | FT 7060, FT 7770 |
| AE020020 | 70011053  | Lower Pressure Roller MICROSLEEVE™ | FT 7870 |
| AE020078 | 70018873  | Lower Pressure Roller MICROSLEEVE™ | FT 7950, FT 7960, FT 7970 |
| AE020023 | 70011053  | Lower Pressure Roller MICROSLEEVE™ | FT 8780, FT 8880 |
| A9433100 <i>Final Inventory</i> | 70636778  | Lower Pressure Roller Foam Type | LR 1 |





For use in
Ricoh
 Copiers

Central/Eastern Europe
 Telephone: 31(0)183-696969
 Fax: 31(0)183-629055
 E-mail: order@edc.katun.com

| OEM PN | KATUN PN | DESCRIPTION | MODEL NO. |
|--------|----------|-------------|-----------|
|--------|----------|-------------|-----------|

Seals

| | | | | |
|----------|---|--------------------|--|--|
| AA152142 | 70011640  | V Ring | FT 5540 | <i>Priced per Seal, sold in Bags of 4.</i> |
| A0079006 | 70013733  | Cleaning Unit Seal | FT 5540, FT 5550, FT 5570, FT 5580, FT 5590, FT 6620, FT 6750 | |
| 52193326 | 70011640  | V Ring | FT 5840 | <i>Priced per Seal, sold in Bags of 4.</i> |



Central/Eastern Europe
Telephone: 31(0)183-696969
Fax: 31(0)183-629055
E-mail: order@edc.katun.com

For use in
Ricoh
Copiers





| OEM PN | KATUN PN | DESCRIPTION | MODEL NO. |
|-----------|-------------|-------------|--------------|
|-----------|-------------|-------------|--------------|

Thermal Control Devices





| | | | |
|----------|---|------------|------------------------|
| G0204185 | 70017282  | Thermistor | AFICIO 200, AFICIO 250 |
|----------|---|------------|------------------------|

For use in
Ricoh
Copiers

Central/Eastern Europe
Telephone: 31(0)183-696969
Fax: 31(0)183-629055
E-mail: order@edc.katun.com

| OEM PN | KATUN PN | DESCRIPTION | MODEL NO. | |
|--------------------------------|---|--|--|--|
| Toners/Toner Cartridges | | | | |
| 410303 | 70019846 | Black Toner Cartridge Original | AFICIO 150, AFICIO 180 | |
| 889843 | 70016070  | Black Toner 216 g / Cartridge Equivalent to Type 20D, 20DE, 20DI 6 Cartridges per Master Carton | AFICIO 200 | <i>Priced per Carton, 6 Cartridges per Carton.</i> |
| 889843 | 70015955 | Black Toner Original 216 g / Cartridge | AFICIO 200 | <i>Priced per Box, 6 Cartridges per Box.</i> |
| 887977 | 70020264  | Black Toner 360 g / Cartridge Equivalent to Type 2110D and 2210D 6 Cartridges per Master Carton | AFICIO 220, AFICIO 270 | <i>Priced per Carton, 6 Cartridges per Carton.</i> |
| 887977 | 70018471 | Black Toner Original 360 g / Cartridge | AFICIO 220, AFICIO 270 | <i>Priced per Box, 6 Cartridges per Box.</i> |
| 889614 | 70017099  | Black Toner 216 g / Cartridge Equivalent to Type 2105D, 2205D, 2305D 6 Cartridges per Master Carton | AFICIO 250 | <i>Priced per Carton, 6 Cartridges per Carton.</i> |
| 889614 | 70016417 | Black Toner Original 216 g / Cartridge | AFICIO 250 | <i>Priced per Box, 6 Cartridges per Box.</i> |
| 885149 | 70023140  | Black Toner 700 g / Cartridge Equivalent to Type 3100D, 3200D Robust thermal characteristics resolve short fuser life. Consistent electrical properties result in uniform image density throughout developer life. 1 Carton (4 Cartridges) per Master Carton | AFICIO 340, AFICIO 345, AFICIO 350, AFICIO 450 | <i>Priced per Cartridge, sold in Cartons of 4.</i> |
| 885137 | 70023140  | Black Toner 700 g / Cartridge Equivalent to Type 3100D, 3200D Robust thermal characteristics resolve short fuser life. Consistent electrical properties result in uniform image density throughout developer life. 1 Carton (4 Cartridges) per Master Carton | AFICIO 340, AFICIO 350, AFICIO 450 | <i>Priced per Cartridge, sold in Cartons of 4.</i> |
| 885137 | 70018468 | Black Toner Original 700 g / Cartridge | AFICIO 340, AFICIO 350, AFICIO 450 | <i>Priced per Box, 4 Cartridges per Box.</i> |
| 887690 | 70015957 | Black Toner Original 700 g / Cartridge | AFICIO 400, AFICIO 401, AFICIO 500 | <i>Priced per Box, 4 Cartridges per Box.</i> |









| OEM PN | KATUN PN | DESCRIPTION | MODEL NO. | |
|--------------------------------|---|---|---|--|
| Toners/Toner Cartridges | | | | |
| 887690 | 70019933 | Black Toner Access By Katun 700 g / Cartridge 1 Box (4 Cartridges) per Master Carton | AFICIO 400, AFICIO 401, AFICIO 500 | <i>Priced per Box, 4 Cartridges per Box.</i> |
| 885190 | 70023139  | Black Toner 1220 g / Cartridge Equivalent to Type 5100D, 5200D 1 Carton (4 Cartridges) per Master Carton | AFICIO 550, AFICIO 650 | <i>Priced per Cartridge, sold in Cartons of 4.</i> |
| 887995 | 70023200 | Black Toner Original 1220 g / Cartridge | AFICIO 551, AFICIO 700 | |
| 885258 | 70022843  | Black Toner 230 g / Cartridge Equivalent to Type 1150D, 1250D 1 Box (6 Cartridges) per Master Carton | AFICIO 1013, AFICIO 1013 F | <i>Priced per Cartridge, sold in Boxes of 6.</i> |
| 888087 | 70022051  | Black Toner 260 g / Cartridge Equivalent to Type 1140D, 1220D 1 Box (6 Cartridges) per Master Carton | AFICIO 1015, AFICIO 1018, AFICIO 1018 D, AFICIO 1113 | <i>Priced per Cartridge, sold in Boxes of 6.</i> |
| 888087 | 70021473 | Black Toner Original 260 g / Cartridge | AFICIO 1015, AFICIO 1018, AFICIO 1018 D, AFICIO 1113 | |
| 885266 | 70022976  | Black Toner 360 g / Cartridge Equivalent to Type 2120D, 2220D, 2320D 1 Box (6 Cartridges) per Master Carton | AFICIO 1022, AFICIO 1027, AFICIO 1032, AFICIO 2022, AFICIO 2027, AFICIO 2032 | <i>Priced per Cartridge, sold in Boxes of 6.</i> |
| 885266 | 70023192 | Black Toner Original | AFICIO 1022, AFICIO 1027, AFICIO 1032, AFICIO 2022, AFICIO 2027, AFICIO 2032 | |
| 885251 | 70021475 | Black Toner Original 500 g / Cartridge | AFICIO 1035, AFICIO 1045 | |
| 885274 | 70023036  | Black Toner 1220 g / Cartridge Equivalent to Type 6110D, 6210D 1 Box (4 Cartridges) per Master Carton | AFICIO 1060, AFICIO 1075 | <i>Priced per Cartridge, sold in Boxes of 4.</i> |
| 885321 | 70023858 | Black Toner Original | AFICIO 1224 C, AFICIO 1224 C S/P, AFICIO 1232 C, AFICIO 1232 C S/P | |
| 885322 | 70023860 | Yellow Toner Original | AFICIO 1224 C, AFICIO 1224 C S/P, AFICIO 1232 C, AFICIO 1232 C S/P | |
| 885323 | 70023862 | Magenta Toner Original | AFICIO 1224 C, AFICIO 1224 C S/P, AFICIO 1232 C, AFICIO 1232 C S/P | |
| 885324 | 70023859 | Cyan Toner Original | AFICIO 1224 C, AFICIO 1224 C S/P, AFICIO 1232 C, AFICIO 1232 C S/P | |
| 888182 | 70023867 | Black Toner Original | AFICIO 2035, AFICIO 2035 G, AFICIO 2045, AFICIO 2045 G | |

For use in
Ricoh
Copiers

Central/Eastern Europe
Telephone: 31(0)183-696969
Fax: 31(0)183-629055
E-mail: order@edc.katun.com

| OEM PN | KATUN PN | DESCRIPTION | MODEL NO. | |
|--------------------------------|----------|--|--|--|
| Toners/Toner Cartridges | | | | |
| 888035 | 70022744 | Yellow Toner Cartridge Original 270 g / Cartridge | AFICIO AP 3800 CMF | |
| 888036 | 70022742 | Magenta Toner Cartridge Original 270 g / Cartridge | AFICIO AP 3800 CMF | |
| 888037 | 70022743 | Cyan Toner Cartridge Original 270 g / Cartridge | AFICIO AP 3800 CMF | |
| 889763 | 70016444 | Black Toner Original 300 g / Cartridge | AFICIO COLOR 2003, AFICIO COLOR 2103, AFICIO COLOR 2203 | <i>Priced per Box, 6 Cartridges per Box.</i> |
| 889764 | 70016443 | Yellow Toner Original 100 g / Cartridge | AFICIO COLOR 2003, AFICIO COLOR 2103, AFICIO COLOR 2203 | <i>Priced per Box, 6 Cartridges per Box.</i> |
| 889765 | 70016442 | Magenta Toner Original 100 g / Cartridge | AFICIO COLOR 2003, AFICIO COLOR 2103, AFICIO COLOR 2203 | <i>Priced per Box, 6 Cartridges per Box.</i> |
| 889766 | 70016441 | Cyan Toner Original 100 g / Cartridge | AFICIO COLOR 2003, AFICIO COLOR 2103, AFICIO COLOR 2203 | <i>Priced per Box, 6 Cartridges per Box.</i> |
| 887813 | 70018472 | Black Toner Original 340 g / Cartridge | AFICIO COLOR 5106, AFICIO COLOR 5206, NC 5006, NC 8115 | <i>Priced per Box, 4 Cartridges per Box.</i> |
| 887814 | 70018473 | Yellow Toner Original 340 g / Cartridge | AFICIO COLOR 5106, AFICIO COLOR 5206, NC 5006, NC 8115 | <i>Priced per Box, 4 Cartridges per Box.</i> |
| 887815 | 70018474 | Magenta Toner Original 340 g / Cartridge | AFICIO COLOR 5106, AFICIO COLOR 5206, NC 5006, NC 8115 | <i>Priced per Box, 4 Cartridges per Box.</i> |
| 887816 | 70018475 | Cyan Toner Original 340 g / Cartridge | AFICIO COLOR 5106, AFICIO COLOR 5206, NC 5006, NC 8115 | <i>Priced per Box, 4 Cartridges per Box.</i> |
| 339588 | 70017076 | Black Toner Cartridge Original 1250 g / Cartridge | AFICIO FX 10 | <i>Priced per Box, 4 Cartridges per Box.</i> |
| 887655 | 70807802 |  Black Toner 300 g / Cartridge Equivalent to Type 5010 4 Cartridges per Master Carton | DS 320, FT 4430, FT 4470, FT 4480, FT 4490, FT 5000, FT 5010, FT 5520, FT 5560 | <i>Priced per Carton, 4 Cartridges per Carton.</i> |
| 888078 | 70021652 | Black Toner Original 140 g / Cartridge | FT 1008, FT 1208 | |



| OEM PN | KATUN PN | DESCRIPTION | MODEL NO. |
|--------------------------------|---|--|--|
| Toners/Toner Cartridges | | | |
| 889776 | 70016440 | Black Toner Original 91 g / Cartridge | FT 2012, FT 2212 |
| 887661 | 70011529  | Black Toner 170 g / Cartridge Equivalent to Type 2000, 2050 4 Cartridges per Master Carton | FT 2050, FT 2070, FT 2260, M 100 |
| 887631 | 70019957  | Black Toner 320 g / Cartridge Type 320 8 Cartridges per Master Carton | FT 3013, FT 3213, FT 3513, FT 3713 |
| 887631 | 70013904 | Black Toner Original 320 g / Cartridge | FT 3013, FT 3213, FT 3513, FT 3713 |
| 887612 | 70012391  | Black Toner 320 g / Cartridge Equivalent to Type 310, 310E 8 Cartridges per Master Carton | FT 3113, FT 3313, FT 3413 |
| 887612 | 70013352 | Black Toner Original 320 g / Cartridge | FT 3113, FT 3313, FT 3413 |
| 885122 | 70016069  | Black Toner 215 g / Cartridge Equivalent to Type 1105, 1205, 1305 6 Cartridges per Master Carton | FT 3613, FT 3813, FT 4015, FT 4018, FT 4615, FT 4618 |
| 889857 | 70016069  | Black Toner 215 g / Cartridge Equivalent to Type 1105, 1205, 1305 6 Cartridges per Master Carton | FT 3613, FT 3813, FT 4015, FT 4018, FT 4615, FT 4618 |
| 889857 | 70016364 | Black Toner Original 215 g / Cartridge | FT 3613, FT 3813, FT 4015, FT 4018, FT 4615, FT 4618 |
| 889657 | 70016069  | Black Toner 215 g / Cartridge Equivalent to Type 1105, 1205, 1305 6 Cartridges per Master Carton | FT 4015, FT 4018 |
| 889490 | 70016352  | Black Toner 415 g / Cartridge Equivalent to Type 450, 450E, 450I 8 Cartridges per Master Carton | FT 4022, FT 4027, FT 4127, FT 4522, FT 4527, FT 4622, FT 4822, FT 5035, FT 5135, FT 5535, FT 5632, FT 5640, FT 5732, FT 5740, FT 5832, FT 5840 |
| 889490 | 70013645 | Black Toner Original 415 g / Cartridge | FT 4022, FT 4027, FT 4127, FT 4522, FT 4527, FT 4622, FT 4822, FT 5035, FT 5135, FT 5535, FT 5632, FT 5640, FT 5732, FT 5740, FT 5832, FT 5840 |

*Priced per Carton,
4 Cartridges per Carton.*

*Priced per Carton,
2 Cartridges per Carton.*

*Priced per Box,
2 Cartridges per Box.*

*Priced per Carton,
2 Cartridges per Carton.*

*Priced per Box,
2 Cartridges per Box.*

*Priced per Carton,
6 Cartridges per Carton.*

*Priced per Carton,
6 Cartridges per Carton.*

*Priced per Box,
6 Cartridges per Box.*





*Priced per Carton,
6 Cartridges per Carton.*

*Priced per Carton,
2 Cartridges per Carton.*

*Priced per Box,
2 Cartridges per Box.*

For use in
Ricoh
Copiers

Central/Eastern Europe
Telephone: 31(0)183-696969
Fax: 31(0)183-629055
E-mail: order@edc.katun.com

| OEM PN | KATUN PN | DESCRIPTION | MODEL NO. | |
|----------------------------------|---|--|---|--|
| Toners/Toner Cartridges | | | | |
| 887610 | 70014824  | Black Toner 370 g / Cartridge Equivalent to Type 410 4 Cartridges per Master Carton | FT 4215, FT 4220, FT 4222, FT 4415, FT 4418, FT 4421 | <i>Priced per Carton, 4 Cartridges per Carton.</i> |
| 887610 | 70013321 | Black Toner Original 370 g / Cartridge | FT 4215, FT 4220, FT 4222, FT 4415, FT 4418, FT 4421 | <i>Priced per Box, 4 Cartridges per Box.</i> |
| 887616 | 70012389  | Black Toner 320 g / Cartridge Equivalent to Type 510 4 Cartridges per Master Carton | FT 4227, FT 4427, FT 4727, FT 5233, FT 5433, FT 5733 | <i>Priced per Carton, 4 Cartridges per Carton.</i> |
| 887622 | 70018812  | Black Toner 330 g / Cartridge Equivalent to Type 5000 6 Cartridges per Master Carton | FT 5050, FT 5070, FT 5540, FT 5550, FT 5570, FT 5580, FT 5590, FT 6620 | <i>Priced per Carton, 6 Cartridges per Carton.</i> |
| 889454 | 70016944  | Black Toner 1140 g / Cartridge Equivalent to Type 610 4 Cartridges per Master Carton | FT 6645, FT 6655, FT 6665, FT 7650, FT 7660, FT 7670 | <i>Priced per Carton, 4 Cartridges per Carton.</i> |
| 889454 | 70013442 | Black Toner Original 1140 g / Cartridge Type 620 | FT 6645, FT 6655, FT 6665, FT 7650, FT 7660, FT 7670 | <i>Priced per Box, 4 Cartridges per Box.</i> |
| 885195 | 70019847 | Black Toner Original 1160 g / Cartridge | FT 7950, FT 7960, FT 7970 | <i>Priced per Box, 4 Cartridges per Box.</i> |
| 887660 <i>Final Inventory</i> | 70013899 | Black Toner Original 100 g / Cartridge | M 10 | <i>Priced per Box, 4 Cartridges per Box.</i> |



General Information

Credit Terms and Ordering Information

Credit Terms

Standard credit terms are net-30-days from date of invoice. To open a net-30-day account, please contact the Katun Credit Department. Until your credit application is approved, orders will be shipped upon receipt of cash in advance or a confirmed, Sight Draft, or via C.O.D. (Nominal C.O.D. handling charges will apply.)

Katun offers a 3% cash-with-order (CWO) discount. Katun will calculate the 3% discount, promptly inform you of the total charges, and ship your order immediately upon receipt of your payment.

Place all orders with Katun (E.D.C.) B.V. via:

- **Telephone: 31(0) 183–696969**
- **Fax: 31(0) 183–629055**
- **E-mail: order@edc.katun.com**
- **Address:**

Katun (E.D.C.) B.V.
Edisonweg 44
4207 HG Gorinchem
The Netherlands

Reference Katun part numbers on all orders.

Prices are in Euro, EX WORKS Gorinchem, The Netherlands.

Katun business hours are from 8:30 to 17.00 hours.

Katun has a € 350 minimum order. A € 35 charge will be added to orders under the minimum.

Wire transfer funds to:

ABN–AMRO Bank
Daalsesingel 71
Postbus 2059
3500 GB Utrecht
The Netherlands
Account Number: 55 70 74 134
Swift I.D.: ABN ANL 2A
IBAN: NL51ABNA0557074134

General Shipping Information and Product Return Policies

Shipping and Handling

Katun can provide you with alternatives for shipping. We will attempt to select the most convenient and cost-effective carrier for you. However, if you have a preferred carrier, please inform your Katun Customer Service Representative.



Central/Eastern Europe

Telephone: 31(0)183-696969

Fax: 31(0)183-629055

E-mail: order@edc.katun.com

Hazardous material shipments will be billed accordingly. A nominal handling charge is incorporated into our shipping costs.

Product Return Policies

- Katun **must** preauthorize all returns. For return procedures and a return, contact the Customer Service Department at 31(0) 183–696969.
- Toner, toner cartridges, digital duplicator inks and masters, and thermal transfer ribbons with personalized labels cannot be returned to Katun for credit unless a valid warranty claim exists.
- Returns and refused shipments are subject to a minimum 10% restocking charge.
- With the exception of warranty claims, merchandise returned more than 90 days from the invoice date will not be accepted.
- Merchandise which has been written on, marked, relabeled, or placed in other than original Katun packaging will not be accepted.
- All warranty claims submitted to Katun *must* be accompanied by a completed Distributor Choice Warranty Claim Form (included in this catalog). Customers must indicate a warranty choice on the form:
 - (a) Technical Evaluation/ Replacement or technical Evaluation/ Credit: Ship the product and the completed form to:

Katun (E.D.C.) B.V.
Edisonweg 44
4207 HG
Gorinchem
The Netherlands
 - (b) Automatic Replacement: send the completed form to your customer service representative.



Allgemeine Hinweise

Zahlungsbedingungen und Bestellinformationen

Die übliche Zahlungsweise ist bar innerhalb von 30 Tagen ab Rechnungsdatum. Zur Eröffnung eines Kontos wenden Sie sich bitte an die Katun Kreditabteilung. Bis zur Gewährung Ihres Kredits erfolgt der Versand von Bestellungen bei Vorkasse oder bei Erhalt eines bestätigten, Sichtwechsel oder gegen Nachnahme (unter Berechnung einer geringen Nachnahmegebühr).

Katun gewährt 3 % Skonto für Barzahlung bei Bestellung. Katun wird den Skontobetrag errechnen, Ihnen den Gesamtbetrag mitteilen und Ihre Bestellung unverzüglich nach Erhalt Ihrer Zahlung zum Versand aufgeben.

Bitte richten Sie alle Bestellungen an Katun (E.D.C.) B.V. unter:

- **Telefon: 31 (0) 183–696969**
- **Fax: 31 (0) 183–629055**
- **E-mail: order@edc.katun.com**
- **Adresse:**

Katun (E.D.C.) B.V.
Edisonweg 44
NL-4207 HG Gorinchem
Niederlande

Bitte bei allen Bestellungen die Katun Artikelnummern angeben. Preise verstehen sich in Euro, ab Werk Gorinchem, Niederlande.

Katun Geschäftszeit ist 8.30 - 17.00 Uhr. Für alle Bestellungen gilt ein Mindestbestellwert von € 350. Bei Bestellungen unter dem Mindestbestellwert wird ein Zuschlag von €35 berechnet.

Bankverbindung:

ABN AMRO Bank
Daalsesingel 71
Postbus 2059
NL-3500 GB Utrecht
Niederlande
Kontonummer: 55 70 74 134
Bankleitzahl: ABN ANL 2A
IBAN: NL51ABNA0557074134

Versand und Warenrücksendung

Bearbeitung und Versand

Katun bietet verschiedene Versandmethoden an. Wir bemühen uns, die für Sie günstigste und praktischste Versandart zu wählen. Falls Sie eine bestimmte Versandart/Firma vorziehen, teilen Sie dies bitte Ihrem Katun Repräsentanten mit.



Central/Eastern Europe

Telephone: 31(0)183-696969

Fax: 31(0)183-629055

E-mail: order@edc.katun.com

Versandkosten für Gefahrgüter werden entsprechend berechnet. Eine geringe Bearbeitungsgebühr ist in unseren Versandgebühren enthalten.

Warenrücksendung

- Nur von Katun vorher genehmigte Waren- rücksendungen können bearbeitet werden. Bitte lassen Sie sich vom Kundendienst unter der Telefonnummer 31 (0) 183-696969 genaue Anweisungen geben.
- Bei Warenrücksendungen werden 10 % Rücknahmegebühren in Abzug gebracht.
- Toner, Drucker-/Faxkartuschen, Tinten für digitale Duplikatoren sowie Thermo-Transfer-Bänder mit Firmenetiketten sind vom Umtausch ausgeschlossen, es sei denn, es liegt ein Garantiefall vor.
- Ware, die nach Ablauf von 90 Tagen ab Rechnungsdatum zurückgeschickt wird, kann nicht zurückgenommen werden (mit Ausnahme von Reklamationen).
- Ware, deren Verpackung markiert, etikettiert oder beschriftet wurde, oder Ware ohne Originalverpackung kann nicht zurückgenommen werden.
- Alle Garantieansprüche müssen von einem ausgefüllten Händler -Garantieformular begleitet sein (Formular in diesem Katalog enthalten). Geben Sie Ihren Regulierungswunsch auf dem Formular an:
 - (a) Technische Bewertung/Ersatz oder Technische Bewertung/Gutschrift: schicken Sie das Produkt und das vollständig ausgefüllte Formular an:

Katun (E.D.C.) B.V.
Edisonweg 44
NL-4207 HG Gorinchem
Niederlande
 - (b) Ersatz ohne Bewertung: schicken Sie das vollständig ausgefüllte Formular an Ihren Ansprechpartner der Auftragsbearbeitung.

DISTRIBUTOR CHOICE WARRANTY CLAIM FORM

Please print all information. For prompt processing of your claim, please complete all sections. Your feedback is important to the ongoing improvement of Katun products. Thank you.

I. WARRANTY CHOICE

Please check one. See Section 2 on reverse side for additional information.

Technical Evaluation/Replacement Technical Evaluation/Credit Automatic Replacement

II. CUSTOMER INFORMATION

Customer Number: _____ Date Shipped: _____

Company Name: _____ Delivery Date: _____

Address: _____

City: _____ State/Province: _____

Country: _____ Postal Code: _____

Your Name: _____ Title: _____

III. PRODUCT INFORMATION

| Katun PN | Quantity | Description | Serial/Lot Number |
|----------|----------|-------------|-------------------|
| 1) _____ | _____ | _____ | _____ |
| 2) _____ | _____ | _____ | _____ |
| 3) _____ | _____ | _____ | _____ |
| 4) _____ | _____ | _____ | _____ |
| 5) _____ | _____ | _____ | _____ |

IV. DETAILED REASON(S) FOR CLAIM

Provide specific information for each product claimed, explaining the reason for claim in as much detail as possible. Include machine models, machine log information, and copy/print counts. **See Section 3 on reverse side for additional specific requirements for photoreceptors.**

- 1) _____
- 2) _____
- 3) _____
- 4) _____
- 5) _____

FOR KATUN USE ONLY

Product Warranty Claim No.: _____ Pieces: _____
Received By: _____ Date: _____

Central/Eastern Europe

Telephone: 31(0)183-696969

Fax: 31(0)183-629055

E-mail: order@edc.katun.com

PLEASE READ AND COMPLY WITH ALL THESE REQUIREMENTS TO EXPEDITE THE PROCESSING OF YOUR CLAIM.

1. General Instructions

A completed copy of this form must accompany all product warranty claims. Please indicate date of product delivery for determination of warranty coverage time period. *Your feedback is important to the ongoing improvement of Katun products. Please complete all sections on the reverse side.*

2. Distributor Choice Warranty Claim Options

Please indicate your choice of Technical Evaluation/Replacement, Technical Evaluation/Credit, or Automatic Replacement. **NOTE:** Automatic Replacement claims must be filed within 90 days of product delivery date, and must not exceed US\$500/€ 550.

If no choice is indicated:

- (a) If product is included with this form, this claim will be treated as Technical Evaluation/Replacement.
- (b) If no product is included with this form, and the claim is less than US\$500/€ 550, this claim will be treated as Automatic Replacement.
- (c) If no product is included with this form, and the claim is more than US\$500/€ 550, the claim is invalid.

3. Specific Requirements

If damage (for example, a chip or scratch on a photoreceptor) is noted "out-of-box," DO NOT INSTALL THE PRODUCT. No copy/print samples are required. Installing a product with out-of-box damage could void the warranty.

Include applicable copy/print samples with all claims. If a photoreceptor is suspected to be defective after machine installation, please attach to this form the copy/print samples indicated below. This will allow a thorough evaluation of the claim. Ensure that neither the form nor copy/print samples will contact the photoreceptor surface during shipment.

FOR PHOTORECEPTORS USED IN COPIERS, include:

- (a) Three "sky shot" (open platen; black) copies;
- (b) Three white copies; and
- (c) Three copies of a test pattern.

NOTE: If the defect is not visible on the copies indicated above, please attach three copies which clearly show the defect.

FOR PHOTORECEPTORS USED IN PRINTERS AND PLAIN PAPER FACSIMILES, include three prints which clearly show the defect.

IMPORTANT: The Katun product warranty does not cover damage by operator, technician, or machine (including rotational scratches, gouges, scuff marks, or line scratches).

4. Shipping Instructions

ALL PRODUCT RETURNS MUST BE PROPERLY PACKAGED. This includes packaging in the correct individual product box and in a second container with adequate protective packaging material. This is required by all carriers.

NOTE: Products damaged in transit to Katun due to inadequate packaging cannot be covered by the Katun product warranty, and will be returned.

Ship Technical Evaluation claims, freight prepaid, to the address specifically indicated for this purpose in the "General Information" section of the Katun On-Line Catalogue and current printed catalogues. Katun cannot accept responsibility for product warranty claims sent to any other address. **Send Automatic Replacement Claims to your Katun Customer Service Representative.**

HÄNDLER-GARANTIEFORMULAR

Das Formular bitte in Druckschrift ausfüllen. Um eine umgehende Bearbeitung Ihrer Reklamation zu ermöglichen, tragen Sie bitte alle Angaben ein.

Ihr Feedback trägt zur weiteren Verbesserung von Katun-Produkten bei. Vielen Dank.

I. REGULIERUNGSWUNSCH

Bitte nur einen ankreuzen. Weitere Informationen finden Sie in Abschnitt 2 auf der Rückseite.

Technische Bewertung/Ersatz Technische Bewertung/Gutschrift Ersatz ohne Bewertung

II. KUNDENINFORMATIONEN

Kunden-Nr.: _____ Versanddatum: _____

Firmenname: _____ Lieferdatum: _____

Straße: _____

Postleitzahl: _____ Ort: _____

Land: _____

Ihr Name: _____ Titel/Funktion: _____

III. PRODUKTINFORMATIONEN

| Katun-Artikel-Nr. | Menge | Bezeichnung | Serien-/Lotnummer |
|-------------------|-------|-------------|-------------------|
| 1) _____ | _____ | _____ | _____ |
| 2) _____ | _____ | _____ | _____ |
| 3) _____ | _____ | _____ | _____ |
| 4) _____ | _____ | _____ | _____ |
| 5) _____ | _____ | _____ | _____ |

IV. AUS WELCHEM GRUND REKLAMIEREN SIE DIE WARE?

Machen Sie bitte zu jedem reklamierten Artikel so ausführliche und genaue Angaben wie möglich. Des weiteren benötigen wir Angaben zum Gerätemodell, eine Kopie des Bordbuches sowie Informationen bezüglich der Anzahl der erstellten Kopien/Ausdrucke des Produktes. **Bitte beachten Sie Punkt 3 auf der Rückseite mit wichtigen Informationen zur Reklamation von Fotorezeptoren.**

1) _____

2) _____

3) _____

4) _____

5) _____

NUR FÜR DEN INTERNEN GEBRAUCH

Reklamations-Nr.: _____ Stückzahl: _____

Entgegengenommen von: _____ Eingangsdatum: _____



Central/Eastern Europe

Telephone: 31(0)183-696969

Fax: 31(0)183-629055

E-mail: order@edc.katun.com

BITTE BEACHTEN SIE FOLGENDE HINWEISE, UM DIE BEARBEITUNG IHRER REKLAMATION ZU BESCHLEUNIGEN.

1. Allgemeine Hinweise

Verwenden Sie diesen Mängelbericht bei allen Reklamationen. Geben Sie zur Bestimmung der Garantiefrist bitte das Lieferdatum des Produktes an. *Ihr Feedback trägt zur weiteren Verbesserung von Katun-Produkten bei. Bitte tragen Sie alle Angaben auf der Rückseite vollständig ein.*

2. Händler-Garantieoption

Geben Sie bitte Ihren Regulierungswunsch an (Technische Bewertung/Ersatz, Technische Bewertung/Gutschrift oder Ersatz ohne Bewertung.) **BITTE BEACHTEN:** Reklamationen ohne Bewertung müssen innerhalb von 90 Tagen nach dem Lieferdatum des Produktes geltend gemacht werden und dürfen einen Wert von USD 500/Euro 550 nicht überschreiten.

Wenn keine Wahl getroffen wurde:

- (a) Wenn diesem Formular das Produkt beigelegt wurde, wird diese Reklamation als Technische Bewertung/Ersatz bearbeitet.
- (b) Wenn diesem Formular kein Produkt beigelegt wurde und der Wert der Reklamation weniger als USD 500/ Euro 550 beträgt, wird diese Reklamation als Ersatz ohne Bewertung bearbeitet.
- (c) Wenn diesem Formular kein Produkt beigelegt wurde und der Wert der Reklamation mehr als USD 500/ Euro 550 beträgt, besteht kein Anspruch auf Reklamation.

3. Spezielle Anforderungen

Wenn Schäden (z.B. Splitter oder Kratzer an einem Fotorezeptor) bereits „beim Auspacken“ festgestellt werden, dann **INSTALLIEREN SIE DAS PRODUKT NICHT.** Testkopien sind nicht erforderlich. Die Installation eines Produktes mit bereits bestehendem Schaden könnte zum Erlöschen Ihrer Garantieansprüche führen.

Fügen Sie allen Reklamationen entsprechende Testkopien bei. Wenn ein Fotorezeptor nach der Installation einen Defekt aufzuweisen scheint, legen Sie diesem Formular bitte die nachstehend beschriebenen Testkopien bei, um eine genaue Beurteilung der Mängel zu ermöglichen. Das Formular sowie die Testkopien dürfen bei der Rücksendung auf keinen Fall mit der Oberfläche des Fotorezeptors in Berührung kommen.

FÜR FOTOREZEPTOREN, DIE IN KOPIERERN BENUTZT WURDEN, folgende Testkopien beilegen:

- (a) 3 schwarze Kopien (bei offener Vorlagenglas-Abdeckung),
- (b) 3 weiße Kopien und
- (c) 3 Testkopien (vom Testbogen).

BITTE BEACHTEN: Ist der Defekt auf diesen Mustern nicht sichtbar, legen Sie bitte 3 Kopien bei, auf denen er deutlich zu erkennen ist.

FÜR FOTOREZEPTOREN, DIE IN DRUCKERN UND NORMALPAPIER-FAXGERÄTEN BENUTZT WURDEN, legen Sie bitte 3 Kopien bei, auf denen der Defekt deutlich zu erkennen ist.

WICHTIG: Schäden, die durch falsche Bedienung des Endanwenders, durch den Techniker oder das Gerät verursacht wurden (d. h. umlaufende Kratzer, Streifen, Abrieb oder querlaufende Kratzer), sind von der Katun Qualitätsgarantie ausgeschlossen.

4. Versandrichtlinien

ALLE TEILE, DIE AN UNS ZURÜCKGESANDT WERDEN, MÜSSEN SACHGEMÄSS VERPACKT SEIN, d. h. in dem entsprechenden Einzelkarton und einem zweiten Karton mit entsprechendem Verpackungsmaterial. Dies betrifft jeglichen Transportweg!

BITTE BEACHTEN: Teile, die nicht sachgemäß verpackt werden und uns aus diesem Grunde defekt erreichen, sind von der Katun-Qualitätsgarantie ausgeschlossen und werden nicht angenommen.

Schicken Sie Ihre Reklamation zur technischen Bewertung (frachtfrei) an die für diese Zwecke im Katun-Online-Katalog und dem gültigen regulären Katalog unter den „allgemeinen Hinweisen“ angegebene Adresse. Katun übernimmt keinerlei Verantwortung für Reklamationen, die an eine andere Adresse als die oben genannte geschickt werden. **Schicken Sie Reklamation zum Ersatz ohne Bewertung an Ihren Katun-Ansprechpartner.**

