

## Katun Products for use in

**Toshiba**

## Table of Contents

	<i>Page</i>
<b>Copy Machine Equivalency List</b> .....	i
<b>Descriptions of Katun Product Brands and Technologies</b> .....	v
<b>Beschreibungen der Produktmarken und Technologien von Katun</b> .....	ix
<b>Personalized Product Agreement</b> .....	xiii
<b>Vereinbarung Über Bestellung Von Produkten Mit Ihrem Firmenetikett</b> .....	xv
<b>Bearings/Bushings</b> .....	1
<b>Belts</b> .....	5
<b>Blades/Brushes</b> .....	6
<b>Corona/Charge/Transfer</b> .....	9
<b>Developers</b> .....	14
<b>Feed/Delivery</b> .....	16
<b>Filters</b> .....	24
<b>Fuser Cleaning</b> .....	26
<b>Kits</b> .....	28
<b>Lamps</b> .....	37
<b>Memory Upgrades</b> .....	38
<b>Miscellaneous</b> .....	39
<b>Photoreceptors</b> .....	40
<b>Picker Fingers</b> .....	43
<b>Rollers, Fuser/Heat</b> .....	44
<b>Rollers, Pressure</b> .....	46
<b>Thermal Control Devices</b> .....	48
<b>Toners/Toner Cartridges</b> .....	49
<b>Waste Toner Containers</b> .....	53
<b>General Information</b> .....	I
<b>Allgemeine Hinweise</b> .....	III
<b>Distributor Choice Warranty Claim Form</b> .....	V
<b>HÄNDLER-GARANTIEFORMULAR</b> .....	VII





**Copy Machine Equivalency List**

**Central/Eastern Europe**  
 Telephone: 31(0)183-696969  
 Fax: 31(0)183-629055  
 E-mail: order@edc.katun.com

<b>Toshiba</b>	<b>Konica</b>	<b>Lanier Worldwide</b>	<b>Sharp</b>	<b>Xerox</b>
1210		6112		
1340		6613		
1350		6713		
1360		7213		
1370		7313		
2060		7320		
2310		6523		
2500		6425		
2510		6525		
2540		6625		
2550		6725		
2860		7328		
2870		7228		
3210		6432		
3220		6532		
3240		6632		
3550		6735		
3560		7335		
3850 D		6838 D		
4010		6540		
4550		6745		
4560		7345		
5010		6450		
5020		6550		
5540		6755		
5560		7355		
6550		6765		
6560		7365		
7550		6775		
7560		7375		
7650		6775		
7660		7375		
BD 2810		6110		
BD 3110		6010		
BD 3301		516		
BD 3503		545		
BD 3701		526		
BD 4111		536		
BD 4121		537		
BD 4130		536 B4		
BD 4140		537 B4		
BD 4501		546		
BD 4511		596		
BD 4515		566		
BD 4810		6015		
BD 5120		6020		
BD 5511		570		
BD 5610		6022		
BD 5620		6022 DF		
BD 5910		3022 E		
BD 7511		595		
BD 7610		6130		
BD 7720		6030		

## Copy Machine Equivalency List

Toshiba	Konica	Lanier Worldwide	Sharp	Xerox
BD 7811		576		
BD 7812		576 DF		
BD 7815		583		
BD 7816		583 DF		
BD 7910		6230		
BD 8411		6040		
BD 8412		6040 DF		
BD 8510		6242		
BD 8811		586		
BD 8812		586 DF		
BD 9100		6155		
BD 9110		6055		
BD 9230		6260		
BD 9240		6360		
DP 1250				212 DC
DP 1450				214 DC
DP 1570	7015			
DP 1570 F	7015			
DP 2460	7024			
DP 5570		5355		
DP 6570		5365		
DP 8070		5480		
e-STUDIO 12			AL 1000	WorkCentre XD 100
			AL 1200	WorkCentre XD 102
				WorkCentre XD 103 f
				WorkCentre XD 104
				WorkCentre XD 105 f
e-STUDIO 15			AR F 151	WorkCentre XD 120 f
e-STUDIO 16				WorkCentre Pro 16 fx
				WorkCentre Pro 416
				WorkCentre Pr 416 DC
				WorkCentre Pr 416 DE
				WorkCentre Pro 416 E
				WorkCentre Pro 416 P
				WorkCentre Pr 416 Pi
				WorkCentre Pro 416 S
e-STUDIO 20				WorkCentre Pr 416 Si
				WORKCENTRE PR 421 DE
				WorkCentre P 421 DEi
				WORKCENTRE PRO 421 E
				WorkCentre Pr 421 PI
e-STUDIO 55		5555		
e-STUDIO 65		5565		
e-STUDIO 80		5580		
E-STUDIO 120			AR 122 E	
			AR 122 E N	
			AR 122 EN	
E-STUDIO 150			AR 123 E	
			AR 153 E	
			AR 153 E N	
E-STUDIO 650			AR 651	
E-STUDIO 810			AR 810	
E-STUDIO 900		LD 090		

## Copy Machine Equivalency List

Central/Eastern Europe  
 Telephone: 31(0)183-696969  
 Fax: 31(0)183-629055  
 E-mail: order@edc.katun.com

Toshiba	Konica	Lanier Worldwide	Sharp	Xerox
E-STUDIO 1050		LD 0105		
FC 22		5722		
FC 22 i		5722 P		
ADU- 9050	AD- 305			
GD- 1100			AR- FX 3	
KD- 1001		SS- 23		
KD- 2001		SS- 25		
KD- 2002		SS- 50		
KD- 2004		SS- 35		
KD- 3005		SS- 45		
MD- 1		ADM- 40		
MD- 2		ADM- 30		
MD- 3		ADM- 42		
MD- 4		ADM- 230		
MG- 2		556		
MG- 3		559		
MG- 5		574		
MG- 9		S- 40		
MG- 11		S- 60		
MG- 2001		SF- 2050		
MG- 2002		S- 50		
MG- 2004		SF- 65		
MG- 2005		S- 65		
MG- 2007	ST- 212			
MG- 2007 A	ST- 212			
MG- 2008	ST- 213			
MG- 2008 A	ST- 213			
MG- 2011		MSF- 65		
MG- 2012		SF- 230		
MG- 2015		MSF- 45		
MG- 2501		S- 2550 -I		
MG- 2502		S- 2550 -II		
MJ- 1017			AR- FN 11	
MJ- 1018			AR- FN 12	
MJ- 7001			AR- CF 1	
MP- 1		558		
MP- 2		538		
		583 -LCC		
MP- 3		LCC- 40		
MP- 4		LCC- 30		
MP- 100		LCC- 32		
MP- 101		LCC- 42		
MP- 1501		LCC- 28		
MP- 4001		LCC- 45		
MP- 4003			AR- LC 4	
MR- 1		557		
MR- 2		573		
MR- 3		547		
MR- 4		ADF- 30		
MR- 2001		ADF- 23		
MR- 2002		ADF- 32		
MR- 2008		ADF- 28		
MR- 2013			AR- SP 3	

## Copy Machine Equivalency List

<b>Toshiba</b>	<b>Konica</b>	<b>Lanier Worldwide</b>	<b>Sharp</b>	<b>Xerox</b>
MR- 2014			AR- SP 5	
MR- 3001		RADF- 25		
MR- 3003		RADF- 40		
MR- 3004	DF- 307			
MR- 3006		RADF- 7345		
MR- 3006 A		RADF- 28		
MY- 4		SFB		
MY- 1005	MT- 101			
MY- 1019			AR- DE 9	
MY- 3001	PF- 304			



## Descriptions of Katun Product Brands and Technologies

### Katun Performance Products

Katun Performance is our complete line of office automation products that combine our highest quality level with consistent, reliable performance and competitive pricing - and provide excellent overall value.

Katun Performance products meet strict quality guidelines and have been 100% tested and approved according to the Katun 360° Certification process, which includes environmental testing, forward and reverse compatibility testing, model application testing, and component compatibility testing. In addition, all Katun Performance products are warranted to be free from functional defects in material and workmanship for one year and come with the highest level of Katun technical support.

To locate Katun Performance products, look for the Katun Performance icon  throughout this catalog.

### Access by Katun Products

Access by Katun is a line of selected products that address the unique pricing or product needs of specific markets. Access by Katun products provide market acceptable quality and market competitive pricing. The Access by Katun product line complements the Katun Performance line by providing a value proposition based primarily on specific market needs.

Access by Katun products come with a limited level of product support and a one-year warranty. Although Access by Katun products provide some price advantages, remember that Katun Performance products always provide excellent overall value.

### Original Products

Select OEM brand products that Katun offers to meet certain market needs

### Fuser Roller Coating Technologies

Minco Manufacturing, Inc., a wholly owned subsidiary of Katun Corporation, is a world-leading manufacturer of fuser rollers for use in plain paper copiers, facsimiles, and printers. The product development relationship between Katun, Minco, and DuPont, the exclusive manufacturer of genuine TEFLON<sup>®</sup> brand coatings, has produced numerous advanced fuser roller coating technologies, including:

**DURAPREM™II upper fuser rollers** are manufactured with a heat-resistant, nonstick TEFLON<sup>®</sup> brand coating that provides increased surface hardness for extended potential life. A proprietary finishing process produces an exceptionally smooth surface, which contributes to these rollers' excellent fusing performance and toner release in machines using negative-charge toner.

**DURACON™II upper fuser rollers** are manufactured with a heat-resistant, nonstick TEFLON<sup>®</sup> brand coating that includes patented conductive additives for static dissipation. These rollers provide excellent fusing performance, toner release, and long life, primarily in machines using positive-charge toner.

**ALUMANA™ upper fuser rollers** are manufactured with extremely hard, tough primer and midcoat layers for maximum resistance to wear and abrasion. The ceramic ALUMANA coating combines a DuPont-patented polymer blend with reinforcing oxides for enhanced durability. These heavy-duty rollers are specifically designed to meet the demands of hostile fuser station environments and higher-speed machines using either positive-charge or negative-charge toner.

**TRITON™II upper fuser rollers** are manufactured with an advanced TEFLON<sup>®</sup> brand coating that provides improved fusing performance and nonstick characteristics in comparison to conventional fluoropolymer coatings. Unique static-dissipative particulates within the TRITON II coating, together with enhanced manufacturing processes, contribute to these rollers' superior abrasion- resistance and excellent toner release. These rollers provide extended potential life in selected machines using either positive- charge or negative-charge toner.

## Central/Eastern Europe

Telephone: 31(0)183-696969

Fax: 31(0)183-629055

E-mail: [order@edc.katun.com](mailto:order@edc.katun.com)

**TRITON BLUE™ upper fuser rollers** deliver excellent performance for machine applications that are tough on fuser rollers. Manufactured with an advanced TEFLON® brand coating that provides improved fusing performance and nonstick characteristics in comparison to conventional fluoropolymer coatings, TRITON BLUE™ fuser rollers combine improved wear resistance with superior abrasion-resistance and excellent toner release.

**REVOLUTION™ upper fuser rollers** utilize a PFA sleeve coating that is more environmentally friendly than standard spray technology, while still achieving uniform coating thickness and even heat distribution. These fuser rollers provide proper fusing, excellent abrasion resistance and long life, even during extensive copy runs.

**TUF/SIL™ upper fuser rollers** are manufactured with a layer of silicone rubber that effectively regulates heat flow to the toner, plus an outermost layer that consists of a specially blended TEFLON® brand coating providing excellent toner release and abrasion-resistance. This combination ensures reduced toner offsetting and improved, more consistent copy quality under certain demanding machine usage conditions. These rollers provide a high-performance, cost-effective solution for selected machines required to consistently produce the best possible copy quality.

**MICROSLEEVE™ lower pressure rollers**, with nonstick PFA sleeves 50, 70, or 100 microns in thickness, provide excellent wear-resistance for improved copy quality over an extended life. A-Series MICROSLEEVE™ lower pressure rollers are designed specifically for machines utilizing lower fuser cleaning rollers. Their unique surface texture reduces toner buildup and improves cleaning efficiency within the fuser station.

All Katun fuser rollers are designed specifically for their intended applications and manufactured to exacting quality standards, ensuring their excellent performance and long life.

## Fuser Cleaning Roller Coating Technologies

Katun has introduced unique fuser cleaning roller technologies for machines requiring efficient removal and absorption of excess toner and contaminants, as well as continuous silicone oil lubrication of critical fuser station parts. For many machines, the ideal parts combination for achieving optimum copy quality and maximum parts life includes a specially designed Katun fuser cleaning roller.

**FIBRA™ fuser cleaning rollers** incorporate a uniform network of special fibers that aggressively remove excess toner and contaminants from the contacted surface. By efficiently depositing toner and contaminants beneath its outermost surface, the unique FIBRA network also helps maintain a continuous lubricative flow of silicone oil from the roller's internal tank to critical fuser station parts.

**FIBRA™ II fuser cleaning rollers** incorporate a unique configuration of highly heat-resistant fibers to greatly enhance cleaning performance, especially in hostile fuser station environments. Efficient absorption of excess toner and contaminants, together with continuous silicone oil lubrication of critical fuser station parts, effectively reduce parts and service expenses associated with the fuser station.

TEFLON® is a registered trademark of E.I. DuPont de Nemours and Company used under license by Katun Corporation.

### **Personalized Product Program**

Katun offers an extremely cost-effective way for office equipment dealers/distributors to ensure repeat business and strengthen relations with customers. The **Personalized Product program** enables dealers/distributors to provide high-quality Katun Performance imaging supplies (toner, fax and printer toner cartridges, digital duplicator inks and masters and thermal transfer ribbons) with their business name and /or logo, plus contact information, so end-users always know whom to call to reorder. For a one-time, nominal set-up fee, Katun designs and produces full-color labels to customer specifications and applies them to packaging at no extra charge. Only end-user-replaceable Katun Performance products are eligible under the program. Enrollment is simple and easy. Just complete the agreement form and submit it to your Katun sales representative or visit the [Personalized Products](#) page for more program and enrollment information.



## Beschreibungen der Produktmarken und Technologien von Katun

### Katun Performance-Produkte

Katun Performance ist unsere umfangreiche Produktreihe von Büromaschinenprodukten, die sich durch hohe Qualität sowie durch beständige, zuverlässige Leistung und attraktive Preise auszeichnen. Mit diesen Produkten soll der Nutzwert für den Kunden maximiert werden.

Katun Performance -Produkte erfüllen strenge Qualitätsstandards und wurden alle im Rahmen des 360° -Zertifizierungsverfahrens von Katun getestet und freigegeben. Die Produkte durchlaufen dabei Prüfungen der Umweltverträglichkeit, der Kompatibilität, der Modellanwendungen und der Komponentenkompatibilität. Darüber hinaus wird bei allen Katun Performance-Produkten ein Jahr lang gewährleistet, dass diese frei von funktionalen Material- und Verarbeitungsfehlern sind. Selbstverständlich steht Ihnen auch der hochwertige technische Support von Katun zur Verfügung.

**Um die Katun Performance-Produkte zu finden, halten Sie in diesem Katalog nach dem Namen Performance  und dem entsprechenden Symbol Ausschau.**

### Originalprodukte

Sie können verschiedene OEM-Produkte auswählen, die Katun aufgrund der Nachfrage auf dem Markt in sein Produktangebot aufgenommen hat.

### Beschichtungstechnologien für Heizwalzen

Minco Manufacturing Incorporated, eine hundertprozentige Tochtergesellschaft der Katun Corporation, ist einer der weltweit führenden Hersteller von Heizwalzen für Kopierer, Faxgeräte und Drucker. Die enge Zusammenarbeit zwischen Katun, Minco und DuPont, dem alleinigen Hersteller originaler TEFLON® - Beschichtungen, hat zur Entwicklung von zahlreichen neuartigen Beschichtungsmaterialien für Heizwalzen geführt:

**DURAPREM™ II** Heizwalzen sind mit einer temperaturbeständigen TEFLON® - Antihaf-Beschichtung ausgestattet und besitzen daher eine größere Oberflächenhärte für eine potenziell längere Lebensdauer. Die nach einem speziellen Finish-Verfahren hergestellte, außerordentlich glatte Walzenoberfläche bietet hervorragende Fixier- und Antihaf-Eigenschaften in Geräten mit negativ geladenem Toner.

**DURACON™ II** Heizwalzen sind mit einer temperaturbeständigen TEFLON® - Antihaf-Beschichtung ausgestattet, der patentierte, elektrisch leitfähige Inhaltsstoffe beigemischt sind, um das Ableiten von sich bildender statischer Ladung zu ermöglichen. Diese Heizwalzen zeichnen sich durch ihre hervorragenden Fixier- und Antihaf-Eigenschaften sowie eine lange Nutzungsdauer aus, besonders in Geräten mit positiv geladenem Toner.

**ALUMANA™** Heizwalzen besitzen eine äußerst harte, widerstandsfähige Grund- und Zwischenschicht für eine höchstmögliche Verschleißfestigkeit und Haltbarkeit. Die ALUMANA Keramiksicht beinhaltet eine patentierte Polymer-Mischung von DuPont mit Verstärkungsoxiden für eine erhöhte Widerstandsfähigkeit.

Diese robusten Heizwalzen sind speziell für anspruchsvolle Betriebsbedingungen in der Fixierstation und für schnellere Kopierer mit positiv oder negativ geladenem Toner konstruiert.

**TRITON™ II Heizwalzen** zeichnen sich durch ihre hochwertige TEFLON® -Beschichtung aus, die herkömmlichen Fluorpolymer-Beschichtungen in Bezug auf Fixier- und Antihaf-Eigenschaften überlegen ist. Spezielle antistatisch wirkende Partikel in der TRITON II-Beschichtung und hohe Fertigungsstandards tragen zu den ausgezeichneten Antihaf-Eigenschaften und der hervorragenden Verschleißfestigkeit dieser Heizwalzen bei.

Sie bieten potentiell längere Laufzeiten in ausgewählten Geräten sowohl mit positiv als auch mit negativ geladenem Toner.

## Central/Eastern Europe

Telephone: 31(0)183-696969

Fax: 31(0)183-629055

E-mail: [order@edc.katun.com](mailto:order@edc.katun.com)

**Die TRITON BLUE™ Oberen Heizwalzen** bieten eine hervorragende Leistung in Maschinenanwendungen, bei denen die Heizwalzen stark beansprucht werden. Die TRITON BLUE™ Heizwalzen werden mit einer fortschrittlichen TEFLON®-Beschichtung hergestellt, die eine höhere Heizleistung und bessere Antihaft-Eigenschaften im Vergleich zu herkömmlichen Fluorpolymerbeschichtungen bietet. Darüber hinaus zeichnen sich diese Heizwalzen durch eine hohe Verschleißfestigkeit aus.

**REVOLUTION™ Obere Heizwalzen** zeichnen sich durch eine PFA-Beschichtung aus, die umweltfreundlicher ist als die traditionelle Sprühtechnologie. Gleichzeitig werden eine einheitliche Beschichtungsdicke und eine gleichmäßige Hitzeverteilung sichergestellt. Zu den Vorteilen dieser Heizwalzen gehören eine optimale Fixierung, eine hervorragende Verschleißfestigkeit und eine lange Lebensdauer auch bei umfangreichen Druckläufen.

**TUF/SIL™ Heizwalzen** besitzen eine Silikonbeschichtung, die für eine effiziente regulierte Wärmeableitung an den Toner sorgt, sowie eine besonders zusammengesetzte TEFLON®-Beschichtung mit ausgezeichneten Antihaft-Eigenschaften und hoher Verschleißfestigkeit. Dies führt zu weniger Toner-Offsetting-Problemen und gewährleistet auch unter anspruchsvollen Betriebsbedingungen eine gleichbleibend hohe Kopienqualität. Die TEFLON®/SILIKON Heizwalzen bieten ein sehr gutes Preis-/Leistungsverhältnis für ausgewählte Geräte, die höchste Qualitätsansprüche in Bezug auf die Kopienqualität stellen.

**MICROSLEEVE™** Presswalzen mit Antihaft-PFA-Ummantelung in den Stärken 50, 70 und 100 µm bieten eine außergewöhnliche Haltbarkeit und damit eine langfristig bessere Kopienqualität und längere Nutzungsdauer. Die Presswalzen der MICROSLEEVE™ A-Serie sind speziell für den Einsatz in Geräten gedacht, bei denen eine Reinigung der unteren Presswalze mittels Reinigungswalze stattfindet. Ihre besondere Oberflächenstruktur reduziert Tonerablagerungen und verbessert die Reinigungswirkung in der Fixierstation.

Alle Heizwalzen von Katun wurden speziell im Hinblick auf deren Einsatzzweck entwickelt und erfüllen höchste Qualitätsstandards. Nicht umsonst zeichnen sie sich durch eine herausragende Leistung und eine lange Nutzungsdauer aus.

## Beschichtungstechnologien für Reinigungswalzen

Katun hat spezielle Reinigungswalzen für Geräte entwickelt, die eine wirksame Beseitigung von Tonerresten und Schmutz sowie eine kontinuierliche Versorgung wichtiger Teile der Fixierstation mit Silikonöl erfordern. Durch den Einsatz einer Katun Reinigungswalze kann bei vielen Geräten eine optimale Kopienqualität und eine größtmögliche Nutzungsdauer der Komponenten erzielt werden.

**FIBRA™** Reinigungswalzen entfernen Tonerreste und Schmutzpartikel durch ein spezielles Fasernetz effizient von der Walzenoberfläche. Während das FIBRA-Fasernetz die Verschmutzungen wirkungsvoll in seiner Oberfläche aufnimmt, sorgt es zugleich für eine Dauerversorgung wichtiger Teile der Fixierstation mit Silikonöl aus dem Vorratstank im Walzeninneren.

**FIBRA™II** Reinigungswalzen besitzen ein neuartiges, hitzebeständiges Fasernetz, mit denen besonders unter anspruchsvollen Betriebsbedingungen eine erheblich verbesserte Reinigungswirkung erzielt wird.

Durch die wirksame Aufnahme von Tonerresten und Schmutzstoffen bei gleichzeitiger Dauerversorgung wichtiger Teile in der Fixierstation mit Silikonöl können die Austausch- und Servicekosten für die Fixierstation erheblich gesenkt werden.

TEFLON® ist ein eingetragenes Warenzeichen von E.I. DuPont de Nemours and Company und wird von der Katun Corporation unter Lizenz verwendet.



## **Firmenetiketten-Programm**

Katun bietet Händlern einen äußerst kostengünstigen Weg, ihre Kunden an sich zu binden und Kundenbeziehungen zu verbessern. Das **Firmenetiketten-Programm** erlaubt es Händlern, qualitativ hochwertige Verbrauchsmaterialien von Katun Performance (Toner, Drucker-/Faxkartuschen, Tinten für Digitalkopierer und Thermotransferrollen) mit ihrem Firmennamen und/oder Logo sowie mit Kontaktinformationen zu versehen. So wissen Verbraucher immer, bei wem sie Produkte nachbestellen können. Für eine einmalige, geringe Bearbeitungsgebühr entwirft und produziert Katun Performance vollfarbige Etiketten nach Ihren eigenen Angaben. Diese werden kostenfrei auf die entsprechenden Verpackungen aufgebracht. Unter dieses Programm fallen nur Produkte, die vom Endverbraucher nachbestellt werden können. Die Teilnahme an dem Programm ist ganz einfach. Füllen Sie einfach die Vereinbarung aus und senden Sie diese an Ihren Katun- Ansprechpartner oder besuchen Sie uns auf unserer Homepage-unter Firmenetiketten-Programm für weitere Information zu diesem Programm und den Teilnahmebedingungen.



# Personalized Product Agreement

## Customer Information

Customer Number: \_\_\_\_\_ Phone Number: \_\_\_\_\_  
 Contact Name: \_\_\_\_\_ Fax Number: \_\_\_\_\_  
 Title: \_\_\_\_\_ Katun Representative: \_\_\_\_\_

### Customer agrees to:

- Provide pertinent information, a scanable copy of your company logo, or other desired label artwork, and color specifications for the labels.
- Pay a one-time, nominal setup fee upon approval of the label design. (Ask your sales representative for details.)
- Order in full master carton quantities.

### Katun agrees to:

- Create a personalized, full-color label design to your specifications, per the information provided on page two of this form, for a one-time, nominal setup fee and send a proof for approval within a minimum of 7 days of receipt of this agreement.
- Produce labels printed with the customer's approved design on white label stock, and affix them over the Katun Performance logo\* on copier toner, printer/fax toner cartridge, digital duplicator ink/master packaging.
- Ship initial order within one week after the customer approves their Personalized Product label proof. Reorders will also ship within one week.

## Projected Personalized Product Purchases

<i>Katun Part Number**</i>	<i>OEM Line</i>	<i>Product/Model Description</i>	<i>Minimum Order Quantity</i>	<i>Projected Monthly Order***</i>
P			<i>One master carton</i>	
P			<i>One master carton</i>	
P			<i>One master carton</i>	
P			<i>One master carton</i>	
P			<i>One master carton</i>	
P			<i>One master carton</i>	

Signature: \_\_\_\_\_ Date: \_\_\_\_\_

\*Only Katun Performance products can be personalized.

\*\*The Personalized Product part number is the regular Katun Performance part number with a 'P' added at the end. See the Katun catalog for master carton quantities.

\*\*\***Projection only.** You are not committed to ordering the quantity you list on this form.

NOTE: Products with personalized labels cannot be returned to Katun for credit unless a valid warranty claim exists.

**Please Also Complete Page 2**

## Central/Eastern Europe

Telephone: 31(0)183-696969

Fax: 31(0)183-629055

E-mail: [order@edc.katun.com](mailto:order@edc.katun.com)

### **Information for Personalized Product Label**

Please list *only* the information you want to appear on your Personalized Product label.

**Company Name:** \_\_\_\_\_

**Street Address:** \_\_\_\_\_

**City:** \_\_\_\_\_

**State/Province:** \_\_\_\_\_ **Postal Code:** \_\_\_\_\_

**Phone Number:** \_\_\_\_\_ **Fax Number:** \_\_\_\_\_

**Other:** \_\_\_\_\_

### **Label Artwork**

- **Attach a copy of your company logo and/or any other requested graphic elements.** Artwork may be full color or black and white. We prefer original-quality artwork 4" x 4" (100mm x 100mm) or larger, but will accept a business card or sheet of company letterhead.
- **Please indicate your color preferences.** In the space below, please indicate the color(s) you want to use for all text, your company logo, and any other graphic elements. If appropriate, please supply accurate samples to be matched or specify Pantone or PMS color numbers. **NOTE:** Your labels will be printed on a thermal-transfer printer at a resolution of 300 dpi. Therefore color photographs cannot be printed and some colors may be difficult to match precisely.

### **Label Sizes**

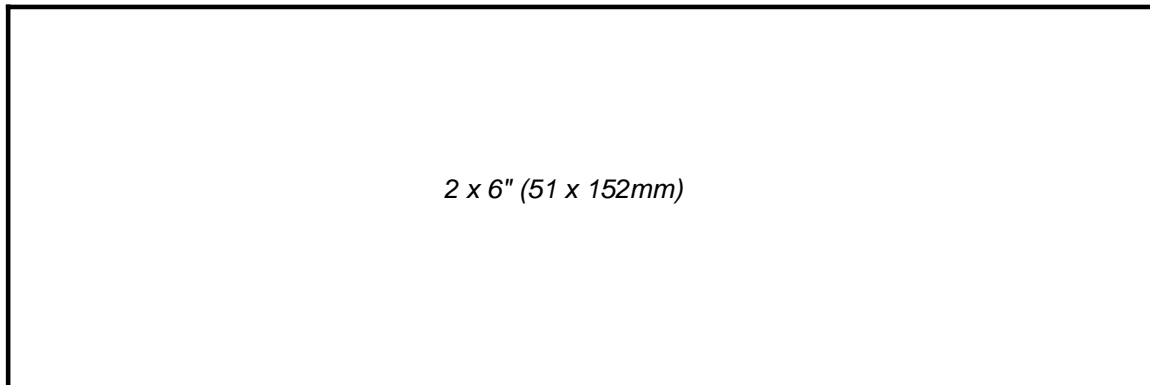
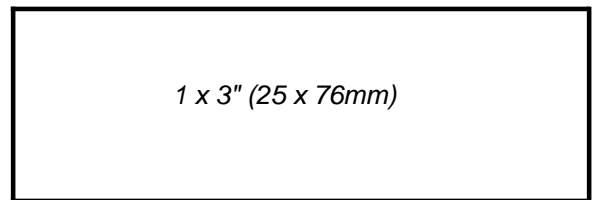
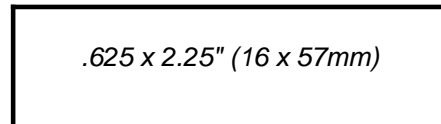
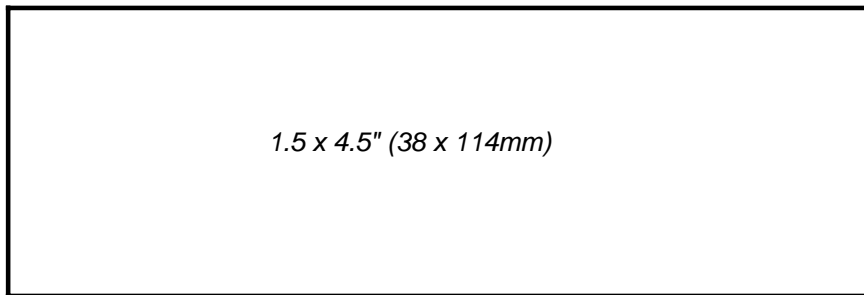

## Vereinbarung über Bestellung von Produkten mit Ihrem Firmenetikett

### Kundeninformationen

Kundennummer: \_\_\_\_\_ Telefon: \_\_\_\_\_  
 Ansprechpartner: \_\_\_\_\_ Fax: \_\_\_\_\_  
 Position: \_\_\_\_\_ Ihr Katun-Repräsentant: \_\_\_\_\_

### Der Kunde ist einverstanden:

- Katun die benötigten Informationen vorzulegen (ein zum Scannen geeignetes Muster Ihres Firmenlogos bzw. Muster anderer gewünschter Grafikelemente sowie Farbspezifikationen für die Etiketten);
- nach Genehmigung des Etiketten-Layouts eine einmalige, geringe Bearbeitungsgebühr zu entrichten. Weitere Informationen erhalten Sie von Ihrem Katun-Repräsentanten;
- Toner in den jeweiligen Verpackungseinheiten/Umkartons zu bestellen.

### Katun verpflichtet sich:

- ein Vollfarbetikett nach den Kundenangaben zu entwerfen (siehe Seite 2 dieses Formulars). Hierfür wird eine einmalige, geringe Bearbeitungsgebühr erhoben. Nach Eingang dieser Vereinbarung bei Katun erhält der Kunde innerhalb von ca. sieben Werktagen einen Korrekturabzug.
- Etiketten in Standardgröße mit dem vom Kunden genehmigten Layout auf weißem Etikettenpapier zu drucken und über dem Katun Performance-Logo\* auf der Verpackung von Toner für Kopierer, Tonerkartuschen für Drucker/Faxgeräte, Tinte bzw. deren Umkartons für digitale Duplikatoren anzubringen.
- den Toner-Erstauftrag innerhalb von einer Woche nach Genehmigung des firmeneigenen Etiketts zu versenden. Nachbestellungen werden ebenfalls innerhalb einer Woche erledigt.

### Erwartete Abnahmemenge von Produkten mit Ihrem Firmenetikett

Katun Artikelnummer**	Maschinenlinie	Produkt-/Modellbeschreibung	Mindestmenge	Erwartete monatliche Bestellung***
P			Ein Umkarton	
P			Ein Umkarton	
P			Ein Umkarton	
P			Ein Umkarton	
P			Ein Umkarton	
P			Ein Umkarton	

Unterschrift: \_\_\_\_\_ Datum: \_\_\_\_\_

\*Nur Katun Performance Produkte können mit Firmenetiketten bestellt werden.

\*\*Die Artikelnummer für Produkte mit Ihrem Firmenetikett ist die normale Katun Performance Artikelnummer, der ein "P" am Ende nachgestellt ist. Sehen Sie die Umkartonmengen im Katun-Katalog nach.

\*\*\***Nur Schätzungen.** Sie sind nicht verpflichtet, die hier angegebene Menge abzunehmen.

HINWEIS: Produkte mit Firmenetiketten können nur bei einer berechtigten Reklamation gutgeschrieben werden.

**Füllen Sie bitte auch Seite 2 aus.**

## Bestellinformationen für firmeneigenes Etikett

Geben Sie bitte *nur* die Informationen an, die auf dem Etikett erscheinen sollen.

Name der Firma: \_\_\_\_\_

Strasse: \_\_\_\_\_

PLZ/Ort: \_\_\_\_\_

Telefon: \_\_\_\_\_ Fax: \_\_\_\_\_

Sonstiges: \_\_\_\_\_

## Layout des Etiketts

- **Bitte legen Sie kein Muster Ihres Firmenlogos sowie ggf. Muster anderer gewünschter Grafikelemente bei.** Geeignet sind Grafiken in Farbe oder Schwarzweiß, vorzugsweise Originale mit einer Mindestgröße von 100 x 100 mm. Wir können auch Ihre Visitenkarte oder Ihren Briefkopf verarbeiten.
- **Bitte geben Sie die gewünschten Farben an.** Tragen Sie unten bitte die Farbe(n) für alle Textelemente, Ihr Firmenlogo sowie andere grafische Elemente ein. Legen Sie ggf. ein Farbmuster bei, oder geben Sie die Pantone- bzw. PMS-Farbnummern an.  
**HINWEIS:** Ihre Firmenetiketten werden auf einem Thermodrucker mit einer Auflösung von 300 DPI erstellt. Es können daher keine Farbfotos gedruckt werden, und bestimmte Farben können u. U. nicht exakt wiedergegeben werden.





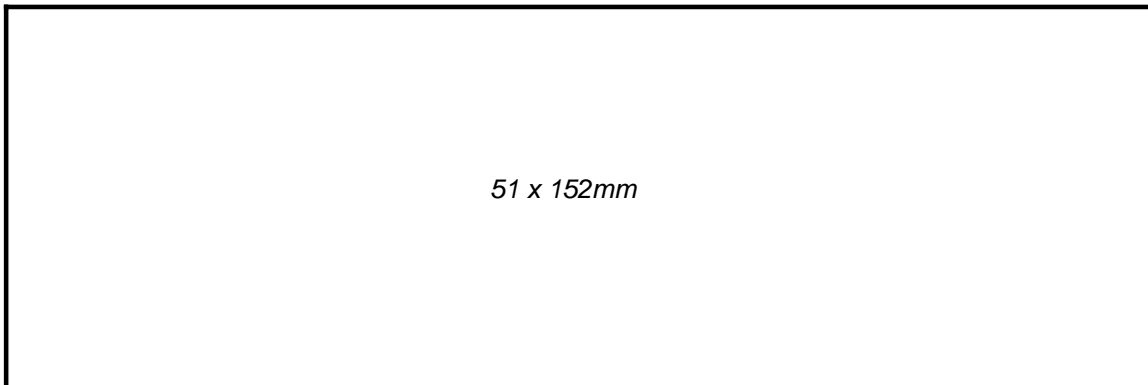
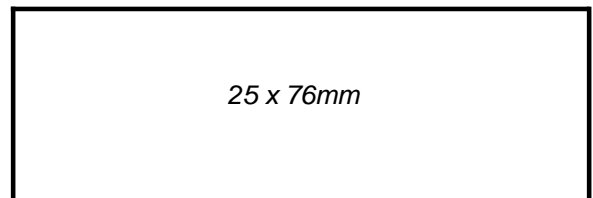
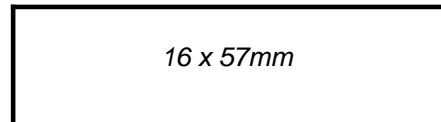
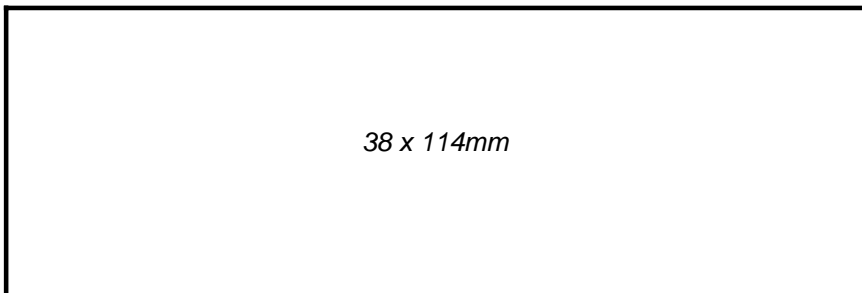



## Etikettengrößen

















For use in  
**Toshiba**  
 Copiers

**Central/Eastern Europe**  
 Telephone: 31(0)183-696969  
 Fax: 31(0)183-629055  
 E-mail: order@edc.katun.com

OEM PN	KATUN PN	DESCRIPTION	MODEL NO.
<b>Bearings/Bushings</b>			
4408 510800	43576233 	<b>Bearing</b>	1550, 1560, 1650, 1710, 2050, 2060, 2310, 2500, 2540, 2860, 2870, 3210, 3240, 3560, 3570, 3850 D, 4560, 4570, 5540, 6550, 6560, 7550, 7560, 7650, 7660, BD 9100, BD 9110, BD 9230, BD 9240, DP 2460, DP 3580, DP 4580, DP 5570, DP 6570, DP 8070, e-STUDIO 55, e-STUDIO 65, e-STUDIO 80, e-STUDIO 210 c, e-STUDIO 310 c, E-STUDIO 550, E-STUDIO 650, E-STUDIO 810, E-STUDIO 3511, E-STUDIO 4511, FC 15, FC 15 i, FC 22, FC 22 i, MP- 4001, MP- 4003
4407 548100	43021531 	<b>Lower Fuser Roller Bearing</b>	1550, 1560, 1650, 1710, 2050, 2310, 2500, 2510, 2540, 2550, 3210, 3220, 3240, 3550, 3850 D, 4010, 4550, 4560, 4570, BD 3110, BD 3301, BD 4111, BD 4121, BD 4130, BD 4140, BD 4810, BD 4910, BD 5110, BD 5120, BD 5610, BD 5620, BD 5910, BD 7610, BD 7720, BD 7811, BD 7812, BD 7815, BD 7816, BD 7910, BD 8411, BD 8412, BD 8510, BD 8811, BD 8812
4400 919430	43013954 	<b>Upper Fuser Roller Bushing</b>	1650, 2050, 2540
4402 210260	43013954 	<b>Upper Fuser Roller Bushing</b>	1710, 2310, 2500, 2510, 2550
4407 545610	43576204 	<b>Bearing</b> Various Applications	1710, 2310, 2500, 2510, 2550, 3220, 3550, 3850 D, 4010, 4550, 5010, 5020, 5540, 6550, 6560, 7550, 7560, 7650, 7660, BD 4111, BD 4121, BD 4130, BD 4140, BD 4810, BD 4910, BD 5110, BD 5120, BD 5610, BD 5620, BD 5910, BD 7610, BD 7720, BD 7811, BD 7812, BD 7815, BD 7816, BD 8411, BD 8412, BD 8510, BD 8811, BD 8812, BD 9100, BD 9110, BD 9230, BD 9240, DP 4580, DP 5570, DP 6570, DP 8070, e-STUDIO 28, e-STUDIO 35, e-STUDIO 45, e-STUDIO 55, e-STUDIO 65, e-STUDIO 80, e-STUDIO 210 c, e-STUDIO 310 c, E-STUDIO 350, E-STUDIO 450, E-STUDIO 550, E-STUDIO 650, E-STUDIO 810, E-STUDIO 3511, E-STUDIO 4511, MG- 2001, MG- 2004, MG- 2005, MG- 2501, MG- 2502
4407 548060	43576225 	<b>Upper Fuser Roller Bearing</b>	2060, 2860, 2870, 3210, 3220, 3240, 3550, 3560, 3570, 3850 D, 4010, 4550, 4560, 4570, 5010, 5020, 5540, 6550, 6560, 7550, 7560, 7650, 7660, BD 4810, BD 4910, BD 5110, BD 5120, BD 5610, BD 5620, BD 5910, BD 7610, BD 7720, BD 7811, BD 7812, BD 7815, BD 7816, BD 7910, BD 8510, BD 9100, BD 9110, BD 9230, BD 9240, DP 2460, DP 2570, DP 3580

*Priced per Bushing,  
 sold in Bags of 10.*

















*Priced per Bushing,  
 sold in Bags of 10.*

OEM PN	KATUN PN	DESCRIPTION	MODEL NO.	
<b>Bearings/Bushings</b>				
4401 951870	43021587 	<b>Heat Insulating Sleeve</b> 2 Heat Sleeves / Heat Sleeve	2060, 2860, 2870, 3560, 3570, 4560, 4570, DP 2460, DP 2570, DP 3580	<i>Priced per Heat Sleeve, sold in Bags of 2.</i>
4401 952220	43576205 	<b>Lower Fuser Roller Bearing</b>	2060, 2860, 2870, 3560, 3570, DP 2460, DP 2570, DP 3580	
4407 783080	43576260 	<b>Heat Insulating Sleeve</b>	3220, 3550, 3850 D, 4010, 5010, 5020, 6550, BD 3301, BD 3701, BD 4111, BD 4121, BD 4130, BD 4140, BD 4810, BD 4910, BD 5110, BD 5120, BD 5511, BD 5610, BD 5620, BD 5910, BD 7610, BD 7720, BD 7811, BD 7812, BD 7815, BD 7816, BD 7910, BD 8510, BD 9100, BD 9110, BD 9230, BD 9240	<i>Priced per Heat Sleeve, sold in Bags of 10.</i>
4842 109525	43576221 	<b>Bearing</b>	3850 D	
4407 783090	43015633 	<b>Lower Fuser Roller Bearing</b>	5010, 5020, BD 3701, BD 4515, BD 5511	
4407 546490	43576205 	<b>Bearing</b> Various Applications	5540, 6550, 6560, 7550, 7560, 7650, 7660, BD 3503, BD 4810, BD 7811, BD 7812, BD 7815, BD 7816, BD 8411, BD 8412, BD 9100, BD 9110, BD 9230, BD 9240, e-STUDIO 210 c, e-STUDIO 310 c, MD- 1	
4401 902550	43576260 	<b>Heat Insulating Sleeve</b>	5540, 6550, 6560, 7550, 7560, 7650, 7660, DP 4580, DP 5570, DP 6570, DP 8070, e-STUDIO 55, e-STUDIO 65, e-STUDIO 80, E-STUDIO 550, E-STUDIO 650, E-STUDIO 810	<i>Priced per Heat Sleeve, sold in Bags of 10.</i>
4408 308080	43021523 	<b>Lower Fuser Roller Bearing</b>	5540, 6550, BD 9100, BD 9110, BD 9230, BD 9240	
4401 902680	43576224 	<b>Lower Fuser Roller Bearing</b>	6560, 7550, 7560, 7650, 7660	
08053291	43576233 	<b>Bearing</b> Various Applications	8050	
AE030010	43576216 	<b>Upper Fuser Roller Bearing</b>	8050	
AE030011	43576224 	<b>Lower Fuser Roller Bearing</b>	8050	
AE032001	43576262 	<b>Heat Insulating Sleeve</b> Lower	8050	<i>Priced per Heat Sleeve, sold in Packages of 10.</i>
07423808	43576233 	<b>Bearing</b> Various Applications	8050, MJ- 1001	
25AA75020	43576209 	<b>Lower Fuser Roller Bearing</b>	9260	











For use in  
**Toshiba**  
Copiers

**Central/Eastern Europe**  
Telephone: 31(0)183-696969  
Fax: 31(0)183-629055  
E-mail: order@edc.katun.com







OEM PN	KATUN PN	DESCRIPTION	MODEL NO.
<b>Bearings/Bushings</b>			
454053391	43014269 	<b>Heat Insulating Sleeve</b>	9260
			<i>Priced per Heat Sleeve, sold in Bags of 10.</i>
454075040	43576216 	<b>Upper Fuser Roller Bearing</b>	9260
508053410	43576233 	<b>Bearing</b> Various Applications	9260, MP- 2001
4401 180150	43576205 	<b>Bearing</b> Various Applications	BD 608, BD 704, BD 3802, BD 7101
4404 143210	43576224 	<b>Fuser Roller Bearing</b> Upper	BD 3503, BD 4501, BD 4511, BD 4515
4407 027340	43576221 	<b>Lower Fuser Roller Bearing</b>	BD 3503, BD 4501, BD 4511, BD 7501, BD 7511
4404 740490	43576224 	<b>Upper Fuser Roller Bearing</b>	BD 7501, BD 7511
4407 577910	43021526 	<b>Upper Fuser Roller Bearing</b>	BD 8411, BD 8412, BD 8811, BD 8812
35920130	43576233 	<b>Lower Fuser Roller Bearing</b> Lower Fuser Roller	DP 1570, DP 1570 F, DP 1870 F
60912270	43576233 	<b>Bearing</b> Various Applications	DP 1570, DP 1570 F, DP 1870 F
4406 363680	43576233 	<b>Bearing</b>	DP 4580, DP 5570, DP 6570, DP 8070, e-STUDIO 16, e-STUDIO 16 s, e-STUDIO 20, e-STUDIO 20 s, e-STUDIO 25, e-STUDIO 25 s, e-STUDIO 55, e-STUDIO 65, e-STUDIO 80
4406 323710	43576216 	<b>Upper Fuser Roller Bearing</b>	DP 4580, DP 5570, DP 6570, DP 8070, e-STUDIO 55, e-STUDIO 65, e-STUDIO 80
4406 364240	43576233 	<b>Bearing</b>	DP 4580, DP 5570, DP 6570, DP 8070, e-STUDIO 55, e-STUDIO 65, e-STUDIO 80
4842 210405	43576131 	<b>Bearing</b>	DP 4580, DP 5570, DP 6570, DP 8070, e-STUDIO 55, e-STUDIO 65, e-STUDIO 80
4406 323720	43576224 	<b>Lower Fuser Roller Bearing</b>	DP 4580, DP 5570, DP 6570, DP 8070, e-STUDIO 55, e-STUDIO 65, e-STUDIO 80, E-STUDIO 550, E-STUDIO 650, E-STUDIO 810
4407 922440	43576118 	<b>Bearing</b> Various Applications	DP 4580, DP 5570, DP 6570, DP 8070, e-STUDIO 55, e-STUDIO 65, e-STUDIO 80, E-STUDIO 550, E-STUDIO 650, E-STUDIO 810
		Various Applications	MD- 1
41330 533800	43020088 	<b>Upper Fuser Roller Bushing</b>	e-STUDIO 12, e-STUDIO 15, E-STUDIO 120, E-STUDIO 150
			<i>Priced per Bushing, sold in Bags of 10.</i>



















OEM PN	KATUN PN	DESCRIPTION	MODEL NO.	
<b>Bearings/Bushings</b>				
NBRGP0567FCZZ	43020088 	<b>Upper Fuser Roller Bushing</b>	e-STUDIO 12, e-STUDIO 15, E-STUDIO 120, E-STUDIO 150	<i>Priced per Bushing, sold in Bags of 10.</i>
41306 058000	43021351 	<b>Fuser Cleaning Bushing</b>	e-STUDIO 16, e-STUDIO 16 s, e-STUDIO 20, e-STUDIO 20 s, e-STUDIO 25, e-STUDIO 25 s	<i>Priced per Bushing, sold in Bags of 2.</i>
41306 059000	43021352 	<b>Upper Fuser Roller Bushing</b>	e-STUDIO 16, e-STUDIO 16 s, e-STUDIO 20, e-STUDIO 20 s, e-STUDIO 25, e-STUDIO 25 s	<i>Priced per Bushing, sold in Bags of 2.</i>
44202 925000	43576205 	<b>Lower Fuser Roller Bearing</b>	e-STUDIO 28, e-STUDIO 35, e-STUDIO 45, E-STUDIO 350, E-STUDIO 450	
AE030035	43576118 	<b>Bearing</b>	E-STUDIO 900, E-STUDIO 1050	
07403008	43576205 	<b>Bearing</b> Various Applications	E-STUDIO 900, E-STUDIO 1050, MP- 3501	
4406 522870	43576209 	<b>Upper Fuser Roller Bearing</b>	FC 15, FC 15 i, FC 22, FC 22 i	
066077020	43576233 	<b>Bearing</b>	MR- 3004, MY- 1005	

For use in  
**Toshiba**  
 Copiers

**Central/Eastern Europe**  
 Telephone: 31(0)183-696969  
 Fax: 31(0)183-629055  
 E-mail: order@edc.katun.com

OEM PN	KATUN PN	DESCRIPTION	MODEL NO.
<b>Belts</b>			
4401 794580	43014644 	<b>Original Document Feed Belt</b>	3850 D, 4550, 5010, 5020, 5540, 5560, 6550, 6560, 7550, 7560, 7650, 7660, MR- 2002, MR- 3001, MR- 3003
4400 690220	43017239 	<b>Document Feed Belt</b>	4560, 4570, MR- 2004, MR- 2008, MR- 3006
4402 241830	43014644 	<b>Original Document Feed Belt</b>	5010, 5020, MR- 2002, MR- 3001, MR- 3003
4406 364170	43014644 	<b>Original Document Feed Belt</b>	DP 4580, DP 5570, DP 6570, DP 8070, e-STUDIO 55, e-STUDIO 65, e-STUDIO 80
4409 892810	43019202 	<b>Transfer Belt</b>	DP 4580, DP 5570, DP 6570, DP 8070, e-STUDIO 55, e-STUDIO 65, e-STUDIO 80
		Kit Contains: • (1) Transfer Belt	
A2933899	43018005 	<b>Transfer Belt</b>	E-STUDIO 900, E-STUDIO 1050

OEM PN	KATUN PN	DESCRIPTION	MODEL NO.
<b>Blades/Brushes</b>			
BL 1210 D	43012530 	<b>Drum Cleaning Blade</b>	1210
BL 1210 H	43012577 	<b>Fuser Roller Cleaning Felt</b>	1210
BL 140 D	43243433 	<b>Drum Cleaning Blade</b>	1310, BD 3810, BD 3910
BL 140 D	43022584	<b>Drum Cleaning Blade Access By Katun</b>	1310, BD 3810, BD 3910
4402 850190	43014374 	<b>Recovery Blade</b>	1340, 1350, 1360, 1370
BL 1350 D	43014395 	<b>Drum Cleaning Blade</b>	1340, 1350, 1360, 1370
BL 1350 H	43013943 	<b>Fuser Roller Cleaning Blade</b>	1340, 1350, 1360, 1370
4400 668610	43022562 	<b>Fuser Roller Cleaning Blade</b>	1550, 1560
BL 1550 D	43016485 	<b>Drum Cleaning Blade</b>	1550, 1560
BL 1550 D	43022585	<b>Drum Cleaning Blade Access By Katun</b>	1550, 1560
4402 808250	43010730 	<b>Recovery Blade</b>	1650, 1710, 2050, 2310, 2500, 2540, 3210, 3240
BL 1710 D	43009687 	<b>Drum Cleaning Blade</b>	1650, 1710, 2050, 2310, 2500, 2540, 3210, 3240
BL 1710 D	43022586	<b>Drum Cleaning Blade Access By Katun</b>	1650, 1710, 2050, 2310, 2500, 2540, 3210, 3240
4402 211160	43010379 	<b>Fuser Roller Cleaning Felt</b>	1710, 2310, 2500, 2510, 2550
BL 2060 D	43016883 	<b>Drum Cleaning Blade</b>	2060, 2860, 2870
BL 2060 D	43022587	<b>Drum Cleaning Blade Access By Katun</b>	2060, 2860, 2870
C2070-2825	43016883 	<b>Drum Cleaning Blade</b>	2060, 2860, 2870
4402 039580	43010154 	<b>Upper Fuser Roller Cleaning Blade</b>	2060, 2860, 2870, 3210, 3220, 3550, 3560, 3570, 3850 D, 4010, 4550, DP 2460, DP 3580
4401 953350	43016907 	<b>Recovery Blade</b>	2060, 2860, 2870, 3560, 3570, 4560, 4570
4402 215130	43010729 	<b>Recovery Blade</b>	2510, 2550, 3220, 3550, 4010, 4550
BL 2510 D	43012968 	<b>Drum Cleaning Blade</b>	2510, 2550, 3220, 4010

For use in  
**Toshiba**  
 Copiers

**Central/Eastern Europe**  
 Telephone: 31(0)183-696969  
 Fax: 31(0)183-629055  
 E-mail: order@edc.katun.com

OEM PN	KATUN PN	DESCRIPTION	MODEL NO.
<b>Blades/Brushes</b>			
BL 2510 D	43022588	<b>Drum Cleaning Blade Access By Katun</b>	2510, 2550, 3220, 4010
BL 3550 D	43012968	<b>Drum Cleaning Blade</b>	3550
BL 3560 D	43016885	<b>Drum Cleaning Blade</b>	3560, 3570
BL 4550 D	43012969	<b>Drum Cleaning Blade</b>	3850 D, 4550
BL 4560 D	43016885	<b>Drum Cleaning Blade</b>	4560, 4570
BL 5020 D <i>Final Inventory</i>	43000922	<b>Drum Cleaning Blade</b>	5010, 5020
BL 6550 D	43012702	<b>Drum Cleaning Blade</b>	5540, 6550
B 6560 <i>Final Inventory</i>	43016822	<b>Drum Cleaning Brush</b>	5560, 6560
BL 7550 D	43015351	<b>Drum Cleaning Blade</b>	5560, 6560, 7550, 7560, 7650, 7660
BL 6550 H	43014013	<b>Lower Fuser Roller Cleaning Felt</b>	6550
B 7550 <i>Final Inventory</i>	43016821	<b>Drum Cleaning Brush</b>	7550, 7560, 7650, 7660
BL 8050 D	43011803	<b>Drum Cleaning Blade</b>	8050
25AA56015	43016765	<b>Drum Cleaning Blade</b>	9260
BL 150 D	43243422	<b>Drum Cleaning Blade</b>	BD 2810
BL 100 D <i>Final Inventory</i>	43244593	<b>Drum Cleaning Blade</b>	BD 3301, BD 4111, BD 4121
BL 222 D	43243421	<b>Drum Cleaning Blade</b>	BD 4910, BD 5110, BD 5910
4409 970540 <i>Final Inventory</i>	43244548	<b>Drum Cleaning Blade</b>	BD 5120, BD 5610, BD 5620, BD 7610, BD 7720, BD 7910, BD 8510
BL 220 D <i>Final Inventory</i>	43244548	<b>Drum Cleaning Blade</b>	BD 5120, BD 5610, BD 5620, BD 7610, BD 7720, BD 7910, BD 8510
BL 231 H	43001082	<b>Fuser Roller Cleaning Felt</b>	BD 5910, BD 7610, BD 7720, BD 7910, BD 8510
BL 240 D <i>Final Inventory</i>	43000922	<b>Drum Cleaning Blade</b>	BD 9100, BD 9110, BD 9230, BD 9240
35993432	43019969	<b>Drum Cleaning Blade</b>	DP 1570, DP 1570 F, DP 1870 F















Katun Performance Product

© 2004 Katun Corporation

26 October 2004







For the most current product and pricing information, visit the Katun On-Line Catalog at [www.katun.com](http://www.katun.com).

Prices, terms and conditions are subject to change without notice.

OEM PN	KATUN PN	DESCRIPTION	MODEL NO.
<b>Blades/Brushes</b>			
BL 2460 D	43018663 	<b>Drum Cleaning Blade</b>	DP 2460, DP 2570, DP 3580
4409 892830	43021900 	<b>Transfer Belt Cleaning Brush</b>	DP 4580, DP 5570, DP 6570, DP 8070, e-STUDIO 55, e-STUDIO 65, e-STUDIO 80
4409 892960	43019789 	<b>Transfer Belt Cleaning Blade</b>	DP 4580, DP 5570, DP 6570, DP 8070, e-STUDIO 55, e-STUDIO 65, e-STUDIO 80
B 6570	43021984 	<b>Drum Cleaning Brush</b>	DP 4580, DP 5570, DP 6570, DP 8070, e-STUDIO 55, e-STUDIO 65, e-STUDIO 80
BL 6570 D	43019788 	<b>Drum Cleaning Blade</b>	DP 4580, DP 5570, DP 6570, DP 8070, e-STUDIO 55, e-STUDIO 65, e-STUDIO 80, E-STUDIO 550, E-STUDIO 650, E-STUDIO 810
		Kit Contains: • (1) Drum Cleaning Blade	
N/P/N	43019180 	<b>Drum Cleaning Blade</b>	e-STUDIO 12, e-STUDIO 15, E-STUDIO 150 Includes: Front & Rear Side Seals
AR-150CB	43020845 	<b>Cleaning Blade Kit</b>	e-STUDIO 15
			<i>Priced per Kit, 10 Blades per Kit.</i>
41303 612000	43022865 	<b>Drum Cleaning Blade</b>	e-STUDIO 16, e-STUDIO 16 s, e-STUDIO 20, e-STUDIO 20 s, e-STUDIO 25, e-STUDIO 25 s
BL3500D	43019927 	<b>Drum Cleaning Blade</b>	e-STUDIO 28, e-STUDIO 35, e-STUDIO 45
6LA58 639600	43019180 	<b>Drum Cleaning Blade</b>	E-STUDIO 120, E-STUDIO 150 Includes: Front & Rear Side Seals
AD041056	43012544 	<b>Drum Cleaning Blade</b>	E-STUDIO 900, E-STUDIO 1050
AD042038	43023241 	<b>Drum Cleaning Brush</b>	E-STUDIO 900, E-STUDIO 1050















For use in  
**Toshiba**  
 Copiers

**Central/Eastern Europe**  
 Telephone: 31(0)183-696969  
 Fax: 31(0)183-629055  
 E-mail: order@edc.katun.com

OEM PN	KATUN PN	DESCRIPTION	MODEL NO.
<b>Corona/Charge/Transfer</b>			
N/P/N	43375527 	<b>Corona Wire Spool</b> 50 m / Spool Increased plating thickness enhances corona wire life. 60μ 1.5μ Gold Plated All Applications Transfer, Separation	1210, BD 2810 1710, 2310, 2500, 2510
N/P/N	43375120 	<b>Corona Wire Spool</b> 50 m / Spool 60μ 0.3μ Gold Plated All Applications Transfer, Separation	1210, BD 2810 1710, 2310, 2500, 2510
N/P/N	43375230 	<b>Corona Wire Spool</b> Platinum alloy clad technology extends corona wire life. 80μ 7.5 m / Spool All Applications	1310, 8050, BD 3110, BD 3301, BD 3701, BD 3810, BD 3910, BD 4111, BD 4121, BD 4501, BD 4511, BD 4515, BD 4810, BD 4910, BD 5110, BD 5120, BD 5511, BD 5610, BD 5620, BD 5910, BD 7501, BD 7511, BD 7610, BD 7720, BD 7811, BD 7812, BD 7815, BD 7816, BD 7910, BD 8411, BD 8412, BD 8510, BD 8811, BD 8812, BD 9100, BD 9110, BD 9230, BD 9240  Charge 5010, 5020
N/P/N	43375547 	<b>Corona Wire Spool</b> 50 m / Spool 80μ 0.3μ Gold Plated All Applications	1310, BD 3810, BD 3910
4402 849370	43012572 	<b>Corona Wire</b> 60μ 0.3μ Gold Plated All Applications	1340, 1350, 1360, 1370
4400 674520	43016769 	<b>Charge Corona Grid</b>	1550, 1560
4400 674790	43011718 	<b>Corona Wire</b> 60μ Oxidized Various Applications  All Applications	e-STUDIO 28, e-STUDIO 35, e-STUDIO 45, E-STUDIO 350, E-STUDIO 450 1550, 1560, 2060, 2860, 2870, 3560, 3570, 4560, 4570, DP 2460, DP 3580















*Priced per Set,  
10 Corona Wires per Set.*

*Priced per Corona Wire,  
sold in Bags of 10.*

OEM PN	KATUN PN	DESCRIPTION	MODEL NO.
<b>Corona/Charge/Transfer</b>			
4402 044230	43375174 	<b>Corona Wire</b> 60μ 0.3μ Gold Plated Transfer, Separation All Applications Charge	1650, 1710, 2050, 2310, 2500, 2540, 3210, 3240 2510, 2550, 3220, 4010 3550, 3850 D, 4550
			<i>Priced per Corona Wire, sold in Sets of 10.</i>
4400 768190	43012570 	<b>Corona Wire</b> 60μ 0.3μ Gold Plated Charge	1650, 1710, 2050, 2310, 2500, 2540, 3210, 3240
			<i>Priced per Corona Wire, sold in Sets of 10.</i>
4402 808340	43014701 	<b>Charge Corona Grid</b> Stainless Steel	1650, 1710, 2050, 2310, 2500, 2540, 3210, 3240
4401 946950	43016770 	<b>Charge Corona Grid</b>	2060, 2860, 2870, 3560, 3570, 4560, 4570
4402 214310	43016713 	<b>Charge Corona Grid</b>	2510, 2550, 3220, 3550, 3850 D, 4010
C2041-8018	43016713 	<b>Charge Corona Grid</b>	2510, 2550, 3220, 3550, 3850 D, 4010
4402 068050	43014578 	<b>Corona Wire Cleaner</b>	3550, 3850 D
4402 085300	43012571 	<b>Corona Wire</b> 60μ 0.3μ Gold Plated Transfer, Separation	3550, 3850 D, 4550
			<i>Priced per Set, 10 Corona Wires per Set.</i>
4402 085520	43014594 	<b>Corona Wire Cleaning Pad</b> Transfer	3550, 4550
4402 085540	43014595 	<b>Corona Wire Cleaning Pad</b> Separation	3550, 4550
4408 631250	43019921 	<b>Corona Wire</b> 60μ 0.3μ Gold Plated Precleaning	3850 D, DP 2460, DP 3580
			<i>Priced per Corona Wire, sold in Boxes of 10.</i>
4408 631250	43019920 	<b>Corona Wire</b> 60μ 0.3μ Gold Plated Precleaning	3850 D, DP 2460, DP 3580
4402 086260	43016712 	<b>Charge Corona Grid</b>	4550
4408 607930	43011757 	<b>Corona Wire</b> Platinum alloy clad technology extends corona wire life. 80μ Platinum Alloy Clad Transfer, Separation Precleaning	5010, 5020 5540, 6550, 6560
			<i>Priced per Corona Wire, sold in Sets of 10.</i>

For use in  
**Toshiba**  
Copiers

**Central/Eastern Europe**  
Telephone: 31(0)183-696969  
Fax: 31(0)183-629055  
E-mail: order@edc.katun.com

OEM PN	KATUN PN	DESCRIPTION	MODEL NO.
<b>Corona/Charge/Transfer</b>			
4408 512240	43014593 	<b>Corona Wire Cleaner</b> Charge	5010, 5020, 5540, 6550, 7550, 7560, 7650, 7660, BD 9100, BD 9110, BD 9230, BD 9240
4401 763890	43014592 	<b>Corona Wire Cleaning Pad</b> Charge	5540, 6550
4401 764510	43015784 	<b>Corona Wire Cleaning Pad</b> Transfer	5540, 6550
4401 764530	43015785 	<b>Corona Wire Cleaning Pad</b> Separation	5540, 6550
4401 763780	43012560 	<b>Corona Wire</b> 80μ Platinum Alloy Clad Charge	5540, 6550, 7550, 7560, 7650, 7660
4401 764590	43011428 	<b>Corona Wire</b> 80μ Platinum Alloy Clad Transfer, Separation	5540, 6550, 7550, 7560, 7650, 7660
C2050-9576	43012560 	<b>Corona Wire</b> 80μ Platinum Alloy Clad Charge	5540, 6550, 7550, 7560, 7650, 7660
4402 308690	43012909 	<b>Corona Wire</b> 60μ 0.3μ Gold Plated Transfer, Separation	5560, 6560
4402 868430	43015722 	<b>Charge Corona Grid</b>	5560, 6560, DP 4580, DP 5570, DP 6570, DP 8070, e-STUDIO 55, e-STUDIO 65, e-STUDIO 80
4402 308040	43014737 	<b>Corona Wire</b> 60μ Oxidized Charge	5560, 6560, DP 4580, DP 5570, DP 6570, DP 8070, e-STUDIO 55, e-STUDIO 65, e-STUDIO 80, E-STUDIO 550, E-STUDIO 650, E-STUDIO 810
4401 905050	43014592 	<b>Corona Wire Cleaner</b> Charge	6560, 7550, 7560, 7650, 7660
4401 905160	43015785 	<b>Corona Wire Cleaning Pad</b> Separation	6560, 7550, 7560, 7650, 7660
4401 905180	43015784 	<b>Corona Wire Cleaning Pad</b> Transfer	6560, 7550, 7560, 7650, 7660
52199101	43375591 	<b>Corona Wire</b> 80μ Carbon Coated All Applications	8050

*Priced per Corona Wire,  
sold in Sets of 10.*

*Priced per Corona Wire,  
sold in Sets of 10.*

*Priced per Corona Wire,  
sold in Sets of 10.*

*Priced per Corona Wire,  
sold in Sets of 10.*









*Priced per Corona Wire,  
sold in Sets of 10.*

*Priced per Set,  
10 Corona Wires per Set.*



Katun Performance Product





© 2004 Katun Corporation

OEM PN	KATUN PN	DESCRIPTION	MODEL NO.
<b>Corona/Charge/Transfer</b>			
52199535	43375591 	<b>Corona Wire</b> 80μ Carbon Coated All Applications	8050  <i>Priced per Set, 10 Corona Wires per Set.</i>
A1719504	43375591 	<b>Corona Wire</b> 80μ Carbon Coated All Applications	8050  <i>Priced per Set, 10 Corona Wires per Set.</i>
4401 172070	43375558 	<b>Corona Wire Spool</b> 50 m / Spool 80μ Unpolished All Applications	BD 608, BD 704, BD 3110, BD 3301, BD 3503, BD 3701, BD 3802, BD 4111, BD 4501, BD 4511, BD 4515, BD 5511, BD 5610, BD 5620, BD 5910, BD 7101, BD 7501, BD 7511, BD 7610, BD 7720, BD 7811, BD 7812, BD 7815, BD 7816, BD 8411, BD 8412, BD 8811, BD 8812  Charge, Separation Transfer, Separation
N/P/N	43375553 	<b>Corona Wire Spool</b> 50 m / Spool 80μ Polished Transfer	BD 4121
74669000	43011002 	<b>Corona Wire Spool</b> 50 m / Spool 60μ Oxidized Charge	DP 1570, DP 1570 F, DP 1870 F
4408 672480	43020049 	<b>Charge Corona Grid</b>	DP 2460, DP 2570, DP 3580, e-STUDIO 28, e-STUDIO 35, e-STUDIO 45, E-STUDIO 350, E-STUDIO 450, E-STUDIO 3511, E-STUDIO 4511
4408 672510	43019918 	<b>Corona Wire</b> 60μ Oxidized Various Applications  All Applications	e-STUDIO 28, e-STUDIO 35, e-STUDIO 45, E-STUDIO 350, E-STUDIO 450  DP 2460, DP 3580
4408 672510	43019919 	<b>Corona Wire</b> 60μ Oxidized Various Applications  All Applications	e-STUDIO 28, e-STUDIO 35, e-STUDIO 45, E-STUDIO 350, E-STUDIO 450  DP 2460, DP 3580  <i>Priced per Corona Wire, sold in Sets of 10.</i>
4409 892820	43021520 	<b>Transfer Charging Roller</b>	DP 4580, DP 5570, DP 6570, DP 8070, e-STUDIO 55, e-STUDIO 65, e-STUDIO 80



For use in  
**Toshiba**  
 Copiers

**Central/Eastern Europe**  
 Telephone: 31(0)183-696969  
 Fax: 31(0)183-629055  
 E-mail: order@edc.katun.com

OEM PN	KATUN PN	DESCRIPTION	MODEL NO.
<b>Corona/Charge/Transfer</b>			
CR 8070 TR	43021520 	<b>Transfer Charging Roller</b>	DP 8070, e-STUDIO 80
41330 510600	43375548 	<b>Corona Wire Spool</b> 50 m / Spool 70μ Oxidized Transfer, Separation	e-STUDIO 12, e-STUDIO 15, E-STUDIO 120, E-STUDIO 150
41304 008000	43019916 	<b>Corona Wire</b> 60μ 0.3μ Gold Plated Transfer, Separation	e-STUDIO 16, e-STUDIO 16 s, e-STUDIO 20, e-STUDIO 20 s, e-STUDIO 25, e-STUDIO 25 s
41304 008000	43019917 	<b>Corona Wire</b> 60μ 0.3μ Gold Plated Transfer, Separation	e-STUDIO 16, e-STUDIO 16 s, e-STUDIO 20, e-STUDIO 20 s, e-STUDIO 25, e-STUDIO 25 s
A0962057	43013164 	<b>Charge Corona Grid</b>	E-STUDIO 900, E-STUDIO 1050

*Priced per Corona Wire,  
 sold in Bags of 10.*

OEM PN	KATUN PN	DESCRIPTION	MODEL NO.
<b>Developers</b>			
D1210	43013551	<b>Black Developer Original</b> 420 g / Bottle	1210
D1350	43018501	<b>Black Developer Original</b> 430 g / Bottle	1340, 1350, 1360, 1370
D1550	43018461	<b>Black Developer Original</b> 670 g / Bottle	1550, 1560
D1710	43013554	<b>Black Developer Original</b> 650 g / Bottle	1650, 1710, 2050, 2310, 2500, 2540, 3210, 3220, 3240, 4010
D2060	43017258	<b>Black Developer Original</b> 500 g / Bottle	2060, 2860, 2870
D4550	43013597	<b>Black Developer Original</b> 650 g / Bottle	3550, 4550
D3560	43017172	<b>Black Developer Original</b> 500 g / Bottle	3560, 3570
D4560	43017173	<b>Black Developer Original</b> 570 g / Bottle	4560, 4570
D6550	43015418	<b>Black Developer Original</b> 1276 g / Bottle	5540, 6550
D6560	43017174	<b>Black Developer Original</b> 1300 g / Bottle	5560, 6560
D7550	43017175	<b>Black Developer Original</b> 1300 g / Bottle	7550, 7560, 7650, 7660
D2460	43020139	<b>Black Developer Original</b> 450 g / Bottle	DP 2460, DP 2570
D3580	43020862	<b>Black Developer Original</b> 500 g / Bottle	DP 3580
D6570	43022025	<b>Black Developer Original</b> 1500 g / Bottle	DP 4580, DP 5570, DP 6570, DP 8070, e-STUDIO 55, e-STUDIO 65, e-STUDIO 80
D1600	43024093	<b>Black Developer Original</b> 210 g / Bottle	e-STUDIO 16, e-STUDIO 16 s, e-STUDIO 20, e-STUDIO 20 s, e-STUDIO 25, e-STUDIO 25 s



For use in  
**Toshiba**  
Copiers

**Central/Eastern Europe**  
Telephone: 31(0)183-696969  
Fax: 31(0)183-629055  
E-mail: [order@edc.katun.com](mailto:order@edc.katun.com)









OEM PN	KATUN PN	DESCRIPTION	MODEL NO.
-----------	-------------	-------------	--------------

---

**Developers**

---











D3500	43021582	<b>Black Developer Original</b> 450 g / Bottle	e-STUDIO 28, e-STUDIO 35, e-STUDIO 45, E-STUDIO 350, E-STUDIO 450
-------	----------	---	--











OEM PN	KATUN PN	DESCRIPTION	MODEL NO.	
<b>Feed/Delivery</b>				
4400 682770	43017098 	<b>Paper Pickup/Feed Roller</b> Tire Only	1550, 1560, FC 15, FC 15 i, FC 22, FC 22 i, MY- 1004	<i>Priced per Tire, sold in Bags of 10.</i>
4402 038460	43009693 	<b>Paper Feed Roller</b> Tire Only	1560, 2060, 2510, 2550, 2860, 2870, 3220, 3550, 3560, 3570, 3850 D, 4010, 4550, 4560, 4570, 5010, 5020, 5540, 5560, 6550, 6560, 7550, 7560, 7650, 7660, BD 9230, BD 9240, ChromaTouch 1000, DP 2460, DP 2570, DP 3580, DP 4580, DP 5570, DP 6570, DP 8070, e-STUDIO 28, e-STUDIO 35, e-STUDIO 45, e-STUDIO 55, e-STUDIO 65, e-STUDIO 80, FC 15, FC 15 i, FC 22, FC 22 i, KD- 2001, KD- 2002, KD- 3005, MD- 3, MD- 4, MY- 1016	<i>Priced per Tire, sold in Bags of 10.</i>
4401 966500	43017818 	<b>Bypass Pickup Roller</b> Tire Only	1560, 2060, 2860, 2870, 3560, 3570, 4560, 4570, DP 2460, DP 2570, DP 3580, e-STUDIO 28, e-STUDIO 35, e-STUDIO 45, MY- 1016	<i>Priced per Tire, sold in Bags of 10.</i>
4400 917630	43009697 	<b>Paper Pickup Roller</b> Tire Only	1650, 2050, 2540, 3240	<i>Priced per Tire, sold in Bags of 10.</i>
4400 927500	43014327 	<b>Separation Pad</b>	1650, 2050, 2540, 3240	<i>Priced per Separation Pad, sold in Boxes of 5.</i>
N/P/N	43015619 	<b>Feed Tire Replacement Kit</b> Tire Only Kit Contains: • (1) Paper Feed Tire • (2) Paper Pickup Tire • (1) Separation Pad	1650, 2050, 2540, 3240	
4401 773050	43009693 	<b>Manual Paper Feed Roller</b> Tire Only	1650, 2050, 2540, 3240, 5540, 5560, 6550, 6560, 7550, 7560, 7650, 7660, DP 4580, DP 5570, DP 6570, DP 8070, e-STUDIO 55, e-STUDIO 65, e-STUDIO 80, E-STUDIO 550, E-STUDIO 650, E-STUDIO 810	<i>Priced per Tire, sold in Bags of 10.</i>
4401 773060	43009694 	<b>Manual Pickup Roller</b> Tire Only	1710, 2050, 2310, 2500, 2540, 3210, 3240, 5540, 5560, 6550, 6560, 7550, 7560, 7650, 7660, DP 4580, DP 5570, DP 6570, DP 8070, e-STUDIO 55, e-STUDIO 65, e-STUDIO 80	<i>Priced per Tire, sold in Bags of 10.</i>
4402 038540	43009693 	<b>Paper Feed Roller</b> Tire Only	1710, 2310, 2500, 2510, 2550, 3210, 3220, 3550, 3850 D, 4010, 4550, 5010, 5020, 5540, 6550, 6560, 7550, 7560, 7650, 7660, DP 4580, DP 5570, DP 6570, DP 8070, e-STUDIO 55, e-STUDIO 65, e-STUDIO 80, E-STUDIO 550, E-STUDIO 650, E-STUDIO 810, KD- 1001, MP- 4001, MP- 4003, MY- 1001	<i>Priced per Tire, sold in Bags of 10.</i>



For use in  
**Toshiba**  
Copiers













**Central/Eastern Europe**  
Telephone: 31(0)183-696969  
Fax: 31(0)183-629055  
E-mail: order@edc.katun.com













OEM PN	KATUN PN	DESCRIPTION	MODEL NO.	
<b>Feed/Delivery</b>				
4400 756530	43009693 	<b>Paper Feed Roller</b> Tire Only	1710, 2310, 2500, 3210	<i>Priced per Tire, sold in Bags of 10.</i>
4400 757810	43009697 	<b>Paper Pickup Roller</b> Tire Only	1710, 2310, 2500, 3210, KD- 1001, MY- 1001	<i>Priced per Tire, sold in Bags of 10.</i>
4402 818180	43011296 	<b>Lower Separation Pad</b>	1710, 2310, 2500, 3210, MY- 1001	<i>Priced per Separation Pad, sold in Boxes of 10.</i>
N/P/N	43011304 	<b>Feed Component Replacement Kit</b> Tire Only Kit Contains: • (1) Paper Feed Tire • (1) Lower Separation Pad • (2) Paper Pickup Tire	1710, 2310, 2500, 3210, MY- 1001	
4402 208960	43010056 	<b>Paper Feed Roller</b> Tire Only	1710, 2310, 2510, 3210, 4010, 4550, 5010, 5020, KD- 1001, MY- 1001	<i>Priced per Tire, sold in Bags of 10.</i>
4402 038470	43009693 	<b>Paper Feed Tire</b> Tire Only	2060, 2510, 2550, 2860, 3220, 3550, 3850 D, 4010, 4550, 5010, 5020, 5540, 5560, 6550, 6560, 7550, 7560, 7650, 7660, DP 2460, DP 4580, DP 5570, DP 6570, DP 8070, e-STUDIO 55, e-STUDIO 65, e-STUDIO 80	<i>Priced per Tire, sold in Bags of 10.</i>
4402 474100	43021590 	<b>Paper Feed Roller Kit</b> Kit Contains: • (1) Paper Feed Tire • (1) Separation Tire • (1) Paper Pickup Roller	2060, 2860, 2870, 3560, 3570, 4560, 4570, DP 2460	
4401 967330	43018878 	<b>Paper Pickup Roller</b>	2060, 2860, 2870, 3560, 3570, 4560, 4570, DP 2460, DP 2570, DP 3580	
4401 964410	43019948 	<b>Paper Feed Roller</b> Tire Only	2060, 2860, 2870, 3560, 3570, 4560, 4570, DP 2460, DP 2570, DP 3580, e-STUDIO 16, e-STUDIO 16 s, e-STUDIO 20, e-STUDIO 20 s, e-STUDIO 25, e-STUDIO 25 s, E-STUDIO 350, E-STUDIO 450, E-STUDIO 3511, E-STUDIO 4511, MD- 1009, MP- 1501, MY- 1015	<i>Priced per Tire, sold in Bags of 10.</i>
4401 964290	43019949 	<b>Separation Roller</b> Tire Only	2060, 2860, 2870, 3560, 3570, 4560, 4570, DP 2460, DP 2570, DP 3580, e-STUDIO 16, e-STUDIO 16 s, e-STUDIO 20, e-STUDIO 20 s, e-STUDIO 25, e-STUDIO 25 s, MD- 1009, MP- 1501	<i>Priced per Tire, sold in Bags of 10.</i>
4401 966510	43017818 	<b>Paper Feed Tire</b> Tire Only	2060, 2860, DP 2460, DP 3580	<i>Priced per Tire, sold in Bags of 10.</i>

OEM PN	KATUN PN	DESCRIPTION	MODEL NO.	
<b>Feed/Delivery</b>				
4401 964280	43019949 	<b>Separation Tire</b> Tire Only	2060, 2860, DP 2460, DP 3580, MP- 1501	<i>Priced per Tire, sold in Bags of 10.</i>
4401 964420	43019948 	<b>Paper Feed Tire</b> Tire Only	2060, 2860, DP 2460, DP 3580, MP- 1501	<i>Priced per Tire, sold in Bags of 10.</i>
4402 038400	43009692 	<b>Paper Pickup Roller</b> Tire Only	2510, 2550, 3220, 3550, 3850 D, 4010, 4550, 5010, 5020	<i>Priced per Tire, sold in Bags of 10.</i>
4402 038410	43009692 	<b>Paper Pickup Tire</b> Tire Only	2510, 2550, 3220, 3550, 3850 D, 4010, 4550, 5010, 5020	<i>Priced per Tire, sold in Bags of 10.</i>
4402 038420	43009690 	<b>Upper Paper Feed Roller</b> Tire Only	2510, 2550, 3220, 3550, 3850 D, 4010, 4550, 5010, 5020, 5540, 5560, 6550, 6560, 7550, 7560, 7650, 7660, DP 4580, DP 5570, DP 6570, DP 8070, e-STUDIO 55, e-STUDIO 65, e-STUDIO 80, MP- 4001, MR- 7	<i>Priced per Tire, sold in Bags of 10.</i>
4402 038480	43009696 	<b>Separation Roller</b> Tire Only Various Applications  Upper	2510, 2550, 3220, 3550, 3850 D, 4010, 4550, 5010, 5020, 5560, 7550, 7560, 7650, 7660  MD- 3, MD- 4	<i>Priced per Tire, sold in Bags of 10.</i>
4400 801560	43009965 	<b>Bypass Feed Roller</b> Tire Only	2510, 2550, 3220, 3550, 3850 D, 4010, 4550, 5010, 5020, BD 5610, BD 5620, BD 5910, BD 7610, BD 7720, BD 7910, BD 8411, BD 8412, BD 8510, BD 9100, BD 9110, BD 9230, BD 9240, ChromaTouch 1000	<i>Priced per Tire, sold in Bags of 10.</i>
4400 825750	43009697 	<b>Duplex Paper Pickup Roller</b> Tire Only	2510, 2550, 3220, 3550, 3850 D, 4010, 4550, 5020, 5540, 6550, 7550, 7560, 7650, 7660	<i>Priced per Tire, sold in Bags of 10.</i>
4402 038550	43009964 	<b>Lower Separation Roller</b> Tire Only Various Applications  Duplex	3850 D, KD- 1001, KD- 2001, KD- 2002, KD- 3005, MD- 3, MD- 4  2510, 2550, 3220, 3550, 4010, 4550, 5020	<i>Priced per Tire, sold in Bags of 10.</i>
N/P/N	43011795 	<b>ADD Feed Tire Replacement Kit</b> Kit Contains: • (2) Paper Pickup Tire • (1) Separation Tire • (1) Feed Tire	2510, 3220, 4010, 5010, 5020	
N/P/N	43011794 	<b>LCC Feed Tire Replacement Kit</b> Kit Contains: • (1) Paper Pickup Tire • (1) Separation Tire • (1) Paper Feed Tire	2510, 3220, 4010, 5010, 5020	

For use in  
**Toshiba**  
 Copiers

**Central/Eastern Europe**  
 Telephone: 31(0)183-696969  
 Fax: 31(0)183-629055  
 E-mail: order@edc.katun.com















OEM PN	KATUN PN	DESCRIPTION	MODEL NO.	
<b>Feed/Delivery</b>				
N/P/N	43011793 	<b>Feed Tire Replacement Kit</b> Kit Contains: • (1) Paper Feed Tire • (1) Paper Pickup Tire • (1) Separation Tire	2510, 3220, 4010, 5010, 5020	
4400 823830	43636693 	<b>Separation/Feed Tire</b> Tire Only	2510, 4010, 5010, 5020, BD 4910, BD 5910, BD 7910, BD 8510	<i>Priced per Tire, sold in Bags of 10.</i>
4402 260870	43012021 	<b>LCC Feed Roller Replacement Kit</b> Tire Only Kit Contains: • (1) Paper Feed Tire • (1) Separation Tire	3550, 3850 D, 4550	
4402 242910	43010819 	<b>Original Separation Roller</b> Tire Only	3850 D, 4550, 5010, 5020, 5540, MR- 3001, MR- 3003	
4402 243690	43016741 	<b>Original Pickup Roller</b> Tire Only	3850 D, 4550, 5010, 5020, 5540, MR- 3001, MR- 3003	<i>Priced per Tire, sold in Bags of 2.</i>
4402 241680	43016275 	<b>Separation Pad</b>	3850 D, 4550, 5540, MR- 3001, MR- 3003	<i>Priced per Pad, sold in Bags of 10.</i>
4408 690810	43014070 	<b>Original Feed Roller</b> Tire Only	4560, 4570, MR- 2008, MR- 3006	<i>Priced per Tire, sold in Bags of 4.</i>
4402 242900	43010818 	<b>Original Pickup Roller</b> Tire Only	5010, 5020, MR- 3001	
4401 773030	43012301 	<b>Separation Roller</b> Tire Only	5540, 5560, 6550, 6560, 7550, 7560, 7650, 7660	<i>Priced per Tire, sold in Bags of 10.</i>
4401 773010	43012854 	<b>Separation Roller</b> Tire Only	5540, 5560, 6550, 6560, 7550, 7560, 7650, 7660, MP- 4001	<i>Priced per Tire, sold in Bags of 10.</i>
4401 773040	43012301 	<b>Separation Tire</b> Tire Only	5540, 6550, 6560, 7550, 7560, 7650, 7660, DP 4580, DP 5570, DP 6570, DP 8070, e-STUDIO 55, e-STUDIO 65, e-STUDIO 80	<i>Priced per Tire, sold in Bags of 10.</i>
4401 773080	43019855 	<b>Paper Pickup Roller</b>	5540, 6550, 7550, 7560, 7650, 7660, DP 4580, DP 5570, DP 6570, DP 8070, e-STUDIO 55, e-STUDIO 65, e-STUDIO 80	
4401 791920	43011370 	<b>Original Feed Roller</b> Tire Only	6550, 6560, 7550, 7560, 7650, 7660	<i>Priced per Tire, sold in Bags of 5.</i>

OEM PN	KATUN PN	DESCRIPTION	MODEL NO.	
<b>Feed/Delivery</b>				
AF030006	43010496 	<b>Paper Pickup Roller</b> Tire Only	8050	<i>Priced per Tire, sold in Bags of 10.</i>
AF030015	43010496 	<b>Paper Pickup Roller</b> Tire Only	8050, MP- 3501	<i>Priced per Tire, sold in Bags of 10.</i>
N/P/N	43636641 	<b>Feed Tire Replacement Kit</b>  Kit Contains: <ul style="list-style-type: none"> <li>• (1) Separation/Feed Tire</li> <li>• (1) Paper Pickup Tire</li> <li>• (1) Separation/Feed Tire</li> </ul>	BD 4810, BD 4910, BD 5110, BD 5120, BD 5610, BD 5620, BD 5910, BD 7610, BD 7910, BD 8411, BD 8412, BD 8510, BD 9100, BD 9110, BD 9230, BD 9240	
4407 908870	43636670 	<b>Lower Separation Tire</b> Tire Only	BD 4810, BD 4910, BD 5110, BD 5120, BD 5610, BD 5620, BD 5910, BD 7610, BD 7910, BD 8411, BD 8412, BD 8510, MD- 2	<i>Priced per Tire, sold in Bags of 10.</i>
4400 834050	43636670 	<b>Separation Roller Assembly</b> Tire Only	BD 4810, BD 4910, BD 5110, BD 5120, BD 5910, BD 7610, BD 7720, BD 7910, BD 8510	<i>Priced per Tire, sold in Bags of 10.</i>
4408 305610	43636693 	<b>Separation/Feed Tire</b> Tire Only	BD 4810, BD 5110, BD 5120, BD 5610, BD 5620, BD 5910, BD 7610, BD 7720, BD 7910, BD 8411, BD 8412, BD 8510, BD 9100, BD 9110, BD 9230, BD 9240, MD- 2	<i>Priced per Tire, sold in Bags of 10.</i>
4407 907340	43636691 	<b>Paper Pickup Tire</b> Tire Only	BD 4810, BD 5110, BD 5120, BD 5610, BD 5620, BD 5910, BD 7610, BD 7720, BD 8411, BD 8412, BD 9100, BD 9110	<i>Priced per Tire, sold in Bags of 10.</i>
4407 908810	43009693 	<b>Upper Separation Roller</b> Tire Only	BD 4810, BD 5110, BD 5120, BD 5610, BD 5620, BD 5910, BD 7610, BD 7720, BD 8411, BD 8412, BD 9110, MD- 2	<i>Priced per Tire, sold in Bags of 10.</i>
4400 833130	43636691 	<b>Paper Pickup Tire</b> Tire Only	BD 4910, BD 5910, BD 7910, BD 8510, BD 9230, BD 9240, ChromaTouch 1000, MD- 3, MD- 4	<i>Priced per Tire, sold in Bags of 10.</i>
4407 906010	43009693 	<b>Paper Feed Roller</b> Tire Only	BD 5610, BD 5620, BD 8411, BD 8412	<i>Priced per Tire, sold in Bags of 10.</i>
4407 908900	43636670 	<b>Paper Feed Roller</b> Tire Only	BD 5610, BD 5620, BD 8411, BD 8412, MD- 2	<i>Priced per Tire, sold in Bags of 10.</i>
4408 505300	43009693 	<b>Upper Separation Roller</b> Tire Only	BD 9100, BD 9110, BD 9230, BD 9240	<i>Priced per Tire, sold in Bags of 10.</i>
4408 505960	43636670 	<b>Lower Separation Roller</b> Tire Only	BD 9100, BD 9110, BD 9230, BD 9240, ChromaTouch 1000	<i>Priced per Tire, sold in Bags of 10.</i>





For use in  
**Toshiba**  
 Copiers

**Central/Eastern Europe**  
 Telephone: 31(0)183-696969  
 Fax: 31(0)183-629055  
 E-mail: order@edc.katun.com









OEM PN	KATUN PN	DESCRIPTION	MODEL NO.	
<b>Feed/Delivery</b>				
4408 337870	43636670 	<b>Duplex Tray Feed Roller</b> Tire Only	BD 9110	<i>Priced per Tire, sold in Bags of 10.</i>
4406 342930	43020111 	<b>Pickup Roller</b> Tire Only	DP 4580, DP 5570, DP 6570, DP 8070, e-STUDIO 55, e-STUDIO 65, e-STUDIO 80	<i>Priced per Tire, sold in Bags of 10.</i>
4406 344170	43019936 	<b>Paper Feed Roller</b>	DP 4580, DP 5570, DP 6570, DP 8070, e-STUDIO 55, e-STUDIO 65, e-STUDIO 80	
4406 347620	43012301 	<b>Separation Roller</b> Tire Only	DP 4580, DP 5570, DP 6570, DP 8070, e-STUDIO 55, e-STUDIO 65, e-STUDIO 80	<i>Priced per Tire, sold in Bags of 10.</i>
4406 363050	43019801 	<b>Original Feed Roller</b>	DP 4580, DP 5570, DP 6570, DP 8070, e-STUDIO 55, e-STUDIO 65, e-STUDIO 80	
4406 363080	43019946 	<b>Original Feed-in Roller</b>	DP 4580, DP 5570, DP 6570, DP 8070, e-STUDIO 55, e-STUDIO 65, e-STUDIO 80	
4406 363530	43019947 	<b>Separation Pad</b>	DP 4580, DP 5570, DP 6570, DP 8070, e-STUDIO 55, e-STUDIO 65, e-STUDIO 80	
4406 347610	43012301 	<b>Separation Roller</b> Tire Only	DP 4580, DP 5570, DP 6570, DP 8070, e-STUDIO 55, e-STUDIO 65, e-STUDIO 80, E-STUDIO 550, E-STUDIO 650, E-STUDIO 810	<i>Priced per Tire, sold in Bags of 10.</i>
4406 361060	43019936 	<b>Duplex Paper Feed Roller</b>	DP 4580, DP 5570, DP 8070, e-STUDIO 55, e-STUDIO 65, e-STUDIO 80	
41330 506000	43023035 	<b>Paper Feed Roller</b> Tire Only	e-STUDIO 12, e-STUDIO 15, E-STUDIO 120, E-STUDIO 150, MY- 1019	<i>Priced per Tire, sold in Bags of 4.</i>
41330 540700	43016478 	<b>Manual Paper Feed Roller</b>	e-STUDIO 12, e-STUDIO 15, E-STUDIO 150, GD- 1100, MR- 2013, MR- 2014	
CGUMM0286FC31	43009690 	<b>Manual Paper Feed Tire</b> Tire Only	e-STUDIO 12, e-STUDIO 15, GD- 1100, MR- 2013	<i>Priced per Tire, sold in Bags of 10.</i>
CGUMM0288FC31	43014266 	<b>Manual Paper Pickup Tire</b> Tire Only	e-STUDIO 12, e-STUDIO 15, GD- 1100, MR- 2013	<i>Priced per Tire, sold in Bags of 10.</i>
41306 530000 <i>Final Inventory</i>	43021738 	<b>Transfer Roller Guide</b>	e-STUDIO 16, e-STUDIO 16 s, e-STUDIO 20, e-STUDIO 20 s, e-STUDIO 25, e-STUDIO 25 s	
ROLKIT16CST	43021589 	<b>Paper Feed Roller Kit</b>  Kit Contains: • (1) Paper Feed Tire • (1) Separation Tire • (1) Paper Pickup Roller	e-STUDIO 16, e-STUDIO 16 s, e-STUDIO 20, e-STUDIO 20 s, e-STUDIO 25, e-STUDIO 25 s	























OEM PN	KATUN PN	DESCRIPTION	MODEL NO.	
<b>Feed/Delivery</b>				
41306 719000	43020765 	<b>Paper Pickup Roller</b>	e-STUDIO 16, e-STUDIO 16 s, e-STUDIO 20, e-STUDIO 20 s, e-STUDIO 25, e-STUDIO 25 s, E-STUDIO 350, E-STUDIO 450, E-STUDIO 3511, E-STUDIO 4511, MY- 1015	
41319 632000	43018482 	<b>Paper Pickup Tire</b> Tire Only	e-STUDIO 28, e-STUDIO 35, e-STUDIO 45	<i>Priced per Tire, sold in Bags of 10.</i>
41319 658000	43018484 	<b>Paper Feed Tire 1</b> Tire Only	e-STUDIO 28, e-STUDIO 35, e-STUDIO 45	<i>Priced per Tire, sold in Bags of 10.</i>
41319 660000	43018483 	<b>Paper Feed Tire S</b> Tire Only	e-STUDIO 28, e-STUDIO 35, e-STUDIO 45	<i>Priced per Tire, sold in Bags of 10.</i>
44201 807000	43009690 	<b>Paper Pickup Roller</b> Tire Only	e-STUDIO 28, e-STUDIO 35, e-STUDIO 45	<i>Priced per Tire, sold in Bags of 10.</i>
ROLKIT1010	43020136 	<b>Paper Feed Roller Kit</b> Tire Only For KD 1010 Kit Contains: • (1) Paper Pickup Tire • (1) Separation/Feed Tire • (1) Paper Feed Tire	e-STUDIO 28, e-STUDIO 35, e-STUDIO 45	
A8061295	43017521 	<b>Paper Feed Belt</b>	E-STUDIO 900, E-STUDIO 1050	
A8061321	43017775 	<b>Paper Pickup Roller</b> Tire Only	E-STUDIO 900, E-STUDIO 1050	<i>Priced per Tire, sold in Bags of 10.</i>
A8592241	43022890 	<b>ADF Reverse Roller</b>	E-STUDIO 900, E-STUDIO 1050	
AF013005	43019799 	<b>Bottom Plate Friction Pad</b> Cork Type	E-STUDIO 900, E-STUDIO 1050	<i>Priced per Friction Pad, sold in Bags of 10.</i>
4402 474110	43021608 	<b>Paper Feed Roller Kit</b> Tire Only Kit Contains: • (2) Paper Feed Tire • (1) Separation Tire	MP- 1501	
4402 824250	43011373 	<b>Original Pickup Roller</b> Tire Only	MR- 2001	<i>Priced per Tire, sold in Bags of 10.</i>
4402 824260	43011373 	<b>Original Feed Tire</b> Tire Only	MR- 2001	<i>Priced per Tire, sold in Bags of 10.</i>

For use in  
**Toshiba**  
 Copiers

**Central/Eastern Europe**  
 Telephone: 31(0)183-696969  
 Fax: 31(0)183-629055  
 E-mail: order@edc.katun.com

OEM PN	KATUN PN	DESCRIPTION	MODEL NO.	
<b>Feed/Delivery</b>				
4402 824430	43011373 	<b>Original Feed Roller</b> Tire Only	MR- 2001	<i>Priced per Tire, sold in Bags of 10.</i>
4402 824440	43011373 	<b>Original Feed Tire</b> Tire Only	MR- 2001	<i>Priced per Tire, sold in Bags of 10.</i>
4400 786700	43019943 	<b>Original Pickup Roller</b> Ribbed Tire For Document Feeder	MR- 2002	<i>Priced per Pickup Roller, sold in Bags of 10.</i>
4408 692090	43022883 	<b>Separation Pad</b>	MR- 2008, MR- 3006, MR- 3006 A	<i>Priced per Separation Pad, sold in Bags of 10.</i>
5400-4301	43009202 	<b>Double Feed Prevention Roller</b> Tire Only	MR- 3004, MY- 1005	<i>Priced per Tire, sold in Bags of 10.</i>
396040320	43000146 	<b>Paper Feed Roller</b> Tire Only	MY- 1005	<i>Priced per Tire, sold in Bags of 10.</i>
540040562	43015378 	<b>Paper Feed Tire</b> Tire Only	MY- 1005	<i>Priced per Tire, sold in Bags of 10.</i>
25AA40011	43016268 	<b>Paper Feed Tire A</b> Tire Only	MY- 1005, MY- 3001	<i>Priced per Tire, sold in Bags of 10.</i>

OEM PN	KATUN PN	DESCRIPTION	MODEL NO.
<b>Filters</b>			
4402 843380	43013012 	<b>Exit Ozone Filter</b>	1340, 1350, 1360, 1370
4400 685600	43016860 	<b>Ozone Filter</b>	1550, 1560
4402 801280	43010893 	<b>Ozone Filter</b>	1650, 1710, 2050, 2310, 2500, 2540, 3210, 3240
4400 911480	43013013 	<b>Exit Ozone Filter</b>	1650, 2050, 2540, 3240
4402 801870 <i>Final Inventory</i>	43010196 	<b>Ozone Filter</b>	1710, 2310, 2500, 3210
4401 941710	43016647 	<b>Exhaust Fan Ozone Filter</b>	2060, 2860, 2870, 3560, 3570
4402 211770	43010670 	<b>Ozone Filter</b>	2510, 2550, 3220, 3550, 3850 D, 4010, 4550
4402 090090	43012824 	<b>Exit Ozone Filter</b>	2510, 2550, 3220, 3550, 4010, 4550, 5010, 5020
4402 203280	43012824 	<b>Ozone Filter</b>	2510, 2550, 3220, 3550, 4010, 4550, 5010, 5020
4402 431470	43018028 	<b>Exit Ozone Filter</b>	4560, 4570
4401 765160	43014262 	<b>Exit Ozone Filter</b>	5540, 6550
4401 906250	43015483 	<b>Developer Filter</b>	5560, 6560, 7550, 7560, 7650, 7660
4408 665150	43016859 	<b>Ozone Filter</b>	DP 2460, DP 2570
4408 665160	43016861 	<b>Ozone Filter</b>	DP 2460, DP 2570
4402 935760	43020982 	<b>Ozone Filter</b>	DP 3580
4402 935980	43020982 	<b>Ozone Filter</b>	DP 3580
4402 941840	43021716 	<b>Developer Filter</b>	DP 3580
4406 310920	43020063 	<b>Ozone Filter</b>	DP 4580, DP 5570, DP 6570, DP 8070, e-STUDIO 55, e-STUDIO 65, e-STUDIO 80
4406 334900	43015483 	<b>Developer Filter</b>	DP 4580, DP 5570, DP 6570, DP 8070, e-STUDIO 55, e-STUDIO 65, e-STUDIO 80
44203 925000	43021388 	<b>Ozone Filter</b>	e-STUDIO 28, e-STUDIO 35, e-STUDIO 45
AA012113	43020164 	<b>Pressure Release Filter</b> Center	E-STUDIO 900, E-STUDIO 1050

For use in  
**Toshiba**  
Copiers

**Central/Eastern Europe**  
Telephone: 31(0)183-696969  
Fax: 31(0)183-629055  
E-mail: [order@edc.katun.com](mailto:order@edc.katun.com)



















OEM PN	KATUN PN	DESCRIPTION	MODEL NO.
-----------	-------------	-------------	--------------

---

**Filters**













---





AA012114	43020163 	<b>Pressure Release Filter</b> Front	E-STUDIO 900, E-STUDIO 1050
----------	---	---	-----------------------------

OEM PN	KATUN PN	DESCRIPTION	MODEL NO.
<b>Fuser Cleaning</b>			
SR 1550 H	43014097 	<b>Fuser Cleaning Roller</b>	1550, 1560
4400 919620	43010379 	<b>Fuser Roller Cleaning Felt</b>	1650, 2050, 2540
SR 3210 H	43011225 	<b>Fuser Cleaning Roller</b>	1650, 2050, 2540, 3210
SR 2550 H	43011226 	<b>Fuser Cleaning Roller FIBRA™ II</b> Enhanced fuser cleaning efficiency.	1710, 2310, 2500, 2510, 2550
SR 2550 H	43014992 	<b>Fuser Cleaning Roller</b>	1710, 2310, 2500, 2510, 2550
SR2510H	43011226 	<b>Fuser Cleaning Roller FIBRA™ II</b> Enhanced fuser cleaning efficiency.	1710, 2310, 2500, 2510, 2550
SR 2060 H	43015411 	<b>Fuser Cleaning Roller</b>	2060, 2860, 2870, DP 2460, DP 2570
SR 5020 H	43011964 	<b>Fuser Cleaning Roller FIBRA™ II</b> Extended fuser component life.	3220, 3550, 3850 D, 4010, 4550, 5010, 5020
SR 5020 H	43019539 	<b>Fuser Cleaning Roller</b>	3220, 3550, 3850 D, 4010, 4550, 5010, 5020
SR 3240 H <i>Final Inventory</i>	43013094 	<b>Fuser Cleaning Roller</b>	3240
SR 3560 H	43017127 	<b>Fuser Cleaning Roller</b>	3560, 3570, DP 3580
B 4560 H	43021321 	<b>Fuser Cleaning Roller</b>	4560, 4570
SR 4560 H	43016723 	<b>Oil Supply Roller</b>	4560, 4570
SR 5540 L	43012357 	<b>Lower Fuser Cleaning Roller</b>	5540
B 6550 H	43012358 	<b>Fuser Cleaning Roller</b>	5540, 5560, 6550, 6560, 7550, 7560, 7650, 7660
SR 6550 H	43014462 	<b>Fuser Cleaning Roller</b> Various Applications Upper	5560, 6550, 6560 5540, 7550, 7560, 7650, 7660
SR 7550 L	43015446 	<b>Lower Fuser Cleaning Roller</b>	5560, 6560, 7550, 7560, 7650, 7660
AE040007 <i>Final Inventory</i>	43011584 	<b>Oil Supply Roller FIBRA™ II</b> Enhanced fuser cleaning efficiency.	8050
B 3580 H	43021700 	<b>Fuser Cleaning Roller</b>	DP 3580

For use in  
**Toshiba**  
 Copiers







**Central/Eastern Europe**  
 Telephone: 31(0)183-696969  
 Fax: 31(0)183-629055  
 E-mail: order@edc.katun.com





OEM PN	KATUN PN	DESCRIPTION	MODEL NO.
<b>Fuser Cleaning</b>			
4409 892790	43018378 	<b>Upper Fuser Cleaning Roller</b>	DP 4580, DP 5570, DP 6570, DP 8070, e-STUDIO 55, e-STUDIO 65, e-STUDIO 80
SR 6570 H	43018042 	<b>Oil Supply Roller</b>	DP 4580, DP 5570, DP 6570, DP 8070, e-STUDIO 55, e-STUDIO 65, e-STUDIO 80, E-STUDIO 550, E-STUDIO 650, E-STUDIO 810
SR 6570 L	43018043 	<b>Lower Oil Supply Roller</b>	DP 4580, DP 5570, DP 6570, DP 8070, e-STUDIO 55, e-STUDIO 65, e-STUDIO 80, E-STUDIO 550, E-STUDIO 650, E-STUDIO 810
4409 893740	43018379 	<b>Lower Fuser Cleaning Roller</b>	DP 4580, DP 5570, DP 6570, DP 8070, E-STUDIO 550, E-STUDIO 650, E-STUDIO 810
B 8070 L	43018379 	<b>Lower Fuser Cleaning Roller</b>	DP 4580, DP 5570, DP 6570, DP 8070, E-STUDIO 550, E-STUDIO 650, E-STUDIO 810
B 6570 L	43018379 	<b>Lower Fuser Cleaning Roller</b>	DP 4580, DP 5570, DP 6570, e-STUDIO 55, e-STUDIO 65, e-STUDIO 80
41304 523000	43019883 	<b>Fuser Cleaning Roller</b>	e-STUDIO 16, e-STUDIO 16 s, e-STUDIO 20, e-STUDIO 20 s, e-STUDIO 25, e-STUDIO 25 s
44202 985000	43019988 	<b>Lower Fuser Cleaning Roller</b>	e-STUDIO 28, e-STUDIO 35, e-STUDIO 45, E-STUDIO 350, E-STUDIO 450
CW 6510	43023549 	<b>Cleaning Web</b>	E-STUDIO 550, E-STUDIO 650, E-STUDIO 810
AE040039	43023032 	<b>Oil Supply Cleaning Roller</b>	E-STUDIO 900, E-STUDIO 1050
AE042042	43018610 	<b>Lower Fuser Cleaning Roller</b>	E-STUDIO 900, E-STUDIO 1050
AE045047	43023288 	<b>Cleaning Web</b>	E-STUDIO 900, E-STUDIO 1050

OEM PN	KATUN PN	DESCRIPTION	MODEL NO.
<b>Kits</b>			
4409 892570	43022570 	<b>60K PM Kit</b> Kit Contains: <ul style="list-style-type: none"> <li>• (3) Corona Wire</li> <li>• (1) Fuser Cleaning Roller</li> <li>• (1) Drum Cleaning Blade</li> <li>• (1) Charge Corona Grid</li> <li>• (1) Ozone Filter</li> <li>• (2) Paper Pickup/Feed Roller</li> <li>• (1) Black Developer</li> <li>• (1) Fuser Roller Cleaning Blade</li> <li>• (6) Fuser Picker Finger</li> <li>• (1) Separation Roller</li> </ul>	1550, 1560
4409 892590	43015460 	<b>60K PM Kit</b> Kit Contains: <ul style="list-style-type: none"> <li>• (1) Black Developer</li> <li>• (1) Corona Wire</li> <li>• (2) Corona Wire</li> <li>• (1) Drum Cleaning Blade</li> <li>• (1) Exit Ozone Filter</li> <li>• (1) Fuser Cleaning Roller</li> <li>• (1) Fuser Roller Cleaning Felt</li> <li>• (1) Manual Feed Tire</li> <li>• (1) Ozone Filter</li> <li>• (2) Paper Pickup Tire</li> <li>• (1) Separation Pad</li> <li>• (6) Upper Picker Finger</li> </ul>	1650, 2050, 2540
N/P/N	43015619 	<b>Feed Tire Replacement Kit</b> Tire Only Kit Contains: <ul style="list-style-type: none"> <li>• (1) Paper Feed Tire</li> <li>• (2) Paper Pickup Tire</li> <li>• (1) Separation Pad</li> </ul>	1650, 2050, 2540, 3240
4409 892580	43015461 	<b>60K PM Kit</b> Kit Contains: <ul style="list-style-type: none"> <li>• (1) Black Developer</li> <li>• (1) Corona Wire</li> <li>• (2) Corona Wire</li> <li>• (1) Drum Cleaning Blade</li> <li>• (1) Fuser Cleaning Roller</li> <li>• (1) Fuser Roller Cleaning Felt</li> <li>• (1) Lower Separation Pad</li> <li>• (1) Ozone Filter</li> <li>• (1) Ozone Filter</li> <li>• (1) Paper Feed Tire</li> <li>• (2) Paper Pickup Tire</li> <li>• (6) Upper Picker Finger</li> </ul>	1710, 2310, 2500

For use in  
**Toshiba**  
 Copiers



**Central/Eastern Europe**  
 Telephone: 31(0)183-696969  
 Fax: 31(0)183-629055  
 E-mail: order@edc.katun.com

OEM PN	KATUN PN	DESCRIPTION	MODEL NO.
<b>Kits</b>			
N/P/N	43011304 	<b>Feed Component Replacement Kit</b> Tire Only Kit Contains: <ul style="list-style-type: none"> <li>• (1) Paper Feed Tire</li> <li>• (1) Lower Separation Pad</li> <li>• (2) Paper Pickup Tire</li> </ul>	1710, 2310, 2500, 3210, MY- 1001
4409 890730	43018869 	<b>80K PM Kit</b> Kit Contains: <ul style="list-style-type: none"> <li>• (1) Drum Cleaning Blade</li> <li>• (1) Fuser Cleaning Roller</li> <li>• (3) Drum Picker Finger</li> <li>• (1) Exhaust Fan Ozone Filter</li> <li>• (3) Corona Wire</li> <li>• (1) Charge Corona Grid</li> <li>• (6) Upper Picker Finger</li> <li>• (1) Paper Pickup Roller</li> <li>• (2) Paper Feed Roller</li> <li>• (1) Separation Roller</li> <li>• (1) Black Developer</li> </ul>	2060, 2860, 2870
4402 474100	43021590 	<b>Paper Feed Roller Kit</b> Kit Contains: <ul style="list-style-type: none"> <li>• (1) Paper Feed Tire</li> <li>• (1) Separation Tire</li> <li>• (1) Paper Pickup Roller</li> </ul>	2060, 2860, 2870, 3560, 3570, 4560, 4570, DP 2460
4409 892060	43015213 	<b>60K PM Kit</b> Kit Contains: <ul style="list-style-type: none"> <li>• (1) Black Developer</li> <li>• (3) Corona Wire</li> <li>• (1) Drum Cleaning Blade</li> <li>• (1) Fuser Cleaning Roller</li> <li>• (1) Paper Feed Tire</li> <li>• (1) Ozone Filter</li> <li>• (1) Ozone Filter</li> <li>• (1) Separation Tire</li> <li>• (1) Paper Pickup Tire</li> </ul>	2510, 2550
N/P/N	43011795 	<b>ADD Feed Tire Replacement Kit</b> Kit Contains: <ul style="list-style-type: none"> <li>• (2) Paper Pickup Tire</li> <li>• (1) Separation Tire</li> <li>• (1) Feed Tire</li> </ul>	2510, 3220, 4010, 5010, 5020
N/P/N	43011794 	<b>LCC Feed Tire Replacement Kit</b> Kit Contains: <ul style="list-style-type: none"> <li>• (1) Paper Pickup Tire</li> <li>• (1) Separation Tire</li> <li>• (1) Paper Feed Tire</li> </ul>	2510, 3220, 4010, 5010, 5020

OEM PN	KATUN PN	DESCRIPTION	MODEL NO.
<b>Kits</b>			
N/P/N	43011793 	<b>Feed Tire Replacement Kit</b> Kit Contains: <ul style="list-style-type: none"> <li>• (1) Paper Feed Tire</li> <li>• (1) Paper Pickup Tire</li> <li>• (1) Separation Tire</li> </ul>	2510, 3220, 4010, 5010, 5020
4409 892080	43015214 	<b>60K PM Kit</b> Kit Contains: <ul style="list-style-type: none"> <li>• (1) Black Developer</li> <li>• (3) Corona Wire</li> <li>• (1) Drum Cleaning Blade</li> <li>• (1) Fuser Cleaning Roller</li> <li>• (1) Paper Feed Tire</li> <li>• (1) Ozone Filter</li> <li>• (1) Ozone Filter</li> <li>• (1) Separation Tire</li> <li>• (1) Paper Pickup Tire</li> </ul>	3220, 4010
4409 892070	43015463 	<b>80K PM Kit</b> Kit Contains: <ul style="list-style-type: none"> <li>• (1) Black Developer</li> <li>• (1) Corona Wire</li> <li>• (1) Corona Wire Cleaning Pad</li> <li>• (1) Corona Wire Cleaning Pad</li> <li>• (1) Drum Cleaning Blade</li> <li>• (1) Fuser Cleaning Roller</li> <li>• (1) Paper Feed Tire</li> <li>• (1) Ozone Filter</li> <li>• (1) Ozone Filter</li> <li>• (2) Corona Wire</li> <li>• (1) Separation Tire</li> <li>• (1) Upper Fuser Roller Cleaning Blade</li> <li>• (1) Paper Pickup Tire</li> <li>• (6) Upper Picker Finger</li> </ul>	3550
4402 260870	43012021 	<b>LCC Feed Roller Replacement Kit</b> Tire Only Kit Contains: <ul style="list-style-type: none"> <li>• (1) Paper Feed Tire</li> <li>• (1) Separation Tire</li> </ul>	3550, 3850 D, 4550
4409 891900	43017177 	<b>120K PM Kit</b> Kit Contains: <ul style="list-style-type: none"> <li>• (1) Black Developer</li> <li>• (1) Drum Cleaning Blade</li> <li>• (1) Fuser Cleaning Roller</li> <li>• (3) Drum Picker Finger</li> <li>• (1) Exhaust Fan Ozone Filter</li> <li>• (3) Corona Wire</li> <li>• (1) Charge Corona Grid</li> <li>• (6) Upper Picker Finger</li> </ul>	3560, 3570

For use in  
**Toshiba**  
 Copiers

**Central/Eastern Europe**  
 Telephone: 31(0)183-696969  
 Fax: 31(0)183-629055  
 E-mail: order@edc.katun.com

OEM PN	KATUN PN	DESCRIPTION	MODEL NO.
<b>Kits</b>			
4409 892090	43015404 	<b>80K PM Kit</b> Kit Contains: <ul style="list-style-type: none"> <li>• (1) Black Developer</li> <li>• (1) Corona Wire</li> <li>• (1) Corona Wire Cleaner</li> <li>• (1) Corona Wire Cleaning Pad</li> <li>• (1) Corona Wire Cleaning Pad</li> <li>• (1) Drum Cleaning Blade</li> <li>• (1) Fuser Cleaning Roller</li> <li>• (1) Paper Feed Tire</li> <li>• (1) Ozone Filter</li> <li>• (1) Ozone Filter</li> <li>• (2) Corona Wire</li> <li>• (1) Separation Tire</li> <li>• (1) Paper Pickup Tire</li> <li>• (6) Upper Picker Finger</li> </ul>	4550
4409 891910	43017178 	<b>160K PM Kit</b> Kit Contains: <ul style="list-style-type: none"> <li>• (1) Black Developer</li> <li>• (1) Drum Cleaning Blade</li> <li>• (1) Fuser Cleaning Roller</li> <li>• (3) Drum Picker Finger</li> <li>• (1) Exit Ozone Filter</li> <li>• (3) Corona Wire</li> <li>• (1) Charge Corona Grid</li> <li>• (6) Upper Picker Finger</li> <li>• (1) Oil Supply Roller</li> </ul>	4560, 4570
4409 892100	43015405 	<b>100K PM Kit</b> Kit Contains: <ul style="list-style-type: none"> <li>• (1) Black Developer</li> <li>• (3) Corona Wire</li> <li>• (1) Corona Wire</li> <li>• (1) Corona Wire</li> <li>• (1) Corona Wire Cleaner</li> <li>• (1) Corona Wire Cleaning Pad</li> <li>• (1) Corona Wire Cleaning Pad</li> <li>• (1) Corona Wire Cleaning Pad</li> <li>• (1) Drum Cleaning Blade</li> <li>• (1) Exit Ozone Filter</li> <li>• (1) Fuser Cleaning Roller</li> <li>• (1) Fuser Cleaning Roller</li> <li>• (1) Lower Fuser Cleaning Roller</li> <li>• (1) Paper Feed Tire</li> <li>• (1) Separation Tire</li> <li>• (1) Paper Pickup Tire</li> </ul>	5540

OEM PN	KATUN PN	DESCRIPTION	MODEL NO.
-----------	-------------	-------------	--------------





### Kits

4409 891170	43017179 	<b>200K PM Kit</b> Kit Contains: <ul style="list-style-type: none"> <li>• (1) Upper Paper Feed Roller</li> <li>• (1) Paper Feed Roller</li> <li>• (3) Corona Wire</li> <li>• (1) Fuser Cleaning Roller</li> <li>• (1) Separation Roller</li> <li>• (1) Corona Wire</li> <li>• (1) Fuser Cleaning Roller</li> <li>• (1) Corona Wire</li> <li>• (1) Corona Wire Cleaning Pad</li> <li>• (1) Drum Cleaning Blade</li> <li>• (1) Lower Fuser Cleaning Roller</li> <li>• (1) Developer Filter</li> <li>• (1) Charge Corona Grid</li> <li>• (1) Corona Wire Cleaning Pad</li> <li>• (1) Black Developer</li> <li>• (1) Drum Cleaning Brush</li> </ul>	5560, 6560
4409 892730	43015406 	<b>100K PM Kit</b> Kit Contains: <ul style="list-style-type: none"> <li>• (1) Black Developer</li> <li>• (3) Corona Wire</li> <li>• (1) Corona Wire</li> <li>• (1) Corona Wire</li> <li>• (1) Corona Wire Cleaner</li> <li>• (1) Corona Wire Cleaning Pad</li> <li>• (1) Corona Wire Cleaning Pad</li> <li>• (1) Corona Wire Cleaning Pad</li> <li>• (1) Drum Cleaning Blade</li> <li>• (1) Exit Ozone Filter</li> <li>• (1) Fuser Cleaning Roller</li> <li>• (1) Fuser Cleaning Roller</li> <li>• (1) Lower Fuser Roller Cleaning Felt</li> <li>• (1) Paper Feed Tire</li> <li>• (1) Separation Tire</li> <li>• (1) Paper Pickup Tire</li> </ul>	6550







For use in  
**Toshiba**  
 Copiers





**Central/Eastern Europe**  
 Telephone: 31(0)183-696969  
 Fax: 31(0)183-629055  
 E-mail: order@edc.katun.com

OEM PN	KATUN PN	DESCRIPTION	MODEL NO.
<b>Kits</b>			
PM6550	43015406 	<b>100K PM Kit</b> Kit Contains: <ul style="list-style-type: none"> <li>• (1) Black Developer</li> <li>• (3) Corona Wire</li> <li>• (1) Corona Wire</li> <li>• (1) Corona Wire</li> <li>• (1) Corona Wire Cleaner</li> <li>• (1) Corona Wire Cleaning Pad</li> <li>• (1) Corona Wire Cleaning Pad</li> <li>• (1) Corona Wire Cleaning Pad</li> <li>• (1) Drum Cleaning Blade</li> <li>• (1) Exit Ozone Filter</li> <li>• (1) Fuser Cleaning Roller</li> <li>• (1) Fuser Cleaning Roller</li> <li>• (1) Lower Fuser Roller Cleaning Felt</li> <li>• (1) Paper Feed Tire</li> <li>• (1) Separation Tire</li> <li>• (1) Paper Pickup Tire</li> </ul>	6550
N/P/N	43636641 	<b>Feed Tire Replacement Kit</b> Kit Contains: <ul style="list-style-type: none"> <li>• (1) Separation/Feed Tire</li> <li>• (1) Paper Pickup Tire</li> <li>• (1) Separation/Feed Tire</li> </ul>	BD 4810, BD 4910, BD 5110, BD 5120, BD 5610, BD 5620, BD 5910, BD 7610, BD 7910, BD 8411, BD 8412, BD 8510, BD 9100, BD 9110, BD 9230, BD 9240
4409 891180	43020134 	<b>80K PM Kit</b> Kit Contains: <ul style="list-style-type: none"> <li>• (2) Corona Wire</li> <li>• (1) Fuser Cleaning Roller</li> <li>• (6) Upper Picker Finger</li> <li>• (1) Paper Pickup Roller</li> <li>• (2) Ozone Filter</li> <li>• (3) Drum Picker Finger</li> <li>• (1) Drum Cleaning Blade</li> <li>• (2) Paper Feed Roller</li> <li>• (1) Separation Roller</li> <li>• (1) Black Developer</li> <li>• (2) Corona Wire</li> </ul>	DP 2460, DP 2570
4409 892550	43021737 	<b>110K PM Kit</b> Kit Contains: <ul style="list-style-type: none"> <li>• (4) Corona Wire</li> <li>• (6) Upper Picker Finger</li> <li>• (2) Fuser Cleaning Roller</li> <li>• (1) Drum Cleaning Blade</li> <li>• (1) Black Developer</li> <li>• (2) Ozone Filter</li> <li>• (1) Developer Filter</li> </ul>	DP 3580



OEM PN	KATUN PN	DESCRIPTION	MODEL NO.
<b>Kits</b>			
4408 850650	43021858 	<b>400K PM Kit</b> Kit Contains: <ul style="list-style-type: none"> <li>• (1) Corona Wire</li> <li>• (1) Charge Corona Grid</li> <li>• (1) Transfer Belt</li> <li>• (1) Drum Cleaning Blade</li> <li>• (1) Transfer Belt Cleaning Blade</li> <li>• (2) Drum Picker Finger</li> <li>• (1) Transfer Charging Roller</li> <li>• (1) Transfer Belt Cleaning Brush</li> <li>• (1) Drum Cleaning Brush</li> <li>• (1) Cleaning Pad</li> <li>• (1) Black Developer</li> </ul> Various Applications	DP 8070 DP 4580, DP 5570, e-STUDIO 55 DP 6570, e-STUDIO 65, e-STUDIO 80
4408 850720	43019739 	<b>Fuser Unit PM Kit</b> Kit Contains: <ul style="list-style-type: none"> <li>• (6) Upper Picker Finger</li> <li>• (1) Oil Supply Roller</li> <li>• (1) Lower Oil Supply Roller</li> <li>• (1) Lower Pressure Roller</li> <li>• (1) Upper Fuser Cleaning Roller</li> <li>• (1) Lower Fuser Cleaning Roller</li> <li>• (1) Upper Fuser Roller</li> </ul> Various Applications	DP 8070, e-STUDIO 80 DP 4580, DP 5570, e-STUDIO 55 DP 6570, e-STUDIO 65
4406 368500	43020102 	<b>Machine PM Kit</b> Kit Contains: <ul style="list-style-type: none"> <li>• (1) Upper Paper Feed Roller</li> <li>• (1) Paper Feed Roller</li> <li>• (1) Separation Tire</li> <li>• (1) Developer Filter</li> <li>• (1) Ozone Filter</li> </ul> Various Applications	DP 4580 DP 5570, e-STUDIO 55 DP 6570, e-STUDIO 65
4406 368550	43020857 	<b>Document Feeder PM Kit</b> Kit Contains: <ul style="list-style-type: none"> <li>• (1) Original Document Feed Belt</li> <li>• (1) Original Feed Roller</li> <li>• (1) Original Feed-in Roller</li> <li>• (1) Separation Pad</li> </ul> Various Applications	DP 4580 DP 5570, e-STUDIO 55 DP 6570, e-STUDIO 65













OEM PN	KATUN PN	DESCRIPTION	MODEL NO.
<b>Kits</b>			
DEV-KIT-3500	43021577 	<b>Developer PM Kit</b> Kit Contains: <ul style="list-style-type: none"> <li>• (3) Corona Wire</li> <li>• (1) Drum Cleaning Blade</li> <li>• (1) Charge Corona Grid</li> <li>• (1) Ozone Filter</li> <li>• (3) Drum Picker Finger</li> <li>• (1) Black Developer</li> </ul>	e-STUDIO 28, e-STUDIO 35, e-STUDIO 45
FU-KIT-3500	43022697 	<b>Fuser Unit PM Kit</b> Kit Contains: <ul style="list-style-type: none"> <li>• (1) Lower Fuser Cleaning Roller</li> <li>• (1) Upper Fuser Roller</li> <li>• (1) Lower Pressure Roller</li> <li>• (6) Upper Picker Finger</li> </ul>	e-STUDIO 28, e-STUDIO 35, e-STUDIO 45
ROLKIT1010	43020136 	<b>Paper Feed Roller Kit</b> Tire Only For KD 1010 Kit Contains: <ul style="list-style-type: none"> <li>• (1) Paper Pickup Tire</li> <li>• (1) Separation/Feed Tire</li> <li>• (1) Paper Feed Tire</li> </ul>	e-STUDIO 28, e-STUDIO 35, e-STUDIO 45
4402 474110	43021608 	<b>Paper Feed Roller Kit</b> Tire Only Kit Contains: <ul style="list-style-type: none"> <li>• (2) Paper Feed Tire</li> <li>• (1) Separation Tire</li> </ul>	MP- 1501

For use in  
**Toshiba**  
Copiers

**Central/Eastern Europe**  
Telephone: 31(0)183-696969  
Fax: 31(0)183-629055  
E-mail: [order@edc.katun.com](mailto:order@edc.katun.com)

OEM PN	KATUN PN	DESCRIPTION	MODEL NO.
<b>Lamps</b>			
4406 380120	43023159 	<b>Heater Lamp</b> 230V 600W	DP 4580, DP 5570, DP 6570, DP 8070, e-STUDIO 55, e-STUDIO 65, e-STUDIO 80

OEM PN	KATUN PN	DESCRIPTION	MODEL NO.
<b>Memory Upgrades</b>			
KR4004	43018438 	<b>Memory Upgrade Board- 4 MB</b> Printer Controller Memory	DP 1250, DP 1450, DP 1570, DP 1570 F, DP 1870 F
KR4016	43018436 	<b>Memory Upgrade Board- 16 MB</b> Printer Controller Memory	DP 1250, DP 1450, DP 1570, DP 1570 F, DP 1870 F
19082110	43018415 	<b>Memory Upgrade Board- 2 MB</b> Copier Memory	DP 1570, DP 1570 F, DP 1870 F
19082120	43018413 	<b>Memory Upgrade Board- 4 MB</b> Copier Memory	DP 1570, DP 1570 F, DP 1870 F
19082130	43018414 	<b>Memory Upgrade Board- 8 MB</b> Copier Memory	DP 1570, DP 1570 F, DP 1870 F
KR3012	43018431 	<b>Memory Upgrade Board- 4 MB</b> Copier Memory	DP 1570, DP 1570 F, DP 1870 F
KR3013	43018432 	<b>Memory Upgrade Board- 8 MB</b> Copier Memory	DP 1570, DP 1570 F, DP 1870 F
KR3007	43018440 	<b>Memory Upgrade Board- 8 MB</b> Printer Controller Memory	DP 2460, DP 2570
KR7013	43017661 	<b>Memory Upgrade Board- 32 MB</b> Copier Memory	DP 2570, DP 3580
GC1110	43020038 	<b>Memory Upgrade Board- 64 MB</b> Printer Memory Upgrade	GA- 1031

For current memory upgrade pricing, visit our on-line catalogue at [www.katun.com](http://www.katun.com) or contact your customer service representative.

For use in  
**Toshiba**  
Copiers

**Central/Eastern Europe**  
Telephone: 31(0)183-696969  
Fax: 31(0)183-629055  
E-mail: [order@edc.katun.com](mailto:order@edc.katun.com)

OEM PN	KATUN PN	DESCRIPTION	MODEL NO.
-----------	-------------	-------------	--------------

---

**Miscellaneous**











---

4402 810660	43022030 	Thermistor Bracket	1710
-------------	---	--------------------	------

OEM PN	KATUN PN	DESCRIPTION	MODEL NO.	
<b>Photoreceptors</b>				
OD1210	43502772 	<b>OPC Drum</b> 12 Drums per Master Carton	1210	<i>Priced per Drum, sold per Drum.</i>
SD 61M	43502719 	<b>SeTe Drum</b> 6 Drums per Master Carton	1310, BD 3810, BD 3910	<i>Priced per Drum, sold per Drum.</i>
OD1350	43012747 	<b>OPC Drum</b> 50 Drums per Master Carton	1340, 1350, 1360, 1370	<i>Priced per Drum, sold per Drum.</i>
OD1550	43015361 	<b>OPC Drum</b> 12 Drums per Master Carton	1550, 1560	<i>Priced per Drum, sold per Drum.</i>
OD1710	43015316 	<b>OPC Drum</b> 20 Drums per Master Carton	1650, 1710, 2050, 2310, 2500, 2540	<i>Priced per Drum, sold per Drum.</i>
OD2060	43016774 	<b>OPC Drum</b> 12 Drums per Master Carton	2060, 2860, 2870	<i>Priced per Drum, sold per Drum.</i>
OD2060	43017259	<b>OPC Drum Original</b>	2060, 2860, 2870	
OD2510	43000931 	<b>OPC Drum</b> 12 Drums per Master Carton	2510, 2550	<i>Priced per Drum, sold per Drum.</i>
OD3210	43015316 	<b>OPC Drum</b> 20 Drums per Master Carton	3210, 3240	<i>Priced per Drum, sold per Drum.</i>
OD4010	43000934 	<b>OPC Drum</b> 12 Drums per Master Carton	3220, 3550, 4010	<i>Priced per Drum, sold per Drum.</i>
OD3560	43016774 	<b>OPC Drum</b> 12 Drums per Master Carton	3560, 3570	<i>Priced per Drum, sold per Drum.</i>
OD4550	43012416 	<b>OPC Drum</b> 12 Drums per Master Carton	4550	<i>Priced per Drum, sold per Drum.</i>
OD4560	43016776 	<b>OPC Drum</b> 12 Drums per Master Carton	4560, 4570	<i>Priced per Drum, sold per Drum.</i>
SD 87L	43502717 	<b>As2Se3 Drum</b> 6 Drums per Master Carton	5010, 5020, BD 9100, BD 9110, BD 9230, BD 9240	<i>Priced per Drum, sold per Drum.</i>
SD5540	43015976 	<b>As2Se3 Drum</b> 6 Drums per Master Carton	5540	<i>Priced per Drum, sold per Drum.</i>





For use in  
**Toshiba**  
Copiers

**Central/Eastern Europe**  
Telephone: 31(0)183-696969  
Fax: 31(0)183-629055  
E-mail: order@edc.katun.com

OEM PN	KATUN PN	DESCRIPTION	MODEL NO.	
<b>Photoreceptors</b>				
OD6560	43015362 	<b>OPC Drum</b> 12 Drums per Master Carton	5560, 6560	<i>Priced per Drum, sold per Drum.</i>
SD6550	43015976 	<b>As2Se3 Drum</b> 6 Drums per Master Carton	6550	<i>Priced per Drum, sold per Drum.</i>
SD7550	43015976 	<b>As2Se3 Drum</b> 6 Drums per Master Carton	7550, 7560, 7650, 7660	<i>Priced per Drum, sold per Drum.</i>
SD9050	43012412 	<b>As2Se3 Drum</b> This drum is packaged for use in Konica, but is approved for use in these Toshiba models. 6 Drums per Master Carton	9260	<i>Priced per Drum, sold per Drum.</i>
OD 600S	43502772 	<b>OPC Drum</b> 12 Drums per Master Carton	BD 2810	<i>Priced per Drum, sold per Drum.</i>
SD 81S	43502710 	<b>SeTe Drum</b> 6 Drums per Master Carton	BD 3301, BD 4111, BD 4121	<i>Priced per Drum, sold per Drum.</i>
SD 83L	43502716 	<b>SeTe Drum</b> 6 Drums per Master Carton	BD 4810, BD 5610, BD 5620, BD 8411, BD 8412	<i>Priced per Drum, sold per Drum.</i>
SD 86L	43502716 	<b>SeTe Drum</b> 6 Drums per Master Carton	BD 4910, BD 5110, BD 5120, BD 5910, BD 7610, BD 7720, BD 7910	<i>Priced per Drum, sold per Drum.</i>
OD2460	43018453 	<b>OPC Drum</b> 12 Drums per Master Carton	DP 2460, DP 2570, DP 3580	<i>Priced per Drum, sold per Drum.</i>
OD6570	43022024 	<b>OPC Drum</b> 6 Drums per Master Carton	DP 4580, DP 5570, DP 6570, DP 8070, e-STUDIO 55, e-STUDIO 65, e-STUDIO 80	<i>Priced per Drum, sold per Drum.</i>
N/P/N	43019844 	<b>Drum Cartridge Rebuild Kit</b> Kit Contains: • (1) OPC Drum • (1) Drum Cleaning Blade • (1) Drum Fixing Plate • (1) Cleaning Unit F/R Side Seals This drum kit is packaged for use in Sharp, but is approved for use in these Toshiba models. 12 OPC Kits per Master Carton	e-STUDIO 12, e-STUDIO 15	<i>Priced per OPC Kit, sold per OPC Kit.</i>













OEM PN	KATUN PN	DESCRIPTION	MODEL NO.
--------	----------	-------------	-----------

## Photoreceptors















OD1200	43018639 	<b>OPC Drum</b>  Kit Contains: <ul style="list-style-type: none"> <li>• (1) OPC Drum</li> <li>• (1) Drum Fixing Plate</li> </ul> This drum kit is packaged for use in Sharp, but is approved for use in these Toshiba models. 20 OPC Kits per Master Carton	e-STUDIO 12, e-STUDIO 15, E-STUDIO 120, E-STUDIO 150	<i>Priced per OPC Kit, sold per OPC Kit.</i>
OD1600	43022847 	<b>OPC Drum</b>  50 Drums per Master Carton	e-STUDIO 16, e-STUDIO 16 s, e-STUDIO 20, e-STUDIO 20 s, e-STUDIO 25, e-STUDIO 25 s	<i>Priced per Drum, sold per Drum.</i>
OD3500	43021679 	<b>OPC Drum</b>  12 Drums per Master Carton	e-STUDIO 28, e-STUDIO 35, e-STUDIO 45, E-STUDIO 350, E-STUDIO 450	<i>Priced per Drum, sold per Drum.</i>
OD6510	43023019 	<b>OPC Drum</b> 400 K 460 K 500 K 6 Drums per Master Carton	E-STUDIO 550 E-STUDIO 650 E-STUDIO 810	<i>Priced per Drum, sold per Drum.</i>

For use in  
**Toshiba**  
 Copiers

**Central/Eastern Europe**  
 Telephone: 31(0)183-696969  
 Fax: 31(0)183-629055  
 E-mail: order@edc.katun.com



















OEM PN	KATUN PN	DESCRIPTION	MODEL NO.	
<b>Picker Fingers</b>				
4400 852220	43015282 	<b>Upper Picker Finger</b>	1650, 1710, 2050, 2310, 2500, 2510, 2540, 2550, 3210, 3220, 3240, 3550, 3850 D, 4010, 4550, 5010, 5020, BD 7910	<i>Priced per Picker Finger, sold in Packages of 6.</i>
4400 802280	43015912 	<b>Lower Picker Finger</b>	1650, 1710, 2050, 2310, 2500, 2510, 2540, 2550, 3210, 3220, 3240, 3550, 3850 D, 4010, 4550, BD 4910, BD 5110, BD 5120, BD 5910, BD 7610	<i>Priced per Picker Finger, sold in Bags of 5.</i>
4402 085100	43017439 	<b>Drum Picker Finger</b>	2060, 2860, 2870, 3550, 3560, 3570, 4550, 4560, 4570	
4401 952060	43016679 	<b>Upper Picker Finger</b>	2060, 2860, 2870, DP 2460	<i>Priced per Picker Finger, sold in Packages of 6.</i>
4402 491630	43016679 	<b>Upper Picker Finger</b>	3560, 3570, DP 3580, DP 4580, DP 5570, DP 6570, DP 8070, e-STUDIO 55, e-STUDIO 65, e-STUDIO 80, E-STUDIO 550, E-STUDIO 650, E-STUDIO 810	<i>Priced per Picker Finger, sold in Packages of 6.</i>
4408 631300	43017587 	<b>Drum Picker Finger</b>	3850 D, DP 2460, DP 3580	<i>Priced per Picker Finger, sold in Boxes of 6.</i>
4402 444450	43016678 	<b>Upper Picker Finger</b>	4560, 4570	<i>Priced per Picker Finger, sold in Packages of 6.</i>
4401 759400	43015629 	<b>Upper Picker Finger</b>	5540, 5560, 6550, 6560, 7550, 7560, 7650, 7660	<i>Priced per Picker Finger, sold in Packages of 6.</i>
4401 762580	43019951 	<b>Drum Picker Finger</b>	5540, 6550, 6560, 7550, 7560, 7650, 7660, DP 4580, DP 5570, DP 6570, DP 8070, e-STUDIO 55, e-STUDIO 65, e-STUDIO 80, E-STUDIO 550, E-STUDIO 650, E-STUDIO 810	<i>Priced per Picker Finger, sold in Bags of 2.</i>
25AA53160 <i>Final Inventory</i>	43013477 	<b>Upper Picker Finger</b>	9260	<i>Priced per Set, 10 Picker Fingers per Set.</i>
4407 958300 <i>Final Inventory</i>	43011086 	<b>Upper Picker Finger</b>	BD 5110, BD 5120, BD 5610, BD 5620, BD 5910, BD 7610, BD 7720, BD 8510	<i>Priced per Picker Finger, sold in Packages of 6.</i>
44202 983000	43021798 	<b>Upper Picker Finger</b>	e-STUDIO 28, e-STUDIO 35, e-STUDIO 45, E-STUDIO 350, E-STUDIO 450	<i>Priced per Picker Finger, sold in Boxes of 6.</i>
AD025022	43015660 	<b>Drum Picker Finger</b>	E-STUDIO 900, E-STUDIO 1050	<i>Priced per Picker Finger, sold in Packages of 6.</i>



OEM PN	KATUN PN	DESCRIPTION	MODEL NO.
<b>Rollers, Fuser/Heat</b>			
HR 1210 U	43010231 	<b>Upper Fuser Roller DURACON™ II</b>	1210, 1340, 1350, 1360, 1370
HR 1350 U	43010231 	<b>Upper Fuser Roller DURACON™ II</b>	1210, 1340, 1350, 1360, 1370
HR 24 TAU	43636747 	<b>Upper Fuser Roller DURAPREM™ II</b>	1310, BD 3810, BD 3910
HR 1550 U	43015780 	<b>Upper Fuser Roller</b> OEM Type	1550, 1560
4409 899050	43014790 	<b>Upper Fuser Roller</b> OEM Type	1650, 2050, 2540
HR 2050 UN	43014790 	<b>Upper Fuser Roller</b> OEM Type	1650, 2050, 2540
HR 2510 UN	43014469 	<b>Upper Fuser Roller</b> OEM Type	1710, 2310, 2500, 2510, 2550
HR 2510 UN	43014837	<b>Upper Fuser Roller</b> <b>Access By Katun</b>	1710, 2310, 2500, 2510, 2550
HR 2060 U	43015656 	<b>Upper Fuser Roller</b> <b>TRITON™ II</b> Improved Toner Release Characteristics	2060, 2860, 2870, DP 2460, DP 2570
HR 3240 U	43010232 	<b>Upper Fuser Roller</b> <b>DURACON™ II</b>	3210, 3240
HR 4010 U	43011240 	<b>Upper Fuser Roller</b> <b>DURACON™ II</b>	3220, 4010
HR 4010 U	43014835	<b>Upper Fuser Roller</b> <b>Access By Katun</b>	3220, 4010
HR 3550 U	43011240 	<b>Upper Fuser Roller</b> <b>DURACON™ II</b>	3550, 3850 D
HR 3550 U	43014835	<b>Upper Fuser Roller</b> <b>Access By Katun</b>	3550, 3850 D
HR 3560 U	43015656 	<b>Upper Fuser Roller</b> <b>TRITON™ II</b> Improved Toner Release Characteristics	3560, 3570
HR 4550 U	43012625 	<b>Upper Fuser Roller</b> <b>ALUMANA™</b> Patented TEFLON® coating with reinforcing oxides extends life.	4550
HR 4560 U	43016122 	<b>Upper Fuser Roller</b> OEM Type	4560, 4570
HR 6550 U	43012041 	<b>Upper Fuser Roller</b> <b>ALUMANA™</b> Patented TEFLON® coating with reinforcing oxides extends life.	5540, 6550
HR 6550 U	43014836	<b>Upper Fuser Roller</b> <b>Access By Katun</b>	5540, 6550

For use in  
**Toshiba**  
 Copiers





















**Central/Eastern Europe**  
 Telephone: 31(0)183-696969  
 Fax: 31(0)183-629055  
 E-mail: order@edc.katun.com

OEM PN	KATUN PN	DESCRIPTION	MODEL NO.
<b>Rollers, Fuser/Heat</b>			
HR 7550 U	43012041 	<b>Upper Fuser Roller ALUMANA™</b> Patented TEFLON® coating with reinforcing oxides extends life.	5560, 6560, 7550, 7560, 7650, 7660
HR 7550 U	43014836	<b>Upper Fuser Roller Access By Katun</b>	5560, 6560, 7550, 7560, 7650, 7660
HR 8050 U <i>Final Inventory</i>	43011285 	<b>Upper Fuser Roller ALUMANA™</b> Patented TEFLON® coating with reinforcing oxides extends life.	8050
HR 24 TBU	43010231 	<b>Upper Fuser Roller DURACON™ II</b>	BD 2810
4409 829120 <i>Final Inventory</i>	43010559 	<b>Upper Fuser Roller ALUMANA™</b> Patented TEFLON® coating with reinforcing oxides extends life.	BD 9230, BD 9240
HR 60 TBUN <i>Final Inventory</i>	43010559 	<b>Upper Fuser Roller ALUMANA™</b> Patented TEFLON® coating with reinforcing oxides extends life.	BD 9230, BD 9240
HR 1570 U	43018865 	<b>Upper Fuser Roller</b>	DP 1570, DP 1570 F, DP 1870 F
HR 3580 U	43018008 	<b>Upper Fuser Roller</b>	DP 3580
4409 892750	43018456 	<b>Upper Fuser Roller ALUMANA™</b> Patented TEFLON® coating with reinforcing oxides extends life.	DP 4580, DP 5570, DP 6570, DP 8070, e-STUDIO 55, e-STUDIO 65, e-STUDIO 80
NROLI0014QSZZ	43015641 	<b>Upper Fuser Roller OEM Type</b>	e-STUDIO 12
NROLI0014QSZ2	43015641 	<b>Upper Fuser Roller OEM Type</b>	e-STUDIO 15
HR1600UN	43023316 	<b>Upper Fuser Roller TRITON™ II</b>	e-STUDIO 16, e-STUDIO 16 s
HR2500U	43023316 	<b>Upper Fuser Roller TRITON™ II</b>	e-STUDIO 20, e-STUDIO 20 s, e-STUDIO 25, e-STUDIO 25 s
HR3500U	43020103 	<b>Upper Fuser Roller</b>	e-STUDIO 28, e-STUDIO 35, e-STUDIO 45
6LA58 628800	43015641 	<b>Upper Fuser Roller OEM Type</b>	E-STUDIO 120, E-STUDIO 150
FR FC31 U	43023878 	<b>Upper Fuser Roller Foam Type</b>	e-STUDIO 210 c, e-STUDIO 310 c
HR8110U	43023749 	<b>Upper Fuser Roller DURACON™ II</b>	E-STUDIO 550, E-STUDIO 650, E-STUDIO 810
AE011056	43023678 	<b>Upper Fuser Roller TRITON BLUE™</b>	E-STUDIO 900, E-STUDIO 1050
HR FC22 U	43021948 	<b>Upper Fuser Roller MICROSLEEVE™</b>	FC 15, FC 15 i, FC 22, FC 22 i



Katun Performance Product

© 2004 Katun Corporation

OEM PN	KATUN PN	DESCRIPTION	MODEL NO.
<b>Rollers, Pressure</b>			
HR 1210 L	43020958 	Lower Pressure Roller MICROSLEEVE™	1210, 1340, 1350, 1360, 1370
HR 2510 L	43009126 	Lower Pressure Roller MICROSLEEVE™	1550, 1560, 1650, 1710, 2050, 2310, 2500, 2510, 2540, 2550, 3210
HR 2060 L	43018879 	Lower Pressure Roller MICROSLEEVE™	2060, 2860, 2870, DP 2460, DP 2570
HR 3240 L	43009126 	Lower Pressure Roller MICROSLEEVE™	3210, 3240
HR 3550 L <i>Final Inventory</i>	43009125 	Lower Pressure Roller MICROSLEEVE™	3220, 3550, 3850 D, 4010
HR 4010 L <i>Final Inventory</i>	43009125 	Lower Pressure Roller MICROSLEEVE™	3220, 3550, 3850 D, 4010
HR 3560 L	43018879 	Lower Pressure Roller MICROSLEEVE™	3560, 3570
HR 4560 L	43020959 	Lower Pressure Roller MICROSLEEVE™	4560, 4570
HR 6550 L	43011901 	Lower Pressure Roller MICROSLEEVE™	5540, 5560, 6550, 6560, 7550, 7560, 7650, 7660
HR 8050 L	43011053 	Lower Pressure Roller MICROSLEEVE™	8050
25AA53060 <i>Final Inventory</i>	43016067 	Lower Pressure Roller MICROSLEEVE™	9260
25AA53061 <i>Final Inventory</i>	43016067 	Lower Pressure Roller MICROSLEEVE™	9260
HR 60 RAL <i>Final Inventory</i>	43636757 	Lower Pressure Roller	BD 9100, BD 9110, BD 9230, BD 9240
2AB93040	43018322 	Lower Pressure Roller MICROSLEEVE™	DP 1870 F
HR 3580 L	43019614 	Lower Pressure Roller MICROSLEEVE™	DP 3580
HR 6570 L	43018320 	Lower Pressure Roller MICROSLEEVE™	DP 4580, DP 5570, DP 6570, DP 8070, e-STUDIO 55, e-STUDIO 65, e-STUDIO 80
41330 540600	43019610 	Lower Pressure Roller	e-STUDIO 12, e-STUDIO 15, E-STUDIO 120, E-STUDIO 150
NROLR0028QSZZ	43019610 	Lower Pressure Roller	e-STUDIO 12, e-STUDIO 15, E-STUDIO 120, E-STUDIO 150
HR1600L	43020758 	Lower Pressure Roller MICROSLEEVE™	e-STUDIO 16, e-STUDIO 16 s
HR2500L	43020759 	Lower Pressure Roller MICROSLEEVE™	e-STUDIO 20, e-STUDIO 20 s, e-STUDIO 25, e-STUDIO 25 s
HR3500L	43022695 	Lower Pressure Roller MICROSLEEVE™	e-STUDIO 28, e-STUDIO 35, e-STUDIO 45

For use in  
**Toshiba**  
Copiers



**Central/Eastern Europe**  
Telephone: 31(0)183-696969  
Fax: 31(0)183-629055  
E-mail: [order@edc.katun.com](mailto:order@edc.katun.com)



OEM PN	KATUN PN	DESCRIPTION	MODEL NO.
-----------	-------------	-------------	--------------

---

**Rollers, Pressure**









---











HR FC31 L	43023851 	Lower Pressure Roller	e-STUDIO 210 c, e-STUDIO 310 c
HR8110L	43023611 	Lower Pressure Roller MICROSLEEVE™	E-STUDIO 550, E-STUDIO 650, E-STUDIO 810

OEM PN	KATUN PN	DESCRIPTION	MODEL NO.
<b>Thermal Control Devices</b>			
4400 968820	43013713 	<b>Thermistor</b>	1650, 1710, 2050, 2310, 2500, 2510, 2540, 2550
4401 916840	43021953 	<b>Thermal Fuse</b>	6560, 7550, 7560, 7650, 7660, DP 4580, DP 5570, DP 6570, DP 8070, e-STUDIO 55, e-STUDIO 65, e-STUDIO 80

For use in  
**Toshiba**  
 Copiers















**Central/Eastern Europe**  
 Telephone: 31(0)183-696969  
 Fax: 31(0)183-629055  
 E-mail: order@edc.katun.com

OEM PN	KATUN PN	DESCRIPTION	MODEL NO.
<b>Toners/Toner Cartridges</b>			
T 120PE	43017402 	<b>Black Toner</b> 145 g / Cartridge 1 Box (10 Cartridges) per Master Carton	1210, BD 2810  <i>Priced per Cartridge, sold in Boxes of 10.</i>
T 120PE	43013302	<b>Black Toner</b> <b>Original</b> 145 g / Cartridge	1210, BD 2810  <i>Priced per Cartridge, sold in Boxes of 10.</i>
T 85P	43017425 	<b>Black Toner</b> 200 g / Cartridge 1 Box (10 Cartridges) per Master Carton	1310, BD 3810, BD 3910  <i>Priced per Cartridge, sold in Boxes of 10.</i>
T1350	43017390 	<b>Black Toner</b> 180 g / Cartridge 3 teeth on drive coupler 1 Box (4 Cartridges) per Master Carton	1340, 1350, 1360, 1370  <i>Priced per Cartridge, sold in Boxes of 4.</i>
T1350 E	43017392 	<b>Black Toner</b> 180 g / Cartridge 2 teeth on drive coupler 1 Box (4 Cartridges) per Master Carton	1340, 1350, 1360, 1370  <i>Priced per Cartridge, sold in Boxes of 4.</i>
T1350 E	43014634	<b>Black Toner</b> <b>Original</b> 180 g / Cartridge	1340, 1350, 1360, 1370  <i>Priced per Cartridge, sold in Boxes of 4.</i>
T1550	43017382 	<b>Black Toner</b> 240 g / Cartridge 3 tabs on drive coupler 1 Box (4 Cartridges) per Master Carton	1550, 1560  <i>Priced per Cartridge, sold in Boxes of 4.</i>
T1550 E	43017384 	<b>Black Toner</b> 240 g / Cartridge 4 tabs on drive coupler 1 Box (4 Cartridges) per Master Carton	1550, 1560  <i>Priced per Cartridge, sold in Boxes of 4.</i>
T1550 E	43014429	<b>Black Toner</b> <b>Original</b> 240 g / Cartridge	1550, 1560  <i>Priced per Cartridge, sold in Boxes of 4.</i>
T2050 E	43017394 	<b>Black Toner</b> 300 g / Cartridge 1 Box (4 Cartridges) per Master Carton	1650, 2050, 2540  <i>Priced per Cartridge, sold in Boxes of 4.</i>
T2050 E	43013439	<b>Black Toner</b> <b>Original</b> 300 g / Cartridge	1650, 2050, 2540  <i>Priced per Cartridge, sold in Boxes of 4.</i>
T1710	43017394 	<b>Black Toner</b> 300 g / Cartridge 1 Box (4 Cartridges) per Master Carton	1710, 2310, 2500  <i>Priced per Cartridge, sold in Boxes of 4.</i>
T1710	43013337	<b>Black Toner</b> <b>Original</b> 300 g / Cartridge	1710, 2310, 2500  <i>Priced per Cartridge, sold in Boxes of 4.</i>

OEM PN	KATUN PN	DESCRIPTION	MODEL NO.	
<b>Toners/Toner Cartridges</b>				
T2060	43017386 	<b>Black Toner</b> 300 g / Cartridge 3 teeth on drive coupler 1 Box (4 Cartridges) per Master Carton	2060, 2860, 2870	<i>Priced per Cartridge, sold in Boxes of 4.</i>
T2060 E	43017388 	<b>Black Toner</b> 300 g / Cartridge 2 teeth on drive coupler 1 Box (4 Cartridges) per Master Carton	2060, 2860, 2870	<i>Priced per Cartridge, sold in Boxes of 4.</i>
T2060 E	43017257	<b>Black Toner</b> <b>Original</b> 300 g / Cartridge	2060, 2860, 2870	<i>Priced per Cartridge, sold in Boxes of 4.</i>
T2510	43017398 	<b>Black Toner</b> 450 g / Cartridge 1 Box (4 Cartridges) per Master Carton	2510, 2550	<i>Priced per Cartridge, sold in Boxes of 4.</i>
T3210	43017396 	<b>Black Toner</b> 420 g / Cartridge 1 Box (4 Cartridges) per Master Carton	3210, 3240	<i>Priced per Cartridge, sold in Boxes of 4.</i>
T4010 P	43017398 	<b>Black Toner</b> 450 g / Cartridge 1 Box (4 Cartridges) per Master Carton	3220, 4010	<i>Priced per Cartridge, sold in Boxes of 4.</i>
T4550 E	43017400 	<b>Black Toner</b> 550 g / Cartridge 1 Box (4 Cartridges) per Master Carton	3550, 4550	<i>Priced per Cartridge, sold in Boxes of 4.</i>
T3560	43016488 	<b>Black Toner</b> 500 g / Cartridge 3 teeth on drive coupler 1 Box (4 Cartridges) per Master Carton	3560, 3570, 4560, 4570	<i>Priced per Cartridge, sold in Boxes of 4.</i>
T3560E	43016491 	<b>Black Toner</b> 500 g / Cartridge 2 teeth on drive coupler 1 Box (4 Cartridges) per Master Carton	3560, 3570, 4560, 4570	<i>Priced per Cartridge, sold in Boxes of 4.</i>
T6550 E	43012645 	<b>Black Toner</b> 1200 g / Cartridge 1 Box (4 Cartridges) per Master Carton	5540, 6550	<i>Priced per Cartridge, sold in Boxes of 4.</i>
T6560 E	43018845 	<b>Black Toner</b> 1350 g / Cartridge 1 Box (4 Cartridges) per Master Carton	5560, 6560	<i>Priced per Cartridge, sold in Boxes of 4.</i>
T6560 E	43018502	<b>Black Toner</b> <b>Original</b> 1200 g / Cartridge	5560, 6560	<i>Priced per Cartridge, sold in Boxes of 4.</i>
T 220P	43017423 	<b>Black Toner</b> 375 g / Cartridge 1 Box (10 Cartridges) per Master Carton	BD 4910, BD 5910, BD 7910	<i>Priced per Cartridge, sold in Boxes of 10.</i>

For use in  
**Toshiba**  
 Copiers

**Central/Eastern Europe**  
 Telephone: 31(0)183-696969  
 Fax: 31(0)183-629055  
 E-mail: order@edc.katun.com

OEM PN	KATUN PN	DESCRIPTION	MODEL NO.
<b>Toners/Toner Cartridges</b>			
T 80P	43017429 	<b>Black Toner</b> 265 g / Cartridge 1 Box (10 Cartridges) per Master Carton	BD 5110, BD 5120  <i>Priced per Cartridge, sold in Boxes of 10.</i>
T 62P <i>Final Inventory</i>	43017433 	<b>Black Toner</b> 250 g / Cartridge 1 Box (10 Cartridges) per Master Carton	BD 5610, BD 5620  <i>Priced per Cartridge, sold in Boxes of 10.</i>
T 64P	43017429 	<b>Black Toner</b> 265 g / Cartridge 1 Box (10 Cartridges) per Master Carton	BD 7610, BD 7720  <i>Priced per Cartridge, sold in Boxes of 10.</i>
T 68P	43017421 	<b>Black Toner</b> 275 g / Bottle 1 Box (10 Bottles) per Master Carton	BD 9100, BD 9110, BD 9230, BD 9240  <i>Priced per Bottle, sold in Boxes of 10.</i>
T2460E	43020080 	<b>Black Toner</b> 300 g / Cartridge 2 teeth on drive coupler 1 Box (4 Cartridges) per Master Carton	DP 2460, DP 2570  <i>Priced per Cartridge, sold in Boxes of 4.</i>
T3580E	43020079 	<b>Black Toner</b> 300 g / Cartridge 2 teeth on drive coupler 1 Box (4 Cartridges) per Master Carton	DP 3580  <i>Priced per Cartridge, sold in Boxes of 4.</i>
T6570E	43020078 	<b>Black Toner</b> 1500 g / Cartridge 1 Box (4 Cartridges) per Master Carton	DP 4580, DP 5570, DP 6570, DP 8070, e-STUDIO 55, e-STUDIO 65, e-STUDIO 80  <i>Priced per Cartridge, sold in Boxes of 4.</i>
T1200	43023317 	<b>Black Toner</b> 210 g / Cartridge 10 Cartridges per Master Carton	e-STUDIO 12, e-STUDIO 15, E-STUDIO 120, E-STUDIO 150  <i>Priced per Cartridge, sold per Cartridge.</i>
T1200E	43023317 	<b>Black Toner</b> 210 g / Cartridge 10 Cartridges per Master Carton	e-STUDIO 12, e-STUDIO 15, E-STUDIO 120, E-STUDIO 150  <i>Priced per Cartridge, sold per Cartridge.</i>
T1600D	43023239 	<b>Black Toner</b> 500 g / Cartridge 6 Cartons (12 Cartridges) per Master Carton	e-STUDIO 16, e-STUDIO 16 s, E-STUDIO 160  <i>Priced per Cartridge, sold in Cartons of 2.</i>
T1600E	43023239 	<b>Black Toner</b> 500 g / Cartridge 6 Cartons (12 Cartridges) per Master Carton	e-STUDIO 16, e-STUDIO 16 s, E-STUDIO 160  <i>Priced per Cartridge, sold in Cartons of 2.</i>
T2500D	43023239 	<b>Black Toner</b> 500 g / Cartridge 6 Cartons (12 Cartridges) per Master Carton	e-STUDIO 20, e-STUDIO 20 s, e-STUDIO 25, e-STUDIO 25 s, E-STUDIO 200, E-STUDIO 250  <i>Priced per Cartridge, sold in Cartons of 2.</i>
T2500E	43023239 	<b>Black Toner</b> 500 g / Cartridge 6 Cartons (12 Cartridges) per Master Carton	e-STUDIO 20, e-STUDIO 20 s, e-STUDIO 25, e-STUDIO 25 s, E-STUDIO 200, E-STUDIO 250  <i>Priced per Cartridge, sold in Cartons of 2.</i>
T3500E	43022261 	<b>Black Toner</b> 450 g / Cartridge Black cartridge dispensing cap 1 Box (4 Cartridges) per Master Carton	e-STUDIO 28, e-STUDIO 35, e-STUDIO 45  <i>Priced per Cartridge, sold in Boxes of 4.</i>

Central/Eastern Europe  
Telephone: 31(0)183-696969  
Fax: 31(0)183-629055  
E-mail: order@edc.katun.com

For use in  
**Toshiba**  
Copiers

OEM PN	KATUN PN	DESCRIPTION	MODEL NO.
-----------	-------------	-------------	--------------

## Toners/Toner Cartridges



N/P/N	43021362 	<b>Black Toner</b> 225 g / Bottle Includes: <ul style="list-style-type: none"><li>• (1) Pour Spout</li></ul> This toner is packaged for use in Sharp, but is approved for use in these Toshiba models. 10 Bottles per Master Carton	E-STUDIO 120, E-STUDIO 150	<i>Priced per Carton, 10 Bottles per Carton.</i>
-------	---	--	----------------------------	--

For use in  
**Toshiba**  
 Copiers

**Central/Eastern Europe**  
 Telephone: 31(0)183-696969  
 Fax: 31(0)183-629055  
 E-mail: order@edc.katun.com

OEM PN	KATUN PN	DESCRIPTION	MODEL NO.
-----------	-------------	-------------	--------------

### Waste Toner Containers

TB 6550 E	43022090 	<b>Disposable Toner Cartridge</b>	5540, 5560, 6550, 6560, 7550, 7560, 7650, 7660, DP 4580, DP 5570, DP 6570, DP 8070, e-STUDIO 55, e-STUDIO 65, e-STUDIO 80
TB3500	43022951 	<b>Disposable Toner Cartridge</b> Cap included	e-STUDIO 28, e-STUDIO 35, e-STUDIO 45

*Priced per waste toner btl,  
 sold in Boxes of 4.*



## General Information

### Credit Terms and Ordering Information

#### Credit Terms

Standard credit terms are net-30-days from date of invoice. To open a net-30-day account, please contact the Katun Credit Department. Until your credit application is approved, orders will be shipped upon receipt of cash in advance or a confirmed, Sight Draft, or via C.O.D. (Nominal C.O.D. handling charges will apply.)

Katun offers a 3% cash-with-order (CWO) discount. Katun will calculate the 3% discount, promptly inform you of the total charges, and ship your order immediately upon receipt of your payment.

#### Place all orders with Katun (E.D.C.) B.V. via:

- Telephone: 31(0) 183–696969
- Fax: 31(0) 183–629055
- E-mail: order@edc.katun.com
- Address:

**Katun (E.D.C.) B.V.**  
**Edisonweg 44**  
**4207 HG Gorinchem**  
**The Netherlands**

Reference Katun part numbers on all orders.

Prices are in Euro, EX WORKS Gorinchem, The Netherlands.

Katun business hours are from 8:30 to 17.00 hours.

Katun has a € 350 minimum order. A € 35 charge will be added to orders under the minimum.

#### Wire transfer funds to:

ABN–AMRO Bank  
Daalsesingel 71  
Postbus 2059  
3500 GB Utrecht  
The Netherlands  
Account Number: 55 70 74 134  
Swift I.D.: ABN ANL 2A  
IBAN: NL51ABNA0557074134

## General Shipping Information and Product Return Policies

### Shipping and Handling

Katun can provide you with alternatives for shipping. We will attempt to select the most convenient and cost-effective carrier for you. However, if you have a preferred carrier, please inform your Katun Customer Service Representative.



## Central/Eastern Europe

Telephone: 31(0)183-696969

Fax: 31(0)183-629055

E-mail: [order@edc.katun.com](mailto:order@edc.katun.com)

Hazardous material shipments will be billed accordingly. A nominal handling charge is incorporated into our shipping costs.

## Product Return Policies

- Katun **must** preauthorize all returns. For return procedures and a return, contact the Customer Service Department at 31(0) 183–696969.
- Toner, toner cartridges, digital duplicator inks and masters, and thermal transfer ribbons with personalized labels cannot be returned to Katun for credit unless a valid warranty claim exists.
- Returns and refused shipments are subject to a minimum 10% restocking charge.
- With the exception of warranty claims, merchandise returned more than 90 days from the invoice date will not be accepted.
- Merchandise which has been written on, marked, relabeled, or placed in other than original Katun packaging will not be accepted.
- All warranty claims submitted to Katun *must* be accompanied by a completed Distributor Choice Warranty Claim Form (included in this catalog). Customers must indicate a warranty choice on the form:
  - (a) Technical Evaluation/ Replacement or technical Evaluation/ Credit: Ship the product and the completed form to:  
**Katun (E.D.C.) B.V.**  
**Edisonweg 44**  
**4207 HG**  
**Gorinchem**  
**The Netherlands**
  - (b) Automatic Replacement: send the completed form to your customer service representative.



## Allgemeine Hinweise

### Zahlungsbedingungen und Bestellinformationen

Die übliche Zahlungsweise ist bar innerhalb von 30 Tagen ab Rechnungsdatum. Zur Eröffnung eines Kontos wenden Sie sich bitte an die Katun Kreditabteilung. Bis zur Gewährung Ihres Kredits erfolgt der Versand von Bestellungen bei Vorkasse oder bei Erhalt eines bestätigten, Sichtwechsel oder gegen Nachnahme (unter Berechnung einer geringen Nachnahmegebühr).

Katun gewährt 3 % Skonto für Barzahlung bei Bestellung. Katun wird den Skontobetrag errechnen, Ihnen den Gesamtbetrag mitteilen und Ihre Bestellung unverzüglich nach Erhalt Ihrer Zahlung zum Versand aufgeben.

Bitte richten Sie alle Bestellungen an Katun (E.D.C.) B.V. unter:

- **Telefon: 31 (0) 183–696969**
- **Fax: 31 (0) 183–629055**
- **E-mail: order@edc.katun.com**
- **Adresse:**

**Katun (E.D.C.) B.V.**  
**Edisonweg 44**  
**NL-4207 HG Gorinchem**  
**Niederlande**

Bitte bei allen Bestellungen die Katun Artikelnummern angeben. Preise verstehen sich in Euro, ab Werk Gorinchem, Niederlande.

Katun Geschäftszeit ist 8.30 - 17.00 Uhr. Für alle Bestellungen gilt ein Mindestbestellwert von € 350. Bei Bestellungen unter dem Mindestbestellwert wird ein Zuschlag von €35 berechnet.

#### Bankverbindung:

ABN AMRO Bank  
Daalsesingel 71  
Postbus 2059  
NL-3500 GB Utrecht  
Niederlande  
Kontonummer: 55 70 74 134  
Bankleitzahl: ABN ANL 2A  
IBAN: NL51ABNA0557074134

### Versand und Warenrücksendung

#### Bearbeitung und Versand

Katun bietet verschiedene Versandmethoden an. Wir bemühen uns, die für Sie günstigste und praktischste Versandart zu wählen. Falls Sie eine bestimmte Versandart/Firma vorziehen, teilen Sie dies bitte Ihrem Katun Repräsentanten mit.

## Central/Eastern Europe

Telephone: 31(0)183-696969

Fax: 31(0)183-629055

E-mail: [order@edc.katun.com](mailto:order@edc.katun.com)

Versandkosten für Gefahrgüter werden entsprechend berechnet. Eine geringe Bearbeitungsgebühr ist in unseren Versandgebühren enthalten.

## Warenrücksendung

- Nur von Katun vorher genehmigte Waren- rücksendungen könnenbearbeitet werden. Bitte lassen Sie sich vom Kundendienst unter der Telefonnummer 31 (0) 183-696969 genaue Anweisungen geben.
- Bei Warenrücksendungen werden 10 % Rücknahmegebühren in Abzug gebracht.
- Toner, Drucker-/Faxkartuschen, Tinten für digitale Duplikatoren sowie Thermo-Transfer-Bänder mit Firmenetiketten sind vom Umtausch ausgeschlossen, es sei denn, es liegt ein Garantiefall for.
- Ware, die nach Ablauf von 90 Tagen ab Rechnungsdatum zurückgeschickt wird, kann nicht zurückgenommen werden (mit Ausnahme von Reklamationen).
- Ware, deren Verpackung markiert, etikettiert oder beschriftet wurde, oder Ware ohne Originalverpackung kann nicht zurückgenommen werden.
- Alle Garantieansprüche müssen von einem ausgefüllten Händler -Garantieformular begleitet sein ( Formular in diesem Katalog enthaltrn). Geben Sie Ihren Regulierungswunsch auf dem Formular an:
  - (a) Technische Bewertung/Ersatz oder Technische Bewertung/Gutschrift: schicken Sie das Produkt und das vollständig ausgefüllte Formular an:

**Katun (E.D.C.) B.V.**  
**Edisonweg 44**  
**NL-4207 HG Gorinchem**  
**Niederlande**
  - (b) Ersatz ohne Bewertung: schicken Sie das vollständig ausgefüllte Formular an Ihren Ansprechpartner der Auftragsbearbeitung.

## DISTRIBUTOR CHOICE WARRANTY CLAIM FORM

*Please print all information. For prompt processing of your claim, please complete all sections. Your feedback is important to the ongoing improvement of Katun products. Thank you.*

### I. WARRANTY CHOICE

*Please check one. See Section 2 on reverse side for additional information.*

Technical Evaluation/Replacement       Technical Evaluation/Credit       Automatic Replacement

### II. CUSTOMER INFORMATION

Customer Number: \_\_\_\_\_ Date Shipped: \_\_\_\_\_

Company Name: \_\_\_\_\_ Delivery Date: \_\_\_\_\_

Address: \_\_\_\_\_

City: \_\_\_\_\_ State/Province: \_\_\_\_\_

Country: \_\_\_\_\_ Postal Code: \_\_\_\_\_

Your Name: \_\_\_\_\_ Title: \_\_\_\_\_

### III. PRODUCT INFORMATION

Katun PN	Quantity	Description	Serial/Lot Number
1) _____	_____	_____	_____
2) _____	_____	_____	_____
3) _____	_____	_____	_____
4) _____	_____	_____	_____
5) _____	_____	_____	_____

### IV. DETAILED REASON(S) FOR CLAIM

Provide specific information for each product claimed, explaining the reason for claim in as much detail as possible. Include machine models, machine log information, and copy/print counts. **See Section 3 on reverse side for additional specific requirements for photoreceptors.**

- 1) \_\_\_\_\_
- 2) \_\_\_\_\_
- 3) \_\_\_\_\_
- 4) \_\_\_\_\_
- 5) \_\_\_\_\_

#### FOR KATUN USE ONLY

Product Warranty Claim No.: \_\_\_\_\_ Pieces: \_\_\_\_\_  
Received By: \_\_\_\_\_ Date: \_\_\_\_\_

## Central/Eastern Europe

Telephone: 31(0)183-696969

Fax: 31(0)183-629055

E-mail: order@edc.katun.com

## PLEASE READ AND COMPLY WITH ALL THESE REQUIREMENTS TO EXPEDITE THE PROCESSING OF YOUR CLAIM.

### 1. General Instructions

A completed copy of this form must accompany all product warranty claims. Please indicate date of product delivery for determination of warranty coverage time period. *Your feedback is important to the ongoing improvement of Katun products. Please complete all sections on the reverse side.*

### 2. Distributor Choice Warranty Claim Options

Please indicate your choice of Technical Evaluation/Replacement, Technical Evaluation/Credit, or Automatic Replacement. **NOTE:** Automatic Replacement claims must be filed within 90 days of product delivery date, and must not exceed US\$500/€ 550.

If no choice is indicated:

- (a) If product is included with this form, this claim will be treated as Technical Evaluation/Replacement.
- (b) If no product is included with this form, and the claim is less than US\$500/€ 550, this claim will be treated as Automatic Replacement.
- (c) If no product is included with this form, and the claim is more than US\$500/€ 550, the claim is invalid.

### 3. Specific Requirements

If damage (for example, a chip or scratch on a photoreceptor) is noted "out-of-box," DO NOT INSTALL THE PRODUCT. No copy/print samples are required. Installing a product with out-of-box damage could void the warranty.

*Include applicable copy/print samples with all claims.* If a photoreceptor is suspected to be defective after machine installation, please attach to this form the copy/print samples indicated below. This will allow a thorough evaluation of the claim. Ensure that neither the form nor copy/print samples will contact the photoreceptor surface during shipment.

**FOR PHOTORECEPTORS USED IN COPIERS**, include:

- (a) Three "sky shot" (open platen; black) copies;
- (b) Three white copies; and
- (c) Three copies of a test pattern.

**NOTE:** If the defect is not visible on the copies indicated above, please attach three copies which clearly show the defect.

**FOR PHOTORECEPTORS USED IN PRINTERS AND PLAIN PAPER FACSIMILES**, include three prints which clearly show the defect.

**IMPORTANT:** The Katun product warranty does not cover damage by operator, technician, or machine (including rotational scratches, gouges, scuff marks, or line scratches).

### 4. Shipping Instructions

ALL PRODUCT RETURNS MUST BE PROPERLY PACKAGED. This includes packaging in the correct individual product box and in a second container with adequate protective packaging material. This is required by all carriers.

**NOTE:** Products damaged in transit to Katun due to inadequate packaging cannot be covered by the Katun product warranty, and will be returned.

**Ship Technical Evaluation claims, freight prepaid, to the address specifically indicated for this purpose in the "General Information" section of the Katun On-Line Catalogue and current printed catalogues.** Katun cannot accept responsibility for product warranty claims sent to any other address. **Send Automatic Replacement Claims to your Katun Customer Service Representative.**



## HÄNDLER-GARANTIEFORMULAR

*Das Formular bitte in Druckschrift ausfüllen. Um eine umgehende Bearbeitung Ihrer Reklamation zu ermöglichen, tragen Sie bitte alle Angaben ein.*

*Ihr Feedback trägt zur weiteren Verbesserung von Katun-Produkten bei. Vielen Dank.*

### I. REGULIERUNGSWUNSCH

*Bitte nur einen ankreuzen. Weitere Informationen finden Sie in Abschnitt 2 auf der Rückseite.*

Technische Bewertung/Ersatz     Technische Bewertung/Gutschrift     Ersatz ohne Bewertung

### II. KUNDENINFORMATIONEN

Kunden-Nr.: \_\_\_\_\_ Versanddatum: \_\_\_\_\_

Firmenname: \_\_\_\_\_ Lieferdatum: \_\_\_\_\_

Straße: \_\_\_\_\_

Postleitzahl: \_\_\_\_\_ Ort: \_\_\_\_\_

Land: \_\_\_\_\_

Ihr Name: \_\_\_\_\_ Titel/Funktion: \_\_\_\_\_

### III. PRODUKTINFORMATIONEN

Katun-Artikel-Nr.	Menge	Bezeichnung	Serien-/Lotnummer
1) _____	_____	_____	_____
2) _____	_____	_____	_____
3) _____	_____	_____	_____
4) _____	_____	_____	_____
5) _____	_____	_____	_____

### IV. AUS WELCHEM GRUND REKLAMIEREN SIE DIE WARE?

Machen Sie bitte zu jedem reklamierten Artikel so ausführliche und genaue Angaben wie möglich. Des weiteren benötigen wir Angaben zum Gerätemodell, eine Kopie des Bordbuches sowie Informationen bezüglich der Anzahl der erstellten Kopien/Ausdrucke des Produktes. **Bitte beachten Sie Punkt 3 auf der Rückseite mit wichtigen Informationen zur Reklamation von Fotorezeptoren.**

1) \_\_\_\_\_

2) \_\_\_\_\_

3) \_\_\_\_\_

4) \_\_\_\_\_

5) \_\_\_\_\_

#### **NUR FÜR DEN INTERNEN GEBRAUCH**

Reklamations-Nr.: \_\_\_\_\_ Stückzahl: \_\_\_\_\_

Entgegengenommen von: \_\_\_\_\_ Eingangsdatum: \_\_\_\_\_

## Central/Eastern Europe

Telephone: 31(0)183-696969

Fax: 31(0)183-629055

E-mail: order@edc.katun.com

## BITTE BEACHTEN SIE FOLGENDE HINWEISE, UM DIE BEARBEITUNG IHRER REKLAMATION ZU BESCHLEUNIGEN.

### 1. Allgemeine Hinweise

Verwenden Sie diesen Mängelbericht bei allen Reklamationen. Geben Sie zur Bestimmung der Garantiefrist bitte das Lieferdatum des Produktes an. *Ihr Feedback trägt zur weiteren Verbesserung von Katun-Produkten bei. Bitte tragen Sie alle Angaben auf der Rückseite vollständig ein.*

### 2. Händler-Garantieoption

Geben Sie bitte Ihren Regulierungswunsch an (Technische Bewertung/Ersatz, Technische Bewertung/Gutschrift oder Ersatz ohne Bewertung.) **BITTE BEACHTEN:** Reklamationen ohne Bewertung müssen innerhalb von 90 Tagen nach dem Lieferdatum des Produktes geltend gemacht werden und dürfen einen Wert von USD 500/Euro 550 nicht überschreiten.

Wenn keine Wahl getroffen wurde:

- (a) Wenn diesem Formular das Produkt beigelegt wurde, wird diese Reklamation als Technische Bewertung/Ersatz bearbeitet.
- (b) Wenn diesem Formular kein Produkt beigelegt wurde und der Wert der Reklamation weniger als USD 500/ Euro 550 beträgt, wird diese Reklamation als Ersatz ohne Bewertung bearbeitet.
- (c) Wenn diesem Formular kein Produkt beigelegt wurde und der Wert der Reklamation mehr als USD 500/ Euro 550 beträgt, besteht kein Anspruch auf Reklamation.

### 3. Spezielle Anforderungen

Wenn Schäden (z.B. Splitter oder Kratzer an einem Fotorezeptor) bereits „beim Auspacken“ festgestellt werden, dann **INSTALLIEREN SIE DAS PRODUKT NICHT.** Testkopien sind nicht erforderlich. Die Installation eines Produktes mit bereits bestehendem Schaden könnte zum Erlöschen Ihrer Garantieansprüche führen.

*Fügen Sie allen Reklamationen entsprechende Testkopien bei.* Wenn ein Fotorezeptor nach der Installation einen Defekt aufzuweisen scheint, legen Sie diesem Formular bitte die nachstehend beschriebenen Testkopien bei, um eine genaue Beurteilung der Mängel zu ermöglichen. Das Formular sowie die Testkopien dürfen bei der Rücksendung auf keinen Fall mit der Oberfläche des Fotorezeptors in Berührung kommen.

**FÜR FOTOREZEPTOREN, DIE IN KOPIERERN BENUTZT WURDEN,** folgende Testkopien beilegen:

- (a) 3 schwarze Kopien (bei offener Vorlagenglas-Abdeckung),
- (b) 3 weiße Kopien und
- (c) 3 Testkopien (vom Testbogen).

**BITTE BEACHTEN:** Ist der Defekt auf diesen Mustern nicht sichtbar, legen Sie bitte 3 Kopien bei, auf denen er deutlich zu erkennen ist.

**FÜR FOTOREZEPTOREN, DIE IN DRUCKERN UND NORMALPAPIER-FAXGERÄTEN BENUTZT WURDEN,** legen Sie bitte 3 Kopien bei, auf denen der Defekt deutlich zu erkennen ist.

**WICHTIG:** Schäden, die durch falsche Bedienung des Endanwenders, durch den Techniker oder das Gerät verursacht wurden (d. h. umlaufende Kratzer, Streifen, Abrieb oder querlaufende Kratzer), sind von der Katun Qualitätsgarantie ausgeschlossen.

### 4. Versandrichtlinien

ALLE TEILE, DIE AN UNS ZURÜCKGESANDT WERDEN, MÜSSEN SACHGEMÄSS VERPACKT SEIN, d. h. in dem entsprechenden Einzelkarton und einem zweiten Karton mit entsprechendem Verpackungsmaterial. Dies betrifft jeglichen Transportweg!

**BITTE BEACHTEN:** Teile, die nicht sachgemäß verpackt werden und uns aus diesem Grunde defekt erreichen, sind von der Katun-Qualitätsgarantie ausgeschlossen und werden nicht angenommen.

**Schicken Sie Ihre Reklamation zur technischen Bewertung (frachtfrei) an die für diese Zwecke im Katun-Online-Katalog und dem gültigen regulären Katalog unter den „allgemeinen Hinweisen“ angegebene Adresse.** Katun übernimmt keinerlei Verantwortung für Reklamationen, die an eine andere Adresse als die oben genannte geschickt werden. **Schicken Sie Reklamation zum Ersatz ohne Bewertung an Ihren Katun-Ansprechpartner.**